

# Spirit Series

## User Manual



Dear Sir / Madam,

Thank you for choosing GCC LaserPro laser systems. You can be assured that this machine meets the highest safety standards while using technological innovations shared by no other laser engraver. The Spirit Series is backed by GCC, a truly international company that is dedicated to help your business grow.

We at GCC are proud to introduce the LaserPro Spirit Series, our most technologically advanced laser engraver to date. This easy to operate machine has been designed with quality, productivity, and safety in mind. With SmartAC™, closed-loop DC servo motor, and the new DuraGuild rail motion System, the Spirit Series is clearly on the cutting edge of all laser systems.

GCC understands that a creative technical background is the key to successful growth in the ever-changing information economy. We have a strong team of R&D experts who propel our company to new heights. From product development to manufacturing, our engineers are dedicated to innovation and quality.

Guiding our solid technical base is a world-class management team. At GCC, our leaders bring together marketing, technical support, research development and distribution experts to create an international network to meet your demands. Over the years, this network has been able to span throughout the globe. Our technical support staff is committed to provide you with impeccable service, and when your business is ready to grow, our team will be there!

Sincerely,

A handwritten signature in black ink, appearing to read 'Leonard Shih', with a stylized flourish at the end.

Leonard Shih  
President of GCC

# Table of Contents

Chapter 1	<b>Safety</b>	1
1.1	Principles of a CO2 Laser	2
1.2	Safety Ratings	2
1.3	The Safety Interlock System	2
1.4	Safety Labels	3
1.5	Safety Measures	34
1.5.1	General Safety	34
1.5.2	Safety Notice for Class 4 Machine	35
1.6	Operating Environment	36
1.7	Noise Test	36
Chapter 2	<b>Unpacking&amp; Contents</b>	38
2.1	Unloading and Unpacking	39
2.2	How to Re-pack the Machine	47
2.3	Contents and Accessories Checklist	50
Chapter 3	<b>Mechanical Overview</b>	51
3.1	Front View	52
3.2	Top View	52
3.3	Right (Profile) View	53
3.4	Left (Profile) View	53
3.5	Rear View	54
Chapter 4	<b>Setup and Installation</b>	55
4.1	Machine Setup	56
4.1.1	Powering Up the Machine	56
4.1.2	Connecting the Computer	56
4.1.2.1	Networking Connectivity Setup	57
4.1.2.2	Ethernet Connectivity Setup	60
4.1.3	USB Storage Setup	70
4.2	Graphics Software Setup	74
4.2.1	Recommended Computer Configuration	74
4.3	Installation of the LaserPro Print Driver	74
4.4	Parallels Desktops for MAC Users	75
4.5	Using Adobe's AP with GCC LaserPro machine	81
4.6	Using Autodesk Inventor with GCC LaserPro machine	84
4.7	Using eCUT Plug-in with GCC Lasers	87
Chapter 5	<b>Operating LaserPro Spirit Series</b>	88
5.1	Using the Hardware	89
5.1.1	Laser Key Switch	89
5.1.2	Adjusting the LCD Display Screen's Contrast Setting	90

5.1.3	Graphic Control Panel Overview .....	91
5.1.4	Graphic Control Panel Navigation Chart .....	93
5.1.5	Graphic Control Panel Function Pages .....	94
5.2	The LaserPro Spirit Series Print Driver .....	132
5.2.1	Page Setup and Orientation .....	132
5.2.2	Color Management .....	133
5.2.3	Using the LaserPro Print Driver .....	134
5.2.3.1	LaserPro Spirit Series Print Driver >> Options Page .....	135
5.2.3.2	Spirit Series Print Driver >> Pen Page .....	143
5.2.3.3	Spirit Series Print Driver >> Advanced Page .....	149
5.2.3.4	Spirit Series Print Driver >> Paper Page .....	156
5.2.3.5	Spirit Series Print Driver >> Language Page .....	159
5.2.3.6	Spirit Series Print Driver >> Raster Page .....	160
5.2.3.7	Spirit Series Print Driver >> Stamp Page .....	163
Chapter 6	<b>Engraving and Cutting Techniques</b> .....	165
6.1	Raster Engraving .....	166
6.3	Vector and Raster .....	167
6.4	Hybrid Laser Engraving, Cutting, Marking (only for Spirit GLS Hybrid with dual lasers configuration) .....	167
6.5	3D Tips .....	169
6.5	Modify Image Settings of Picture for Better Engraving Quality .....	177
Chapter 7	<b>Optional Items</b> .....	182
7.1	Fume Extraction Unit .....	183
7.2	Air Compressor .....	184
7.3	Focus Lens Options .....	187
7.4	Pass-Through Door Options .....	189
7.5	SmartBOX Cutting Accessory .....	191
7.6	Rotary Attachment & Rotary Chuck .....	193
7.7	SmartGUARD Fire Alarm Option .....	202
7.8	SmartAIR Fine / Ultra Nozzles Option .....	205
Chapter 8	<b>Basic Maintenance</b> .....	206
8.1	Suggested Cleaning and Maintenance Supplies .....	207
8.2	Maintaining the Work table and Motion System .....	208
8.2.1	Accessing the Work Table and Motion System .....	208
8.2.2	Cleaning the Work Table and Motion System .....	209
8.2.3	Lubrication of the X & Y Rails .....	210
8.3	Cleaning the Optics System .....	212
8.3.1	Removing the Mirrors .....	212
8.4	Cleaning the Exhaust Duct .....	217
Chapter 9	<b>Basic Troubleshooting</b> .....	218

Chapter 10	<a href="#">Appendix</a>	220
10.1	Glossary	221
10.2	LaserPro Spirit Series Specification Sheet	222

# 1

Chapter 1

---

## Safety

Principles of a CO<sub>2</sub> Laser

Safety Ratings

The Safety Interlock System

Safety Labels

Safety Measures

Operating Environment

## 1.1 Principles of a CO2 Laser

LASER is the acronym for Light Amplification by Stimulated Emission of Radiation. A CO2 laser works by electrically stimulating the molecules within a carbon dioxide gas mixture. When focused through a lens, this highly-intense and invisible beam will vaporize many materials. Depending on the speed and intensity of the projected beam, a CO2 laser may be used to engrave or cut through a wide variety of materials.

## 1.2 Safety Ratings

The LaserPro Spirit, Spirit LS, and Spirit GLS are equipped with a sealed carbon-dioxide laser that emits intense and invisible laser radiation with a wavelength of 10.6 microns in the infrared spectrum. The laser system is designated as a Class 1 laser device, meaning that the system is equipped with key safety features and an enclosed laser head to completely contain the laser under normal use. One of the key safety features found on the LaserPro Spirit, Spirit LS, and Spirit GLS is a Class 2 red beam safety guidance pointer (similar to a laser-pointer presentation pen) allowing the operator to see the exact location where the laser beam will fire.

The LaserPro Spirit GLS Hybrid dual lasers configuration is equipped with dual CO2 and Fiber laser tubes that emits intense and invisible laser radiation with a wavelength of 10.6 microns for CO2 and 1 micron for fiber laser in the infrared spectrum. The laser system is designed as a Class I laser device, meaning that the system is equipped with key safety features and an enclosed laser head to completely contain the laser under normal use. One of the key safety features found on the machine is a Class 3R red dot safety guidance pointer (similar to a laser-pointer presentation pen) allowing the operator to see the exact location where the laser beam will fire

Even though the LaserPro Spirit Series is equipped with the most powerful laser to date, through proper usage and taking necessary hardware safeguards, will make it an extremely safe machine. When the front door and back door are open, machine becomes a Class 4 equipment and users must wear goggles to operate the machine.

## 1.3 The Safety Interlock System

The laser system is equipped with a safety interlock system utilizing magnetic sensors on the top and side access doors, laser-activation and door LED lights on the control panel. The magnetic sensors will deactivate the laser when either door is open. At this time, the “door” LED light found on the control panel will illuminate, indicating an open or improperly closed door. When the laser is in operation, the “laser” LED will illuminate to inform the operator that the laser is activated. If at any time, any of the access doors are open and the “laser” LED is illuminated, IMMEDIATELY unplug the laser system and contact GCC service team for technical support and maintenance instructions.

 <b>WARNING</b>	
•	DO NOT operate the laser system if any component of the safety system is malfunctioning.
•	DO NOT attempt to remove or modify any component of the safety interlock system.

## 1.4 Safety Labels

According to CDRH standards, all fixed or removable covers that allow access to a laser beam must have an appropriate laser warning labels attached to them. These warning labels must be clearly visible to the operator prior to removing the cover. Additional labels must be applied to the interior of the machine and be visible in the event when the covers are removed. A label clearly displaying the manufacturer's name, date of manufacture, description of product, model number, serial number, and compliance statement must be attached to the outer surface of the machine.



In compliance with CDRH standards, the required warning labels are affixed at the time of manufacture to the LaserPro Spirit Series, attached on appropriate locations. These labels are not to be modified in any way or removed for any reason. Please familiarize yourself with the specific labels and their locations on the machine. Below is a list of all the safety labels and their locations on the machine.

### Product Label

This label is located at the right-back side of machine. All the product information such as Serial Number, Model Numbers, Laser Power and Electric power can be found here. Before requiring any further tech support, always provide the service person with the information on this label.

### Spirit

		Serial Number <b>150357</b>
Manufacturer	Great Computer Corporation	
Product	Laser Engraver	
Model	Spirit	
Model Number	SI - 12	
Wavelength	10.57-10.63 $\mu\text{m}$	
Power	CO <sub>2</sub> 12W	
Input	100-240VAC, 50-60Hz, Max 7A	
Manufactured	May 2012	
Class I Laser Product Complies with EN60825-1:2007		
Class II Laser Product Complies with CDRH		
Made in Taiwan		
4F-1., No.236, Fude 2nd Rd., Xizhi Dist., New Taipei City 22151, Taiwan		







Serial Number  
**150357**

Manufacturer	Great Computer Corporation
Product	Laser Engraver
Model	Spirit
ModelNumber	SI - 20V93
Wavelength	9.23-9.31 $\mu\text{m}$
Power	CO <sub>2</sub> 20W
Input	100-240VAC, 50-60Hz, Max 10A
Manufactured	May 2012

Class I Laser Product Complies with EN60825-1:2007  
Class II Laser Product Complies with CDRH  
Made in Taiwan  
4F-1., No.236, Fude 2nd Rd., Xizhi Dist., New Taipei City 22151, Taiwan



Serial Number  
**150357**

Manufacturer	Great Computer Corporation
Product	Laser Engraver
Model	Spirit
ModelNumber	SI - 25
Wavelength	10.57-10.63 $\mu\text{m}$
Power	CO <sub>2</sub> 25W
Input	100-240VAC, 50-60Hz, Max 8A
Manufactured	May 2012

Class I Laser Product Complies with EN60825-1:2007  
Class II Laser Product Complies with CDRH  
Made in Taiwan  
4F-1., No.236, Fude 2nd Rd., Xizhi Dist., New Taipei City 22151, Taiwan



Serial Number  
**150357**

Manufacturer	Great Computer Corporation
Product	Laser Engraver
Model	Spirit
ModelNumber	SI - 30V
Wavelength	10.57-10.63 $\mu\text{m}$
Power	CO <sub>2</sub> 30W
Input	100-240VAC, 50-60Hz, Max 10A
Manufactured	May 2012

Class I Laser Product Complies with EN60825-1:2007  
Class II Laser Product Complies with CDRH  
Made in Taiwan  
4F-1., No.236, Fude 2nd Rd., Xizhi Dist., New Taipei City 22151, Taiwan





Serial Number  
**150357**

Manufacturer	Great Computer Corporation
Product	Laser Engraver
Model	Spirit
Model Number	SI - 40C
Wavelength	10.57-10.63 μm
Power	CO <sub>2</sub> 40W
Input	100-240VAC, 50-60Hz, Max 12A
Manufactured	May 2012

Class I Laser Product Complies with EN60825-1:2007  
 Class II Laser Product Complies with CDRH  
 Made in Taiwan  
 4F-1., No.236, Fude 2nd Rd., Xizhi Dist., New Taipei City 22151, Taiwan



Serial Number  
**150357**

Manufacturer	Great Computer Corporation
Product	Laser Engraver
Model	Spirit
Model Number	SI - 40V
Wavelength	10.57-10.63 μm
Power	CO <sub>2</sub> 40W
Input	100-240VAC, 50-60Hz, Max 12A
Manufactured	May 2012

Class I Laser Product Complies with EN60825-1:2007  
 Class II Laser Product Complies with CDRH  
 Made in Taiwan  
 4F-1., No.236, Fude 2nd Rd., Xizhi Dist., New Taipei City 22151, Taiwan



Serial Number  
**150357**

Manufacturer	Great Computer Corporation
Product	Laser Engraver
Model	Spirit
Model Number	SI - 60Ti
Wavelength	10.57-10.63 μm
Power	CO <sub>2</sub> 60W
Input	100-240VAC, 50-60Hz, Max 15A
Manufactured	May 2012

Class I Laser Product Complies with EN60825-1:2007  
 Class II Laser Product Complies with CDRH  
 Made in Taiwan  
 4F-1., No.236, Fude 2nd Rd., Xizhi Dist., New Taipei City 22151, Taiwan



		Serial Number <b>150357</b>
Manufacturer	Great Computer Corporation	
Product	Laser Engraver	
Model	Spirit	
Model Number	SI - 60Ti93	
Wavelength	9.23-9.31 $\mu\text{m}$	
Power	CO <sub>2</sub> 60W	
Input	100-240VAC, 50-60Hz, Max 15A	
Manufactured	May 2012	
Class I Laser Product Complies with EN60825-1:2007 Class II Laser Product Complies with CDRH Made in Taiwan 4F-1., No.236, Fude 2nd Rd., Xizhi Dist., New Taipei City 22151, Taiwan		  



		Serial Number <b>150357</b>
Manufacturer	Great Computer Corporation	
Product	Laser Engraver	
Model	Spirit	
Model Number	SI -80Ti	
Wavelength	10.57-10.63 $\mu\text{m}$	
Power	CO <sub>2</sub> 80W	
Input	200-240VAC, 50-60Hz, Max 15A	
Manufactured	May 2012	
Class I Laser Product Complies with EN60825-1:2007 Class II Laser Product Complies with CDRH Made in Taiwan 4F-1., No.236, Fude 2nd Rd., Xizhi Dist., New Taipei City 22151, Taiwan		  

		Serial Number <b>150357</b>
Manufacturer	Great Computer Corporation	
Product	Laser Engraver	
Model	Spirit	
Model Number	SI -80GT	
Wavelength	10.57-10.63 $\mu\text{m}$	
Power	CO <sub>2</sub> 80W	
Input	200-240VAC, 50-60Hz, Max 15A	
Manufactured	May 2012	
Class I Laser Product Complies with EN60825-1:2014, EN ISO 13849-1:2015 Class II Laser Product Complies with CDRH Made in Taiwan 4F-1., No.236, Fude 2nd Rd., Xizhi Dist., New Taipei City 22151, Taiwan		  

		Serial Number <b>150357</b>
Manufacturer	Great Computer Corporation	
Product	Laser Engraver	
Model	Spirit	
Model Number	SI - 100TiF	
Wavelength	10.57-10.63 $\mu\text{m}$	
Power	CO <sub>2</sub> 100W	
Input	220-240VAC, 50-60Hz, Max 15A	
Manufactured	May 2012	
Class I Laser Product Complies with EN60825-1:2007 Class II Laser Product Complies with CDRH Made in Taiwan 4F-1., No.236, Fude 2nd Rd., Xizhi Dist., New Taipei City 22151, Taiwan		  

		Serial Number <b>150357</b>
Manufacturer	Great Computer Corporation	
Product	Laser Engraver	
Model	Spirit	
Model Number	SI - 100GT	
Wavelength	10.57-10.63 $\mu\text{m}$	
Power	CO <sub>2</sub> 100W	
Input	220-240VAC, 50-60Hz, Max 20A	
Manufactured	May 2012	
Class I Laser Product Complies with EN60825-1:2014, EN ISO 13849-1:2015 Class II Laser Product Complies with CDRH Made in Taiwan 4F-1., No.236, Fude 2nd Rd., Xizhi Dist., New Taipei City 22151, Taiwan		  

**Spirit LS**

		Serial Number <b>150357</b>
Manufacturer	Great Computer Corporation	
Product	Laser Engraver	
Model	Spirit LS	
Model Number	SLS - 12	
Wavelength	10.57-10.63 $\mu\text{m}$	
Power	CO <sub>2</sub> 12W	
Input	100-240VAC, 50-60Hz, Max 7A	
Manufactured	May 2012	
Class I Laser Product Complies with EN60825-1:2007 Class II Laser Product Complies with CDRH Made in Taiwan 4F-1., No.236, Fude 2nd Rd., Xizhi Dist., New Taipei City 22151, Taiwan		  

**GCC**  
*LaserPro*

Serial Number  
**150357**

Manufacturer	Great Computer Corporation
Product	Laser Engraver
Model	Spirit LS
ModelNumber	SLS - 20V93
Wavelength	9.23-9.31 μm
Power	CO <sub>2</sub> 20W
Input	100-240VAC, 50-60Hz, Max 10A
Manufactured	May 2012

Class I Laser Product Complies with EN60825-1:2007  
Class II Laser Product Complies with CDRH  
Made in Taiwan  
4F-1., No.236, Fude 2nd Rd., Xizhi Dist., New Taipei City 22151, Taiwan

**GCC**  
*LaserPro*

Serial Number  
**150357**

Manufacturer	Great Computer Corporation
Product	Laser Engraver
Model	Spirit LS
ModelNumber	SLS -25
Wavelength	10.57-10.63 μm
Power	CO <sub>2</sub> 25W
Input	100-240VAC, 50-60Hz, Max 8A
Manufactured	May 2012

Class I Laser Product Complies with EN60825-1:2007  
Class II Laser Product Complies with CDRH  
Made in Taiwan  
4F-1., No.236, Fude 2nd Rd., Xizhi Dist., New Taipei City 22151, Taiwan

  

**GCC**  
*LaserPro*

Serial Number  
**150357**

Manufacturer	Great Computer Corporation
Product	Laser Engraver
Model	Spirit LS
ModelNumber	SLS -30V
Wavelength	10.57-10.63 μm
Power	CO <sub>2</sub> 30W
Input	100-240VAC, 50-60Hz, Max 10A
Manufactured	May 2012

Class I Laser Product Complies with EN60825-1:2007  
Class II Laser Product Complies with CDRH  
Made in Taiwan  
4F-1., No.236, Fude 2nd Rd., Xizhi Dist., New Taipei City 22151, Taiwan

  





		Serial Number <b>150357</b>
Manufacturer	Great Computer Corporation	
Product	Laser Engraver	
Model	Spirit LS	
ModelNumber	SLS -40C	
Wavelength	10.57-10.63 μm	
Power	CO <sub>2</sub> 40W	
Input	100-240VAC, 50-60Hz, Max 12A	
Manufactured	May 2012	
Class I Laser Product Complies with EN60825-1:2007 Class II Laser Product Complies with CDRH Made in Taiwan 4F-1., No.236, Fude 2nd Rd., Xizhi Dist., New Taipei City 22151, Taiwan		  

		Serial Number <b>150357</b>
Manufacturer	Great Computer Corporation	
Product	Laser Engraver	
Model	Spirit LS	
ModelNumber	SLS -40V	
Wavelength	10.57-10.63 μm	
Power	CO <sub>2</sub> 40W	
Input	100-240VAC, 50-60Hz, Max 12A	
Manufactured	May 2012	
Class I Laser Product Complies with EN60825-1:2007 Class II Laser Product Complies with CDRH Made in Taiwan 4F-1., No.236, Fude 2nd Rd., Xizhi Dist., New Taipei City 22151, Taiwan		  

		Serial Number <b>150357</b>
Manufacturer	Great Computer Corporation	
Product	Laser Engraver	
Model	Spirit LS	
ModelNumber	SLS -60Ti	
Wavelength	10.57-10.63 μm	
Power	CO <sub>2</sub> 60W	
Input	100-240VAC, 50-60Hz, Max 15A	
Manufactured	May 2012	
Class I Laser Product Complies with EN60825-1:2007 Class II Laser Product Complies with CDRH Made in Taiwan 4F-1., No.236, Fude 2nd Rd., Xizhi Dist., New Taipei City 22151, Taiwan		  

		Serial Number <b>150357</b>
Manufacturer	Great Computer Corporation	
Product	Laser Engraver	
Model	Spirit LS	
Model Number	SLS - 60Ti93	
Wavelength	9.23-9.31 $\mu\text{m}$	
Power	CO <sub>2</sub> 60W	
Input	100-240VAC, 50-60Hz, Max 15A	
Manufactured	May 2012	
Class I Laser Product Complies with EN60825-1:2007 Class II Laser Product Complies with CDRH Made in Taiwan 4F-1., No.236, Fude 2nd Rd., Xizhi Dist., New Taipei City 22151, Taiwan		  

		Serial Number <b>150357</b>
Manufacturer	Great Computer Corporation	
Product	Laser Engraver	
Model	Spirit LS	
Model Number	SLS -80Ti	
Wavelength	10.57-10.63 $\mu\text{m}$	
Power	CO <sub>2</sub> 80W	
Input	200-240VAC, 50-60Hz, Max 15A	
Manufactured	May 2012	
Class I Laser Product Complies with EN60825-1:2007 Class II Laser Product Complies with CDRH Made in Taiwan 4F-1., No.236, Fude 2nd Rd., Xizhi Dist., New Taipei City 22151, Taiwan		  

		Serial Number <b>150357</b>
Manufacturer	Great Computer Corporation	
Product	Laser Engraver	
Model	Spirit LS	
Model Number	SLS -80GT	
Wavelength	10.57-10.63 $\mu\text{m}$	
Power	CO <sub>2</sub> 80W	
Input	200-240VAC, 50-60Hz, Max 15A	
Manufactured	May 2012	
Class I Laser Product Complies with EN60825-1:2014, EN ISO 13849-1:2015 Class II Laser Product Complies with CDRH Made in Taiwan 4F-1., No.236, Fude 2nd Rd., Xizhi Dist., New Taipei City 22151, Taiwan		  

<b>GCC</b> <i>LaserPro</i>		Serial Number <b>150357</b>
Manufacturer	Great Computer Corporation	
Product	Laser Engraver	
Model	Spirit LS	
ModelNumber	SLS -100TiF	
Wavelength	10.57-10.63 μm	
Power	CO <sub>2</sub> 100W	
Input	200-240VAC, 50-60Hz, Max 15A	
Manufactured	May 2012	
Class I Laser Product Complies with EN60825-1:2007 Class II Laser Product Complies with CDRH Made in Taiwan 4F-1., No.236, Fude 2nd Rd., Xizhi Dist., New Taipei City 22151, Taiwan		  

<b>GCC</b> <i>LaserPro</i>		Serial Number <b>150357</b>
Manufacturer	Great Computer Corporation	
Product	Laser Engraver	
Model	Spirit LS	
ModelNumber	SLS -100GT	
Wavelength	10.57-10.63 μm	
Power	CO <sub>2</sub> 100W	
Input	200-240VAC, 50-60Hz, Max 15A	
Manufactured	May 2012	
Class I Laser Product Complies with EN60825-1:2014, EN ISO 13849-1:2015 Class II Laser Product Complies with CDRH Made in Taiwan 4F-1., No.236, Fude 2nd Rd., Xizhi Dist., New Taipei City 22151, Taiwan		  



**Spirit GLS**

		Serial Number <b>150357</b>
Manufacturer	Great Computer Corporation	
Product	Laser Engraver	
Model	Spirit GLS	
Model Number	GLS - 20V93	
Wavelength	9.23-9.31 μm	
Power	CO <sub>2</sub> 20W	
Input	100-240VAC, 50-60Hz, Max 10A	
Manufactured	May 2012	
Class I Laser Product Complies with EN60825-1:2007 Class II Laser Product Complies with CDRH Made in Taiwan 4F-1., No.236, Fude 2nd Rd., Xizhi Dist., New Taipei City 22151, Taiwan		  

		Serial Number <b>150357</b>
Manufacturer	Great Computer Corporation	
Product	Laser Engraver	
Model	Spirit GLS	
Model Number	GLS - 30V	
Wavelength	10.57-10.63 μm	
Power	CO <sub>2</sub> 30W	
Input	100-240VAC, 50-60Hz, Max 10A	
Manufactured	May 2012	
Class I Laser Product Complies with EN60825-1:2007 Class II Laser Product Complies with CDRH Made in Taiwan 4F-1., No.236, Fude 2nd Rd., Xizhi Dist., New Taipei City 22151, Taiwan		  

		Serial Number <b>150357</b>
Manufacturer	Great Computer Corporation	
Product	Laser Engraver	
Model	Spirit GLS	
Model Number	GLS - 40V	
Wavelength	10.57-10.63 μm	
Power	CO <sub>2</sub> 40W	
Input	100-240VAC, 50-60Hz, Max 12A	
Manufactured	May 2012	
Class I Laser Product Complies with EN60825-1:2007 Class II Laser Product Complies with CDRH Made in Taiwan 4F-1., No.236, Fude 2nd Rd., Xizhi Dist., New Taipei City 22151, Taiwan		  

**GCC**  
*LaserPro*

Serial Number  
**150357**

Manufacturer	Great Computer Corporation
Product	Laser Engraver
Model	Spirit GLS
ModelNumber	GLS - 40C
Wavelength	10.57-10.63 μm
Power	CO <sub>2</sub> 40W
Input	100-240VAC, 50-60Hz, Max 12A
Manufactured	May 2012

Class I Laser Product Complies with EN60825-1:2007  
Class II Laser Product Complies with CDRH  
Made in Taiwan  
4F-1., No.236, Fude 2nd Rd., Xizhi Dist., New Taipei City 22151, Taiwan

**GCC**  
*LaserPro*

Serial Number  
**150357**

Manufacturer	Great Computer Corporation
Product	Laser Engraver
Model	Spirit GLS
ModelNumber	GLS - 60Ti93
Wavelength	9.23-9.31 μm
Power	CO <sub>2</sub> 60W
Input	100-240VAC, 50-60Hz, Max 15A
Manufactured	May 2012

Class I Laser Product Complies with EN60825-1:2007  
Class II Laser Product Complies with CDRH  
Made in Taiwan  
4F-1., No.236, Fude 2nd Rd., Xizhi Dist., New Taipei City 22151, Taiwan

**GCC**  
*LaserPro*

Serial Number  
**150357**

Manufacturer	Great Computer Corporation
Product	Laser Engraver
Model	Spirit GLS
ModelNumber	GLS - 60Ti
Wavelength	10.57-10.63 μm
Power	CO <sub>2</sub> 60W
Input	100-240VAC, 50-60Hz, Max 15A
Manufactured	May 2012

Class I Laser Product Complies with EN60825-1:2007  
Class II Laser Product Complies with CDRH  
Made in Taiwan  
4F-1., No.236, Fude 2nd Rd., Xizhi Dist., New Taipei City 22151, Taiwan

**GCC**  
*LaserPro*

Serial Number  
**150357**

Manufacturer	Great Computer Corporation
Product	Laser Engraver
Model	Spirit GLS
ModelNumber	GLS - 80Ti
Wavelength	10.57-10.63 μm
Power	CO <sub>2</sub> 80W
Input	220-240VAC, 50-60Hz, Max 15A
Manufactured	May 2012

Class I Laser Product Complies with EN60825-1:2007  
Class II Laser Product Complies with CDRH  
Made in Taiwan  
4F-1., No.236, Fude 2nd Rd., Xizhi Dist., New Taipei City 22151, Taiwan

**GCC**  
*LaserPro*

Serial Number  
**150357**

Manufacturer	Great Computer Corporation
Product	Laser Engraver
Model	Spirit GLS
ModelNumber	GLS - 80GT
Wavelength	10.57-10.63 μm
Power	CO <sub>2</sub> 80W
Input	220-240VAC, 50-60Hz, Max 15A
Manufactured	May 2012

Class I Laser Product Complies with EN60825-1:2014, EN ISO 13849-1:2015  
Class II Laser Product Complies with CDRH  
Made in Taiwan  
4F-1., No.236, Fude 2nd Rd., Xizhi Dist., New Taipei City 22151, Taiwan

**GCC**  
*LaserPro*

Serial Number  
**150357**





Manufacturer	Great Computer Corporation
Product	Laser Engraver
Model	Spirit GLS
ModelNumber	GLS - 100TiF
Wavelength	10.57-10.63 μm
Power	CO <sub>2</sub> 100W
Input	220-240VAC, 50-60Hz, Max 15A
Manufactured	May 2012





Class I Laser Product Complies with EN60825-1:2007  
Class II Laser Product Complies with CDRH  
Made in Taiwan  
4F-1., No.236, Fude 2nd Rd., Xizhi Dist., New Taipei City 22151, Taiwan

		Serial Number <b>150357</b>
Manufacturer	Great Computer Corporation	
Product	Laser Engraver	
Model	Spirit GLS	
Model Number	GLS - 100GT	
Wavelength	10.57-10.63 $\mu\text{m}$	
Power	CO <sub>2</sub> 100W	
Input	220-240VAC, 50-60Hz, Max 15A	
Manufactured	May 2012	
Class I Laser Product Complies with EN60825-1:2014, EN ISO 13849-1:2015 Class II Laser Product Complies with CDRH Made in Taiwan 4F-1., No.236, Fude 2nd Rd., Xizhi Dist., New Taipei City 22151, Taiwan		
  		

**Spirit GLS Hybrid**

		Serial Number <b>Q53444</b>
Manufacturer	Great Computer Corporation	
Product	Laser Engraver	
Model	Spirit GLS Hybrid	
Model Number	GLS Hybrid-30V/20RMZ	
Wavelength	10.57~10.63 $\mu\text{m}$ and 1064 nm	
Power	CO <sub>2</sub> 30W/Fiber 20W	
Input	100-240VAC, 50-60Hz, Max 10A	
Manufactured	May 2016	
Class I Laser Product Complies with EN60825-1:2014 Class IIIR Laser Product Complies with CDRH Made in Taiwan 4F-1., No.236, Fude 2nd Rd., Xizhi Dist., New Taipei City 22151, Taiwan		
  		

		Serial Number <b>Q53444</b>
Manufacturer	Great Computer Corporation	
Product	Laser Engraver	
Model	Spirit GLS Hybrid	
Model Number	GLS Hybrid-30V/30RMZ	
Wavelength	10.57~10.63 $\mu\text{m}$ and 1064 nm	
Power	CO <sub>2</sub> 30W/Fiber 30W	
Input	100-240VAC, 50-60Hz, Max 10A	
Manufactured	May 2016	
Class I Laser Product Complies with EN60825-1:2014 Class IIIR Laser Product Complies with CDRH Made in Taiwan 4F-1., No.236, Fude 2nd Rd., Xizhi Dist., New Taipei City 22151, Taiwan		
  		

**GCC**  
*LaserPro*

Serial Number  
**Q53444**

Manufacturer	Great Computer Corporation
Product	Laser Engraver
Model	Spirit GLS Hybrid
Model Number	GLS Hybrid-30V/50RMZ
Wavelength	10.57~10.63 μm and 1064 nm
Power	CO <sub>2</sub> 30W/Fiber 50W
Input	100-240VAC, 50-60Hz, Max 10A
Manufactured	May 2016

Class I Laser Product Complies with EN60825-1:2014  
Class IIIR Laser Product Complies with CDRH  
Made in Taiwan  
4F-1., No.236, Fude 2nd Rd., Xizhi Dist., New Taipei City 22151, Taiwan

**GCC**  
*LaserPro*

Serial Number  
**Q53444**

Manufacturer	Great Computer Corporation
Product	Laser Engraver
Model	Spirit GLS Hybrid
Model Number	GLS Hybrid-20JFL
Wavelength	1064 nm
Power	20W
Input	100-240VAC, 50-60Hz, Max 8A
Manufactured	May 2016

Class I Laser Product Complies with EN60825-1:2014, EN ISO 13849-1:2015  
Class II Laser Product Complies with CDRH  
Made in Taiwan  
4F-1., No.236, Fude 2nd Rd., Xizhi Dist., New Taipei City 22151, Taiwan



  

**GCC**  
*LaserPro*

Serial Number  
**Q53444**

Manufacturer	Great Computer Corporation
Product	Laser Engraver
Model	Spirit GLS Hybrid
Model Number	GLS Hybrid-30JFL
Wavelength	1064 nm
Power	30W
Input	100-240VAC, 50-60Hz, Max 8A
Manufactured	May 2016

Class I Laser Product Complies with EN60825-1:2014, EN ISO 13849-1:2015  
Class II Laser Product Complies with CDRH  
Made in Taiwan  
4F-1., No.236, Fude 2nd Rd., Xizhi Dist., New Taipei City 22151, Taiwan

**GCC**  
LaserPro

Serial Number  
**Q53444**

Manufacturer	Great Computer Corporation
Product	Laser Engraver
Model	Spirit GLS Hybrid
ModelNumber	GLS Hybrid-60JFL
Wavelength	1064 nm
Power	60W
Input	100-240VAC, 50-60Hz, Max 8A
Manufactured	May 2016

Class I Laser Product Complies with EN60825-1:2014, EN ISO 13849-1:2015  
 Class II Laser Product Complies with CDRH  
 Made in Taiwan  
 4F-1., No.236, Fude 2nd Rd., Xizhi Dist., New Taipei City 22151, Taiwan

**GCC**  
LaserPro

Serial Number  
**Q53444**

Manufacturer	Great Computer Corporation
Product	Laser Engraver
Model	Spirit GLS Hybrid
ModelNumber	GLS Hybrid-40V/20RMZ
Wavelength	10.57~10.63 μm and 1064 nm
Power	CO <sub>2</sub> 40W/Fiber 20W
Input	100-240VAC, 50-60Hz, Max 12A
Manufactured	May 2016

Class I Laser Product Complies with EN60825-1:2014  
 Class IIIR Laser Product Complies with CDRH  
 Made in Taiwan  
 4F-1., No.236, Fude 2nd Rd., Xizhi Dist., New Taipei City 22151, Taiwan

  

**GCC**  
LaserPro

Serial Number  
**Q53444**

Manufacturer	Great Computer Corporation
Product	Laser Engraver
Model	Spirit GLS Hybrid
ModelNumber	GLS Hybrid-40V/30RMZ
Wavelength	10.57~10.63 μm and 1064 nm
Power	CO <sub>2</sub> 40W/Fiber 30W
Input	100-240VAC, 50-60Hz, Max 12A
Manufactured	May 2016

Class I Laser Product Complies with EN60825-1:2014  
 Class IIIR Laser Product Complies with CDRH  
 Made in Taiwan  
 4F-1., No.236, Fude 2nd Rd., Xizhi Dist., New Taipei City 22151, Taiwan

**GCC**  
*LaserPro*

Serial Number  
**Q53444**

Manufacturer	Great Computer Corporation
Product	Laser Engraver
Model	Spirit GLS Hybrid
ModelNumber	GLS Hybrid-40V/50RMZ
Wavelength	10.57~10.63 μm and 1064 nm
Power	CO <sub>2</sub> 40W/Fiber 50W
Input	100-240VAC, 50-60Hz, Max 12A
Manufactured	May 2016

Class I Laser Product Complies with EN60825-1:2014  
Class IIIR Laser Product Complies with CDRH  
Made in Taiwan  
4F-1., No.236, Fude 2nd Rd., Xizhi Dist., New Taipei City 22151, Taiwan

**GCC**  
*LaserPro*

Serial Number  
**Q53444**

Manufacturer	Great Computer Corporation
Product	Laser Engraver
Model	Spirit GLS Hybrid
ModelNumber	GLS Hybrid-40Vi/20JFL
Wavelength	10.57~10.63 μm and 1064 nm
Power	CO <sub>2</sub> 40W/Fiber 20W
Input	100-240VAC, 50-60Hz, Max 12A
Manufactured	May 2016

Class I Laser Product Complies with EN60825-1:2014, EN ISO 13849-1:2015  
Class II Laser Product Complies with CDRH  
Made in Taiwan  
4F-1., No.236, Fude 2nd Rd., Xizhi Dist., New Taipei City 22151, Taiwan

**GCC**  
*LaserPro*

Serial Number  
**Q53444**

Manufacturer	Great Computer Corporation
Product	Laser Engraver
Model	Spirit GLS Hybrid
ModelNumber	GLS Hybrid-40Vi/30JFL
Wavelength	10.57~10.63 μm and 1064 nm
Power	CO <sub>2</sub> 40W/Fiber 30W
Input	100-240VAC, 50-60Hz, Max 12A
Manufactured	May 2016

Class I Laser Product Complies with EN60825-1:2014, EN ISO 13849-1:2015  
Class II Laser Product Complies with CDRH  
Made in Taiwan  
4F-1., No.236, Fude 2nd Rd., Xizhi Dist., New Taipei City 22151, Taiwan

**GCC**  
*LaserPro*

Serial Number  
**Q53444**

Manufacturer	Great Computer Corporation
Product	Laser Engraver
Model	Spirit GLS Hybrid
Model Number	GLS Hybrid-40Vi/60JFL
Wavelength	10.57~10.63 μm and 1064 nm
Power	CO <sub>2</sub> 40W/Fiber 60W
Input	100-240VAC, 50-60Hz, Max 12A
Manufactured	May 2016

Class I Laser Product Complies with EN60825-1:2014, EN ISO 13849-1:2015  
 Class II Laser Product Complies with CDRH  
 Made in Taiwan  
 4F-1., No.236, Fude 2nd Rd., Xizhi Dist., New Taipei City 22151, Taiwan



  

**GCC**  
*LaserPro*

Serial Number  
**Q53444**

Manufacturer	Great Computer Corporation
Product	Laser Engraver
Model	Spirit GLS Hybrid
Model Number	GLS Hybrid-60Ti/20RMZ
Wavelength	10.57~10.63 μm and 1064 nm
Power	CO <sub>2</sub> 60W/Fiber 20W
Input	100-240VAC, 50-60Hz, Max 15A
Manufactured	May 2016

Class I Laser Product Complies with EN60825-1:2014  
 Class IIIR Laser Product Complies with CDRH  
 Made in Taiwan  
 4F-1., No.236, Fude 2nd Rd., Xizhi Dist., New Taipei City 22151, Taiwan



  

**GCC**  
*LaserPro*

Serial Number  
**Q53444**

Manufacturer	Great Computer Corporation
Product	Laser Engraver
Model	Spirit GLS Hybrid
Model Number	GLS Hybrid-60Ti/30RMZ
Wavelength	10.57~10.63 μm and 1064 nm
Power	CO <sub>2</sub> 60W/Fiber 30W
Input	100-240VAC, 50-60Hz, Max 15A
Manufactured	May 2016

Class I Laser Product Complies with EN60825-1:2014  
 Class IIIR Laser Product Complies with CDRH  
 Made in Taiwan  
 4F-1., No.236, Fude 2nd Rd., Xizhi Dist., New Taipei City 22151, Taiwan





**GCC**  
*LaserPro*

Serial Number  
**Q53444**

Manufacturer	Great Computer Corporation
Product	Laser Engraver
Model	Spirit GLS Hybrid
ModelNumber	GLS Hybrid-60Ti/50RMZ
Wavelength	10.57~10.63 μm and 1064 nm
Power	CO <sub>2</sub> 60W/Fiber 50W
Input	100-240VAC, 50-60Hz, Max 15A
Manufactured	May 2016

Class I Laser Product Complies with EN60825-1:2014  
Class IIIR Laser Product Complies with CDRH  
Made in Taiwan  
4F-1., No.236, Fude 2nd Rd., Xizhi Dist., New Taipei City 22151, Taiwan

**GCC**  
*LaserPro*

Serial Number  
**Q53444**

Manufacturer	Great Computer Corporation
Product	Laser Engraver
Model	Spirit GLS Hybrid
ModelNumber	GLS Hybrid-60Ti/20JFL
Wavelength	10.57~10.63 μm and 1064 nm
Power	CO <sub>2</sub> 60W/Fiber 20W
Input	100-240VAC, 50-60Hz, Max 15A
Manufactured	May 2016

Class I Laser Product Complies with EN60825-1:2014, EN ISO 13849-1:2015  
Class II Laser Product Complies with CDRH  
Made in Taiwan  
4F-1., No.236, Fude 2nd Rd., Xizhi Dist., New Taipei City 22151, Taiwan

**GCC**  
*LaserPro*

Serial Number  
**Q53444**

Manufacturer	Great Computer Corporation
Product	Laser Engraver
Model	Spirit GLS Hybrid
ModelNumber	GLS Hybrid-60Ti/30JFL
Wavelength	10.57~10.63 μm and 1064 nm
Power	CO <sub>2</sub> 60W/Fiber 30W
Input	100-240VAC, 50-60Hz, Max 15A
Manufactured	May 2016

Class I Laser Product Complies with EN60825-1:2014, EN ISO 13849-1:2015  
Class II Laser Product Complies with CDRH  
Made in Taiwan  
4F-1., No.236, Fude 2nd Rd., Xizhi Dist., New Taipei City 22151, Taiwan

**GCC**  
*LaserPro*

Serial Number  
**Q53444**

Manufacturer	Great Computer Corporation
Product	Laser Engraver
Model	Spirit GLS Hybrid
ModelNumber	GLS Hybrid-60Ti/60JFL
Wavelength	10.57~10.63 μm and 1064 nm
Power	CO <sub>2</sub> 60W/Fiber 60W
Input	100-240VAC, 50-60Hz, Max 15A
Manufactured	May 2016

Class I Laser Product Complies with EN60825-1:2014, EN ISO 13849-1:2015  
Class II Laser Product Complies with CDRH  
Made in Taiwan  
4F-1., No.236, Fude 2nd Rd., Xizhi Dist., New Taipei City 22151, Taiwan



  

**GCC**  
*LaserPro*

Serial Number  
**Q53444**

Manufacturer	Great Computer Corporation
Product	Laser Engraver
Model	Spirit GLS Hybrid
ModelNumber	GLS Hybrid-80Ti/20RMZ
Wavelength	10.57~10.63 μm and 1064 nm
Power	CO <sub>2</sub> 80W/Fiber 20W
Input	200-240VAC, 50-60Hz, Max 15A
Manufactured	May 2016

Class I Laser Product Complies with EN60825-1:2014  
Class IIIR Laser Product Complies with CDRH  
Made in Taiwan  
4F-1., No.236, Fude 2nd Rd., Xizhi Dist., New Taipei City 22151, Taiwan



  

**GCC**  
*LaserPro*

Serial Number  
**Q53444**

Manufacturer	Great Computer Corporation
Product	Laser Engraver
Model	Spirit GLS Hybrid
ModelNumber	GLS Hybrid-80Ti/30RMZ
Wavelength	10.57~10.63 μm and 1064 nm
Power	CO <sub>2</sub> 80W/Fiber 30W
Input	200-240VAC, 50-60Hz, Max 15A
Manufactured	May 2016

Class I Laser Product Complies with EN60825-1:2014  
Class IIIR Laser Product Complies with CDRH  
Made in Taiwan  
4F-1., No.236, Fude 2nd Rd., Xizhi Dist., New Taipei City 22151, Taiwan



  

**GCC**  
LaserPro

Serial Number  
**Q53444**

Manufacturer	Great Computer Corporation
Product	Laser Engraver
Model	Spirit GLS Hybrid
ModelNumber	GLS Hybrid-80Ti/50RMZ
Wavelength	10.57~10.63 μm and 1064 nm
Power	CO <sub>2</sub> 80W/Fiber 50W
Input	200-240VAC, 50-60Hz, Max 15A
Manufactured	May 2016

Class I Laser Product Complies with EN60825-1:2014  
Class IIIR Laser Product Complies with CDRH  
Made in Taiwan  
4F-1., No.236, Fude 2nd Rd., Xizhi Dist., New Taipei City 22151, Taiwan

**GCC**  
LaserPro

Serial Number  
**Q53444**

Manufacturer	Great Computer Corporation
Product	Laser Engraver
Model	Spirit GLS Hybrid
ModelNumber	GLS Hybrid-80Ti/20JFL
Wavelength	10.57~10.63 μm and 1064 nm
Power	CO <sub>2</sub> 80W/Fiber 20W
Input	200-240VAC, 50-60Hz, Max 15A
Manufactured	May 2016

Class I Laser Product Complies with EN60825-1:2014, EN ISO 13849-1:2015  
Class II Laser Product Complies with CDRH  
Made in Taiwan  
4F-1., No.236, Fude 2nd Rd., Xizhi Dist., New Taipei City 22151, Taiwan

**GCC**  
LaserPro

Serial Number  
**Q53444**

Manufacturer	Great Computer Corporation
Product	Laser Engraver
Model	Spirit GLS Hybrid
ModelNumber	GLS Hybrid-80Ti/30JFL
Wavelength	10.57~10.63 μm and 1064 nm
Power	CO <sub>2</sub> 80W/Fiber 30W
Input	200-240VAC, 50-60Hz, Max 15A
Manufactured	May 2016

Class I Laser Product Complies with EN60825-1:2014, EN ISO 13849-1:2015  
Class II Laser Product Complies with CDRH  
Made in Taiwan  
4F-1., No.236, Fude 2nd Rd., Xizhi Dist., New Taipei City 22151, Taiwan

		Serial Number <b>Q53444</b>
Manufacturer	Great Computer Corporation	
Product	Laser Engraver	
Model	Spirit GLS Hybrid	
ModelNumber	GLS Hybrid-80Ti/60JFL	
Wavelength	10.57~10.63 μm and 1064 nm	
Power	CO <sub>2</sub> 80W/Fiber 60W	
Input	200-240VAC, 50-60Hz, Max 15A	
Manufactured	May 2016	
Class I Laser Product Complies with EN60825-1:2014, EN ISO 13849-1:2015 Class II Laser Product Complies with CDRH Made in Taiwan 4F-1., No.236, Fude 2nd Rd., Xizhi Dist., New Taipei City 22151, Taiwan		
  		

		Serial Number <b>Q53444</b>
Manufacturer	Great Computer Corporation	
Product	Laser Engraver	
Model	Spirit GLS Hybrid	
ModelNumber	GLS Hybrid-80GT/20RMZ	
Wavelength	10.57~10.63 μm and 1064 nm	
Power	CO <sub>2</sub> 80W/Fiber 20W	
Input	200-240VAC, 50-60Hz, Max 15A	
Manufactured	May 2016	
Class I Laser Product Complies with EN60825-1:2014, EN ISO 13849-1:2015 Class II Laser Product Complies with CDRH Made in Taiwan 4F-1., No.236, Fude 2nd Rd., Xizhi Dist., New Taipei City 22151, Taiwan		
  		





		Serial Number <b>Q53444</b>
Manufacturer	Great Computer Corporation	
Product	Laser Engraver	
Model	Spirit GLS Hybrid	
ModelNumber	GLS Hybrid-80GT/30RMZ	
Wavelength	10.57~10.63 μm and 1064 nm	
Power	CO <sub>2</sub> 80W/Fiber 30W	
Input	200-240VAC, 50-60Hz, Max 15A	
Manufactured	May 2016	
Class I Laser Product Complies with EN60825-1:2014, EN ISO 13849-1:2015 Class II Laser Product Complies with CDRH Made in Taiwan 4F-1., No.236, Fude 2nd Rd., Xizhi Dist., New Taipei City 22151, Taiwan		
  		





		Serial Number <b>Q53444</b>
Manufacturer	Great Computer Corporation	
Product	Laser Engraver	
Model	Spirit GLS Hybrid	
ModelNumber	GLS Hybrid-80GT/50RMZ	
Wavelength	10.57~10.63 μm and 1064 nm	
Power	CO <sub>2</sub> 80W/Fiber 50W	
Input	200-240VAC, 50-60Hz, Max 15A	
Manufactured	May 2016	
Class I Laser Product Complies with EN60825-1:2014, EN ISO 13849-1:2015 Class II Laser Product Complies with CDRH Made in Taiwan 4F-1., No.236, Fude 2nd Rd., Xizhi Dist., New Taipei City 22151, Taiwan		
  		

		Serial Number <b>Q53444</b>
Manufacturer	Great Computer Corporation	
Product	Laser Engraver	
Model	Spirit GLS Hybrid	
ModelNumber	GLS Hybrid-80GT/20JFL	
Wavelength	10.57~10.63 μm and 1064 nm	
Power	CO <sub>2</sub> 80W/Fiber 20W	
Input	200-240VAC, 50-60Hz, Max 15A	
Manufactured	May 2016	
Class I Laser Product Complies with EN60825-1:2014, EN ISO 13849-1:2015 Class II Laser Product Complies with CDRH Made in Taiwan 4F-1., No.236, Fude 2nd Rd., Xizhi Dist., New Taipei City 22151, Taiwan		
  		

		Serial Number <b>Q53444</b>
Manufacturer	Great Computer Corporation	
Product	Laser Engraver	
Model	Spirit GLS Hybrid	
ModelNumber	GLS Hybrid-80GT/30JFL	
Wavelength	10.57~10.63 μm and 1064 nm	
Power	CO <sub>2</sub> 80W/Fiber 30W	
Input	200-240VAC, 50-60Hz, Max 15A	
Manufactured	May 2016	
Class I Laser Product Complies with EN60825-1:2014, EN ISO 13849-1:2015 Class II Laser Product Complies with CDRH Made in Taiwan 4F-1., No.236, Fude 2nd Rd., Xizhi Dist., New Taipei City 22151, Taiwan		
  		

		Serial Number <b>Q53444</b>
Manufacturer	Great Computer Corporation	
Product	Laser Engraver	
Model	Spirit GLS Hybrid	
ModelNumber	GLS Hybrid-80GT/60JFL	
Wavelength	10.57~10.63 μm and 1064 nm	
Power	CO <sub>2</sub> 80W/Fiber 60W	
Input	200-240VAC, 50-60Hz, Max 15A	
Manufactured	May 2016	
Class I Laser Product Complies with EN60825-1:2014, EN ISO 13849-1:2015 Class II Laser Product Complies with CDRH Made in Taiwan 4F-1., No.236, Fude 2nd Rd., Xizhi Dist., New Taipei City 22151, Taiwan		
  		

		Serial Number <b>Q53444</b>
Manufacturer	Great Computer Corporation	
Product	Laser Engraver	
Model	Spirit GLS Hybrid	
ModelNumber	GLS Hybrid-100TiF/20RMZ	
Wavelength	10.57~10.63 μm and 1064 nm	
Power	CO <sub>2</sub> 100W/Fiber 20W	
Input	200-240VAC, 50-60Hz, Max 15A	
Manufactured	May 2016	
Class I Laser Product Complies with EN60825-1:2014 Class IIIR Laser Product Complies with CDRH Made in Taiwan 4F-1., No.236, Fude 2nd Rd., Xizhi Dist., New Taipei City 22151, Taiwan		
  		



		Serial Number <b>Q53444</b>
Manufacturer	Great Computer Corporation	
Product	Laser Engraver	
Model	Spirit GLS Hybrid	
ModelNumber	GLS Hybrid-100TiF/30RMZ	
Wavelength	10.57~10.63 μm and 1064 nm	
Power	CO <sub>2</sub> 100W/Fiber 30W	
Input	200-240VAC, 50-60Hz, Max 15A	
Manufactured	May 2016	
Class I Laser Product Complies with EN60825-1:2014 Class IIIR Laser Product Complies with CDRH Made in Taiwan 4F-1., No.236, Fude 2nd Rd., Xizhi Dist., New Taipei City 22151, Taiwan		
  		

**GCC**  
*LaserPro*

Serial Number  
**Q53444**

Manufacturer	Great Computer Corporation
Product	Laser Engraver
Model	Spirit GLS Hybrid
ModelNumber	GLS Hybrid-100TiF/50RMZ
Wavelength	10.57~10.63 μm and 1064 nm
Power	CO <sub>2</sub> 100W/Fiber 50W
Input	200-240VAC, 50-60Hz, Max 15A
Manufactured	May 2016

Class I Laser Product Complies with EN60825-1:2014  
Class IIIR Laser Product Complies with CDRH  
Made in Taiwan  
4F-1., No.236, Fude 2nd Rd., Xizhi Dist., New Taipei City 22151, Taiwan

**GCC**  
*LaserPro*

Serial Number  
**Q53444**

Manufacturer	Great Computer Corporation
Product	Laser Engraver
Model	Spirit GLS Hybrid
ModelNumber	GLS Hybrid-100TiF/20JFL
Wavelength	10.57~10.63 μm and 1064 nm
Power	CO <sub>2</sub> 100W/Fiber 20W
Input	200-240VAC, 50-60Hz, Max 15A
Manufactured	May 2016

Class I Laser Product Complies with EN60825-1:2014, EN ISO 13849-1:2015  
Class II Laser Product Complies with CDRH  
Made in Taiwan  
4F-1., No.236, Fude 2nd Rd., Xizhi Dist., New Taipei City 22151, Taiwan

**GCC**  
*LaserPro*

Serial Number  
**Q53444**

Manufacturer	Great Computer Corporation
Product	Laser Engraver
Model	Spirit GLS Hybrid
ModelNumber	GLS Hybrid-100TiF/30JFL
Wavelength	10.57~10.63 μm and 1064 nm
Power	CO <sub>2</sub> 100W/Fiber 30W
Input	200-240VAC, 50-60Hz, Max 15A
Manufactured	May 2016

Class I Laser Product Complies with EN60825-1:2014, EN ISO 13849-1:2015  
Class II Laser Product Complies with CDRH  
Made in Taiwan  
4F-1., No.236, Fude 2nd Rd., Xizhi Dist., New Taipei City 22151, Taiwan

		Serial Number <b>Q53444</b>
Manufacturer	Great Computer Corporation	
Product	Laser Engraver	
Model	Spirit GLS Hybrid	
ModelNumber	GLS Hybrid-100TIF/60JFL	
Wavelength	10.57~10.63 μm and 1064 nm	
Power	CO <sub>2</sub> 100W/Fiber 60W	
Input	200-240VAC, 50-60Hz, Max 15A	
Manufactured	May 2016	
Class I Laser Product Complies with EN60825-1:2014, EN ISO 13849-1:2015 Class II Laser Product Complies with CDRH Made in Taiwan 4F-1., No.236, Fude 2nd Rd., Xizhi Dist., New Taipei City 22151, Taiwan		
  		

		Serial Number <b>Q53444</b>
Manufacturer	Great Computer Corporation	
Product	Laser Engraver	
Model	Spirit GLS Hybrid	
ModelNumber	GLS Hybrid-100GT/20JFL	
Wavelength	10.57~10.63 μm and 1064 nm	
Power	CO <sub>2</sub> 100W/Fiber 20W	
Input	200-240VAC, 50-60Hz, Max 15A	
Manufactured	May 2016	
Class I Laser Product Complies with EN60825-1:2014, EN ISO 13849-1:2015 Class II Laser Product Complies with CDRH Made in Taiwan 4F-1., No.236, Fude 2nd Rd., Xizhi Dist., New Taipei City 22151, Taiwan		
  		

		Serial Number <b>Q53444</b>
Manufacturer	Great Computer Corporation	
Product	Laser Engraver	
Model	Spirit GLS Hybrid	
ModelNumber	GLS Hybrid-100GT/20RMZ	
Wavelength	10.57~10.63 μm and 1064 nm	
Power	CO <sub>2</sub> 100W/Fiber 20W	
Input	200-240VAC, 50-60Hz, Max 15A	
Manufactured	May 2016	
Class I Laser Product Complies with EN60825-1:2014, EN ISO 13849-1:2015 Class II Laser Product Complies with CDRH Made in Taiwan 4F-1., No.236, Fude 2nd Rd., Xizhi Dist., New Taipei City 22151, Taiwan		
  		



		Serial Number <b>Q53444</b>
Manufacturer	Great Computer Corporation	
Product	Laser Engraver	
Model	Spirit GLS Hybrid	
Model Number	GLS Hybrid-100GT/30RMZ	
Wavelength	10.57~10.63 μm and 1064 nm	
Power	CO <sub>2</sub> 100W/Fiber 30W	
Input	200-240VAC, 50-60Hz, Max 15A	
Manufactured	May 2016	
Class I Laser Product Complies with EN60825-1:2014, EN ISO 13849-1:2015 Class II Laser Product Complies with CDRH Made in Taiwan 4F-1., No.236, Fude 2nd Rd., Xizhi Dist., New Taipei City 22151, Taiwan		
  		

		Serial Number <b>Q53444</b>
Manufacturer	Great Computer Corporation	
Product	Laser Engraver	
Model	Spirit GLS Hybrid	
Model Number	GLS Hybrid-100GT/50RMZ	
Wavelength	10.57~10.63 μm and 1064 nm	
Power	CO <sub>2</sub> 100W/Fiber 50W	
Input	200-240VAC, 50-60Hz, Max 15A	
Manufactured	May 2016	
Class I Laser Product Complies with EN60825-1:2014, EN ISO 13849-1:2015 Class II Laser Product Complies with CDRH Made in Taiwan 4F-1., No.236, Fude 2nd Rd., Xizhi Dist., New Taipei City 22151, Taiwan		
  		

		Serial Number <b>Q53444</b>
Manufacturer	Great Computer Corporation	
Product	Laser Engraver	
Model	Spirit GLS Hybrid	
Model Number	GLS Hybrid-100GT/30JFL	
Wavelength	10.57~10.63 μm and 1064 nm	
Power	CO <sub>2</sub> 100W/Fiber 30W	
Input	200-240VAC, 50-60Hz, Max 15A	
Manufactured	May 2016	
Class I Laser Product Complies with EN60825-1:2014, EN ISO 13849-1:2015 Class II Laser Product Complies with CDRH Made in Taiwan 4F-1., No.236, Fude 2nd Rd., Xizhi Dist., New Taipei City 22151, Taiwan		
  		

		Serial Number <b>Q53444</b>
Manufacturer	Great Computer Corporation	
Product	Laser Engraver	
Model	Spirit GLS Hybrid	
ModelNumber	GLS Hybrid-100GT/30JFL	
Wavelength	10.57~10.63 μm and 1064 nm	
Power	CO <sub>2</sub> 100W/Fiber 30W	
Input	200-240VAC, 50-60Hz, Max 15A	
Manufactured	May 2016	
Class I Laser Product Complies with EN60825-1:2014, EN ISO 13849-1:2015 Class II Laser Product Complies with CDRH Made in Taiwan 4F-1., No.236, Fude 2nd Rd., Xizhi Dist., New Taipei City 22151, Taiwan		
		

		Serial Number <b>Q53444</b>
Manufacturer	Great Computer Corporation	
Product	Laser Engraver	
Model	Spirit GLS Hybrid	
ModelNumber	GLS Hybrid-100GT/60JFL	
Wavelength	10.57~10.63 μm and 1064 nm	
Power	CO <sub>2</sub> 100W/Fiber 20W	
Input	200-240VAC, 50-60Hz, Max 15A	
Manufactured	May 2016	
Class I Laser Product Complies with EN60825-1:2014, EN ISO 13849-1:2015 Class II Laser Product Complies with CDRH Made in Taiwan 4F-1., No.236, Fude 2nd Rd., Xizhi Dist., New Taipei City 22151, Taiwan		
		

### CDRH Label

This label indicates the class level of CDRH.

For CO<sub>2</sub> laser models: Spirit, Spirit LS, and Spirit GLS



For Spirit GLS Hybrid with below model No.:

GLS Hybrid-30V/20RMZ, GLS Hybrid-30V/30RMZ, GLS Hybrid-30V/50RMZ, GLS Hybrid-40V/20RMZ, GLS Hybrid-40V/30RMZ, GLS Hybrid-40V/50RMZ, GLS Hybrid-60Ti/20RMZ, GLS Hybrid-60Ti/30RMZ,

GLS Hybrid-60Ti/50RMZ, GLS Hybrid-80Ti/20RMZ, GLS Hybrid-80Ti/30RMZ, GLS Hybrid-80Ti/50RMZ, GLS Hybrid-100TiF/20RMZ, GLS Hybrid-100TiF/30RMZ, GLS Hybrid-100TiF/50RMZ

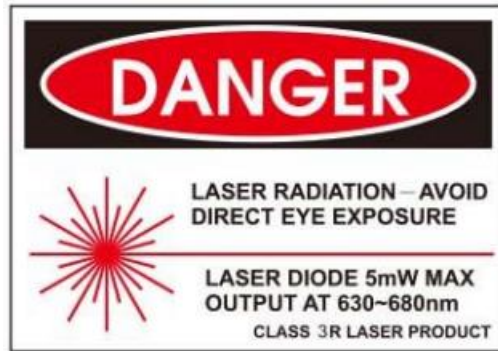

### CE Label

This label indicates the class level of CE

For CO2 laser models: Spirit, Spirit LS, and Spirit GLS.



For Spirit GLS Hybrid with below model No.:

GLS Hybrid-30V/20RMZ, GLS Hybrid-30V/30RMZ, GLS Hybrid-30V/50RMZ, GLS Hybrid-40V/20RMZ, GLS Hybrid-40V/30RMZ, GLS Hybrid-40V/50RMZ, GLS Hybrid-60Ti/20RMZ, GLS Hybrid-60Ti/30RMZ, GLS Hybrid-60Ti/50RMZ, GLS Hybrid-80Ti/20RMZ, GLS Hybrid-80Ti/30RMZ, GLS Hybrid-80Ti/50RMZ, GLS Hybrid-100TiF/20RMZ, GLS Hybrid-100TiF/30RMZ, GLS Hybrid-100TiF/50RMZ



### Laser Path Warning Label

LaserPro machines are very safe under normal functioning conditions. However, in case of any accident,

Laser Path Warning Label will be affixed on the possible laser path. When operators are nearby these paths, they should be careful of the possible injury while the machine is operating.



### Warning Label

Warning Label is written with all the necessary information to be aware of in every operation.

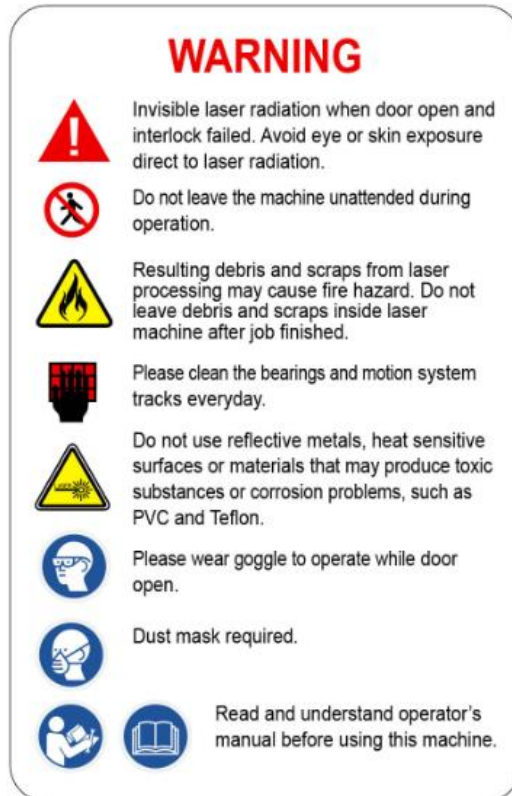

### Laser Path Danger label

This label indicates the laser path. Normally you can find this label inside of machine. Please take extra caution of this area when you conduct maintenance.

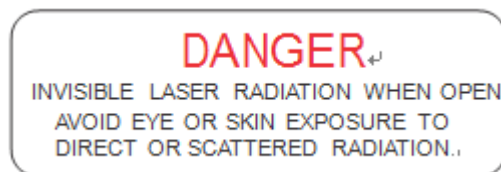

### Emergency Stop Label

This label indicates the emergency stop button. You can find this label on the right upper side of the machine.



### Aperture warning stickers (mirror):

This label indicates the laser path. Normally you can find this label inside of machine or laser exit. Please take extra caution of this area when you conduct maintenance or operate machine.



### Door open warning labels



### Warning Label

This label is located on the laser outer case of 60W/80W/100W only

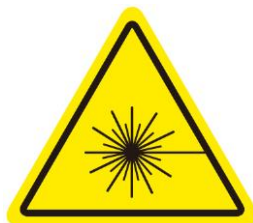

## Protection Window Label

This label indicates the protection wavelength. You can find this label in the lower right corner of window.

For CO2 laser models: Spirit, Spirit LS, and Spirit GLS.

**OD7+ @ 10,600 nm  
Protection Window**

For Spirit GLS Hybrid with below model No.:

GLS Hybrid-30V/20RMZ, GLS Hybrid-30V/30RMZ, GLS Hybrid-30V/50RMZ, GLS Hybrid-40V/20RMZ, GLS Hybrid-40V/30RMZ, GLS Hybrid-40V/50RMZ, GLS Hybrid-60Ti/20RMZ, GLS Hybrid-60Ti/30RMZ, GLS Hybrid-60Ti/50RMZ, GLS Hybrid-80Ti/20RMZ, GLS Hybrid-80Ti/30RMZ, GLS Hybrid-80Ti/50RMZ, GLS Hybrid-100TiF/20RMZ, GLS Hybrid-100TiF/30RMZ, GLS Hybrid-100TiF/50RMZ

**OD6+ @ 1064 nm Protection Window**

**OD5+ @ 10,600 nm  
Protection Window**

### NOTE

SmartGUARD™ is an optional fire detection alarm system developed by GCC. Contact your local GCC authorized distributor for more details to have this safety option installed onto your system.

## 1.5 Safety Measures

### 1.5.1 General Safety

- **LASER RADIATION WARNING:** Exposure to laser radiation may result in physical burns and severe eye damage. Proper use and regular maintenance of this machine is important to the safety of all people in the immediate area.
- Prior to operation, carefully read and familiarize yourself with the warning labels located on both your laser system and in this manual.
- Never leave the machine unattended during the laser cutting and engraving process. The laser may ignite combustible materials. A well-maintained fire extinguisher and operational smoke or fire detector should be kept in the vicinity of the machine.
- Caution—Use of controls or adjustments or performance of procedures other than those specified herein may result in hazardous radiation exposure.
- Resulting debris from laser cutting are very dangerous and may cause fire hazard.
- **DO NOT** leave debris and scraps inside laser machine after job finished. Always keep machine clean after job finished.

#### **NOTE**

Each Spirit, Spirit LS, and Spirit GLS is shipped with a single pair of safety goggles. If additional safety goggles are required, please contact GCC directly or an authorized GCC distributor. If you wish to purchase one on your own, please make sure the safety goggles meet these requirements:

**9000-11000nm OD5+**  
**Visible Light Transmission: 92.9%**

#### **NOTE**

Each Spirit GLS Hybrid with dual lasers installed, the machine is shipped with a single pair of safety goggles. If additional safety goggles are required, please contact GCC directly or an authorized GCC distributor. If you wish to purchase one on your own, please make sure the safety goggles meet these requirements:

**190 - 534 nm OD5+**  
**910-1070 nm OD6+**  
**Visible Light Transmission: 23.5%**



## WARNING

- Resulting debris from laser processing are very dangerous and may cause fire hazard
- **DO NOT** leave debris and scraps inside laser machine after job finished. Must keep machine clean after job finished.
- Always remove the vector grid to clean any small pieces that have fallen through the grid.

- Enable the SmartAIR™ nozzle when engraving or cutting materials that may easily ignite, such as acrylic, wood, or paper.
- Always wear safety goggles when the laser system is in operation. Reflective materials such as mirrors, enameled brass and anodized aluminum may partially-reflect some of the invisible laser radiation. Severe eye damage may occur if proper safety goggles are not worn.
- Connect the machine to a properly grounded power outlet. Ensure the voltage of the power source is identical to the voltage of the machine.
- Do not open the laser access panel when the machine is plugged in.
- Do not attempt to modify or disassemble the laser module.
- Do not attempt to remove or modify any component of the machine's laser interlock safety system.
- Ensure the immediate work area of the machine is well-ventilated. Odors, vapors, and dust are by products generated during the laser engraving and cutting process. An exhaust system, vacuum cutting box, and honeycomb table are recommended. Please contact GCC or your local GCC distributor for more information.
- Do not laser heat-sensitive surfaces or materials that may generate toxic fumes, such as PVC and Teflon.
- Regularly clean and maintain your machine according to our cleaning and maintenance Instructions in Chapter 8. Doing so will ensure your machine will operate effectively and safely over a long period of time.

### 1.5.2 Safety Notice for Class 4 Machine

When the optional Pass-Through door module is installed, the laser system becomes a Class 4 machine with front and rear doors open, machine operators must wear goggles and follow the safety instructions to operate the machine.

Exposure to a Class 4 laser beam via direct radiation and indirect stray radiation may cause damage to both skin and eyes. Exposure to the Class 4 laser beam may cause ignition of combustible materials which can lead to a fire. A proper and well-maintained fire extinguisher should keep on



hand next to the laser machine all the times.

The machine operator is responsible to take all necessary protective measures to prevent the possible ignition or explosion of materials by the laser beam. A Class 4 laser system should be operated according to the following precautionary measures among others:

- The operator is obliged to appoint a **trained Laser Protection Officer** responsible for compliance with the relevant regulations.
- **Identify the danger zone** by installing **warning lights** and **warning signs** outside the area.
- **The danger zone must be secured against unauthorized access.**
- The operator of a Class 4 laser system should always **wear laser protection goggles** suitable for the laser wavelength in use and with optical density at least OD5+ within the danger zone.
- An additional warning light should also be installed in a visible location to warn the machine operator of any emerging laser radiation.

## 1.6 Operating Environment

Please follow the guidelines when considering a suitable location to set the LaserPro Spirit Series. Improper work environments may lead to operational malfunction and/or unsafe working conditions. The LaserPro Spirit Series should be placed and operated in a standard office-type environment.

- Avoid environments where the machine is exposed to high levels of dust, temperature (temperature exceeding 30°C or 85°F) or humidity (humidity exceeding 70% or where the ambient temperature is near the dew point).
- Avoid small, enclosed areas with poor ventilation.
- Avoid areas with high levels of noise and electrical noise.
- Select a location that is large enough to accommodate the LaserPro Spirit Series, an exhaust system, a computer and a work or storage table.
- Select a location in which the ambient temperature remains between 15°C and 30°C (60°F to 85°F).
- Select a location in which the relative humidity remains between 30% - 40%.
- Select a location in which there is a short, direct path to the fume exhaust system.
- Set the LaserPro Spirit Series on a floor surface that is completely even.
- Make sure your smoke or fire detection system in the immediate area is functioning.
- Setup the machine to be apart from the wall for at least 60 cm (2 feet).

## 1.7 Noise Test

Test Conditions: measured at a distance of 1 meter from the surface of the machinery and a height of 1.6 meters from the floor or access platform.

- Spirit, Spirit LS, Spirit GLS 40W Sound Test Result: 49.8 dB
- Spirit GLS 100W Sound Test Result: 70.2 dB

## 1.8 EC-Declaration of Conformity

### ***EC DECLARATION OF CONFORMITY***

Applicant : Great Computer Corp.

Address of Applicant : 4F-1., No.236, Fude 2nd Rd., Xizhi Dist., New Taipei City  
22151, Taiwan

Product Name : GCC LaserPro Spirit Series Laser Engraver

Model No. : SI #-XXXXXX, SLS #-XXXXXX, GLS #-XXXXXX, GLS  
Hybrid-XXXXXX/YYYYYY (# = none character, blank, II, III,  
IV ... X, or A-Z; XXXXXX & YYYYYY = laser supplier tube  
model or blank)

Directive : 2006/42/EC Machinery Directive  
2014/35/EU Low Voltage Directive  
2014/30/EU Electromagnetic Compatibility Directive

For the most specific risks of this machine, safety and compliance with the essential requirements of the Directive has been based on elements of:

- EN ISO 12100:2010 / Safety of machinery — General principles for design — Risk assessment and risk reduction
- EN ISO 11553-1:2008 / Safety of machinery - Laser processing machines - Part 1: General safety requirements
- EN 60825-1:2014 / Safety of laser products -- Part 1: Equipment classification and requirements
- EN 60204-1:2006+A1:2009+AC: 2010 / Safety of machinery - Electrical equipment of machines- Part 1 : General requirements- Industrial electrical device
- EN 61000-6-2:2005 / Electromagnetic compatibility (EMC) -- Part 6-2: Generic standards - Immunity for industrial environments
- EN 61000-6-4:2007/A1:2011 / Electromagnetic compatibility (EMC) -- Part 6-4: Generic standards - Emission standard for industrial environment



# 2

Chapter 2

---

## Unpacking & Contents

Unloading and Unpacking

How to packing properly

Contents and Accessories Checklist

## 2.1 Unloading and Unpacking

The LaserPro Spirit Series is shipped in one crate that contains the machine, the software, and all of the necessary accessories. The following section shows detailed step-by-step instructions for unpacking and assembly of the machine.

### WARNING

More than one person may be needed when loading and unloading the shipping crate in order to avoid body injury or damage to the machine

### NOTE

Please store the original shipping crate as it may be needed for transportation in the future



GCC has used eco-friendly metal crates for GCC LaserPro laser engravers including Spirit Series and S290LS. Other models will change to metal packing crate in the near future.

For years, GCC LaserPro has been dedicated to reducing carbon footprint and becoming a greener company in the industry.

## Installation location

Before unpacking the laser system, make sure the location in which you intend to install the laser system will provide at least **2 feet (0.6meter)** of clearance on all sides of the machine.

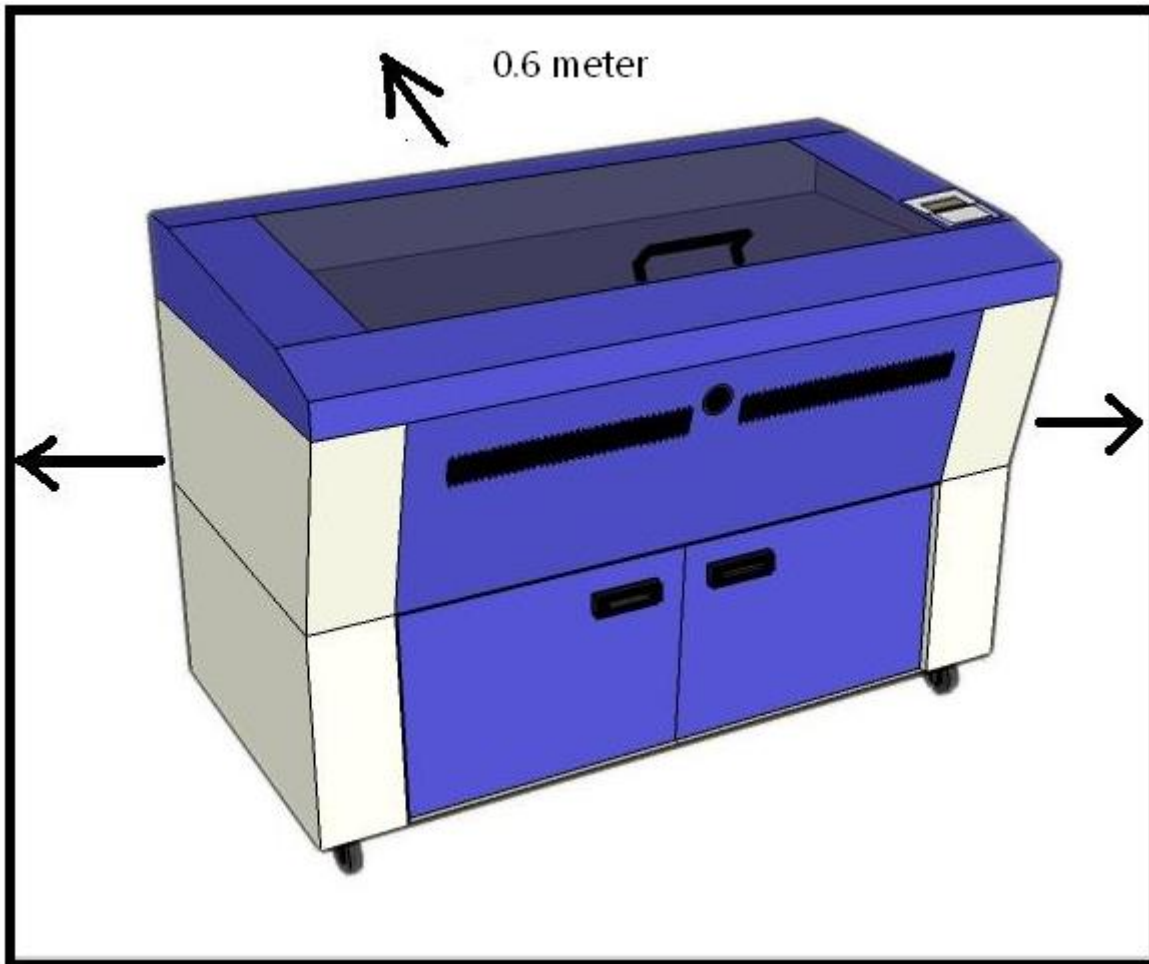

## Unpacking and Unloading

Move the shipping crate close to the desired working location of the machine. Unpack following the steps below.



Step 1: Remove the 6 metal clips that secures the top panel to the crate by using a flathead screwdriver

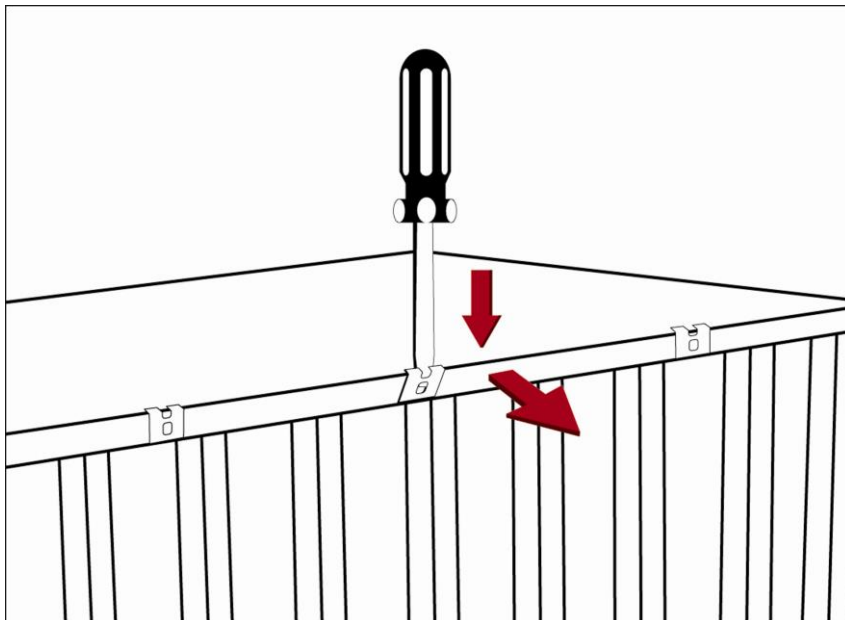

Step 2: Lift the top panel and remove



Step 3: Use a flathead screwdriver to remove the brackets that secures the bars in place.

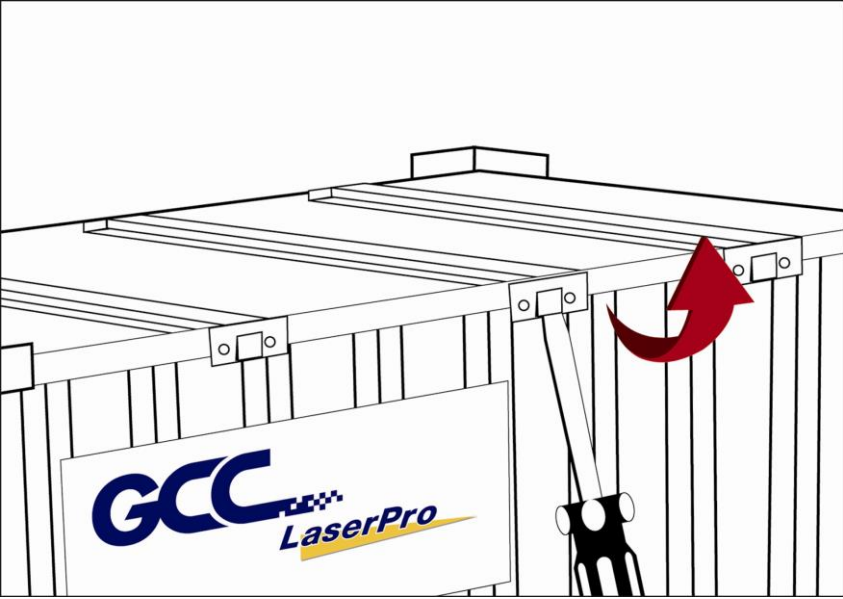

Step 4: Remove the top bars.

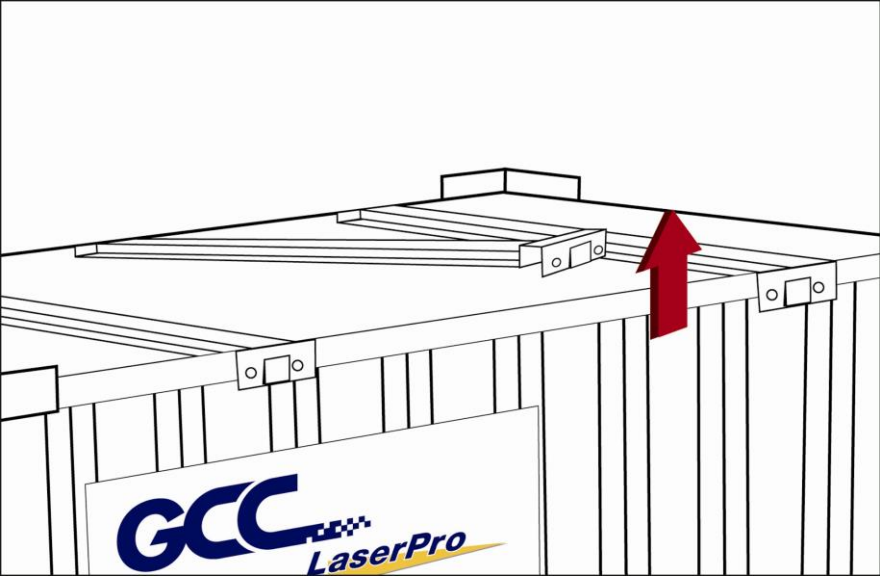

Step 5: Use a flathead screwdriver to pry loose the side brackets and remove them.

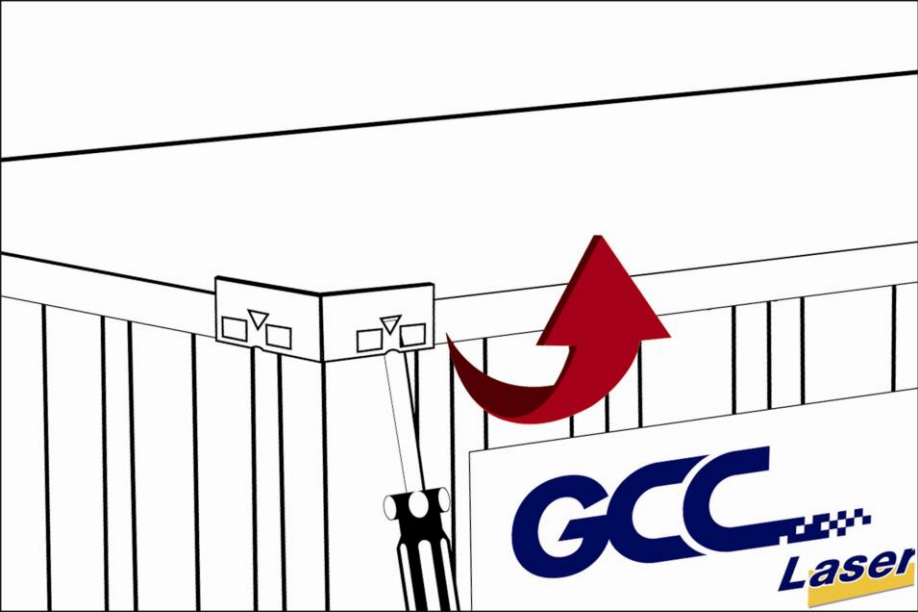



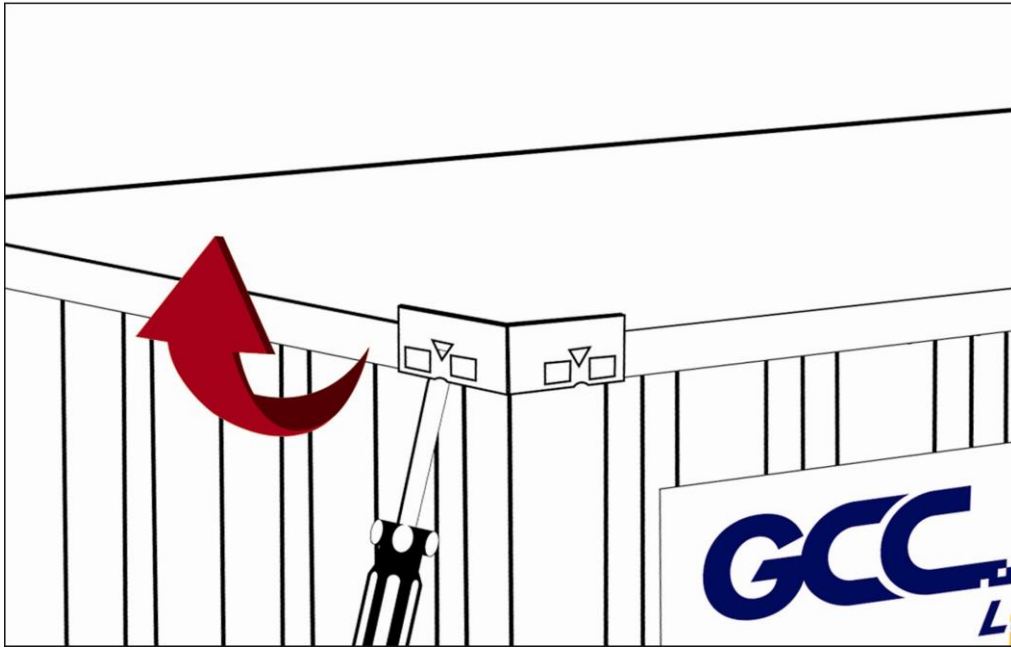

Step 6: Pull the front panel and lower it to an angle of about 45 degrees and then pull it away from the crate. Do the same for the rear panel.

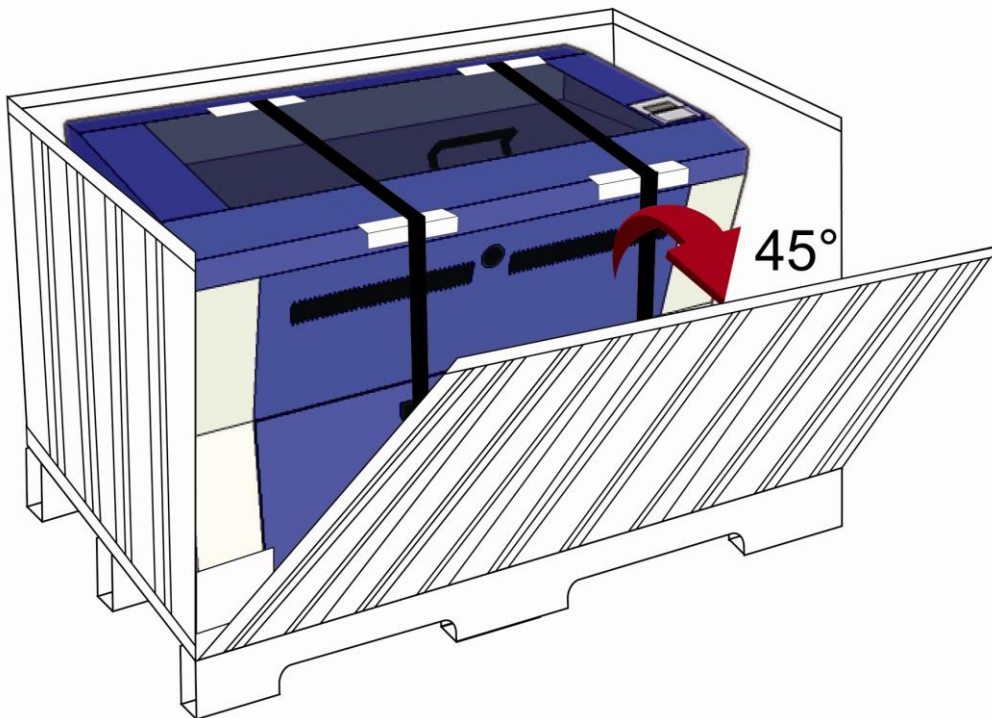

Step 7: Remove the left and right panels in the same way after the front and rear panels have been removed

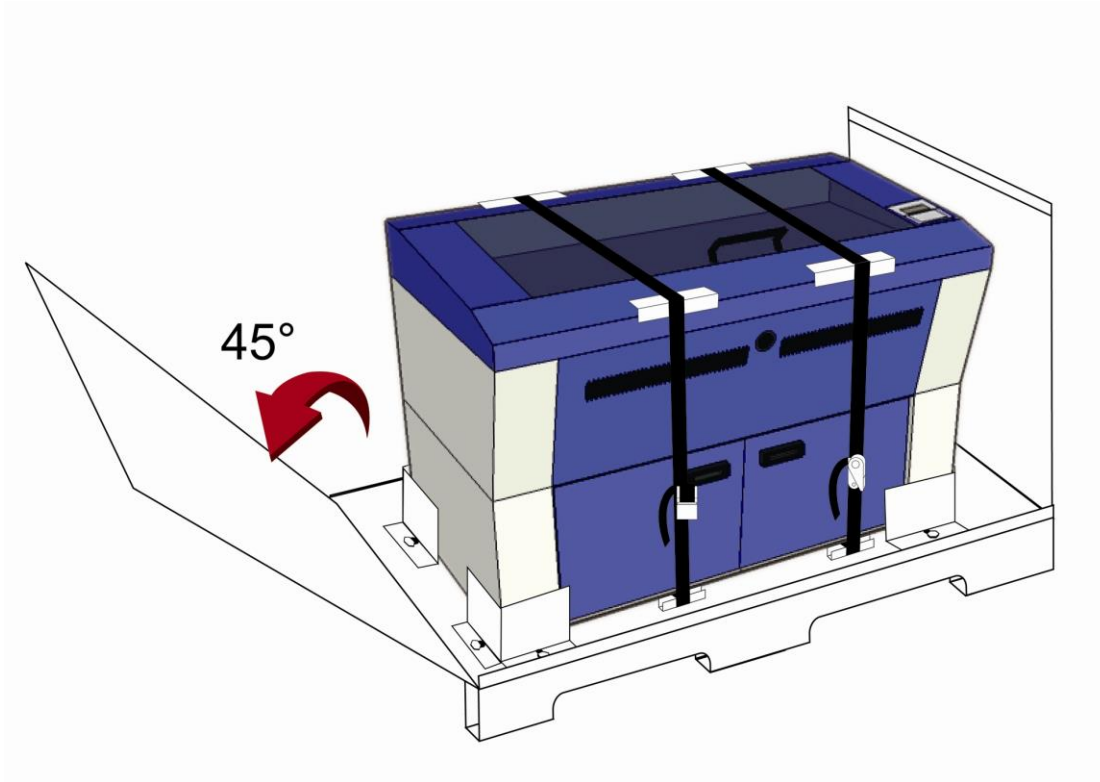

Step 8: Unbuckle and remove the belts that holds the machine in place.

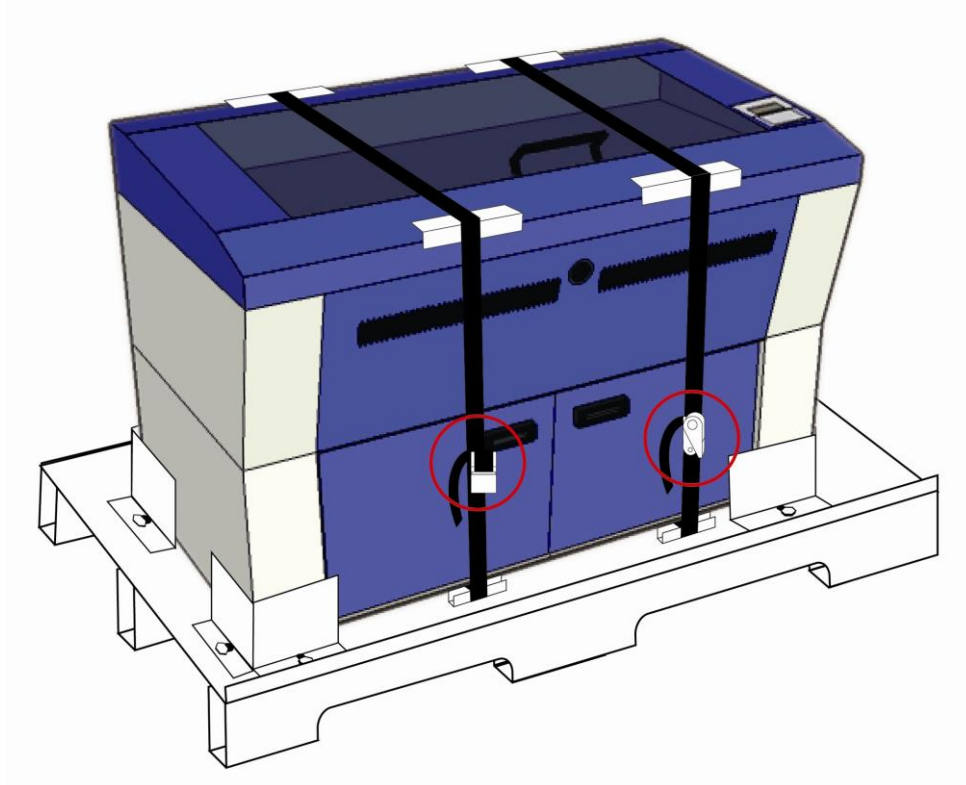

Step 9: Use a Philips screwdriver to remove the brackets that holds the machine in place

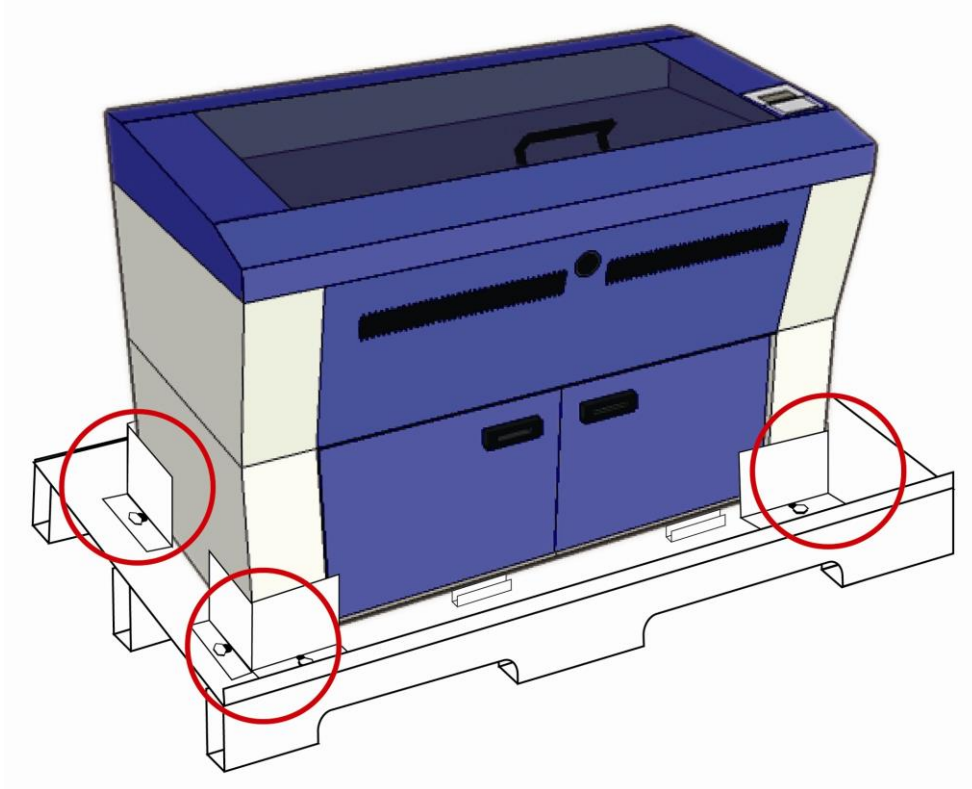

Step 10: Position the ramps as shown below and the machine can now be pushed off the base board via the ramps. (The ramps are found in a box within the crate)

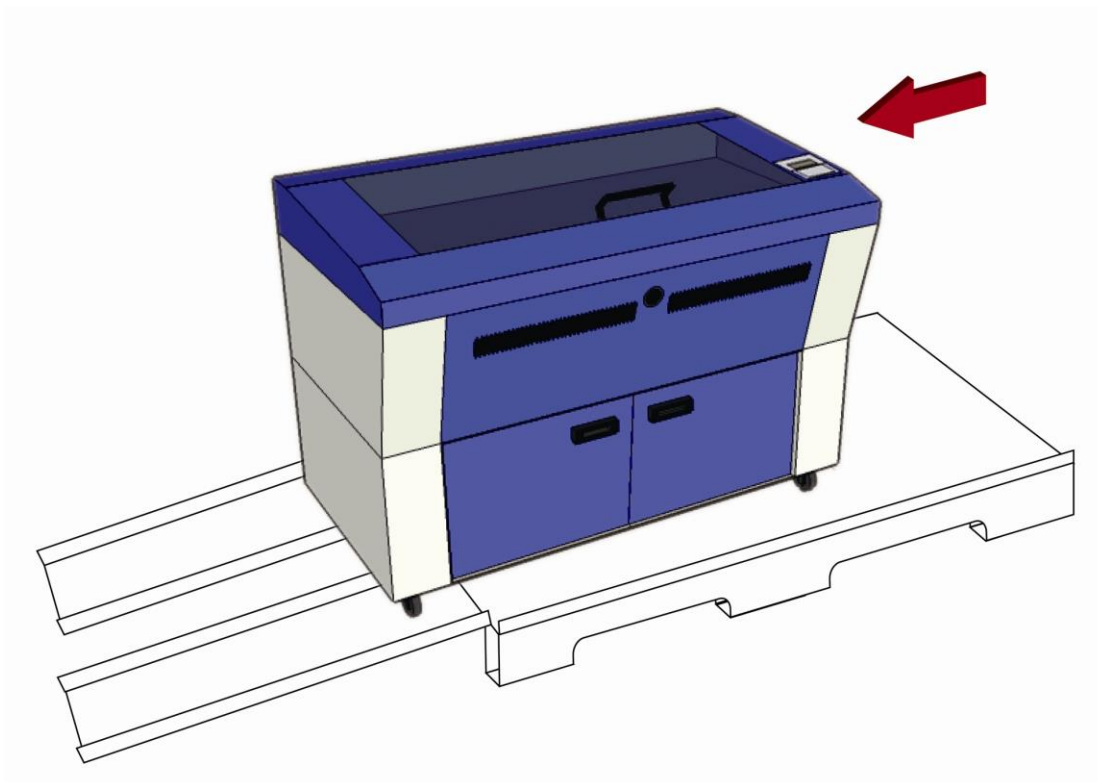

## 2.2 How to Re-pack the Machine

Step 1: Set up the ramp with the base board and carefully push the machine onto the iron pallet.

NOTE: More than one person may be needed when loading and unloading the shipping crate in order to avoid body injury or damage to the machine.

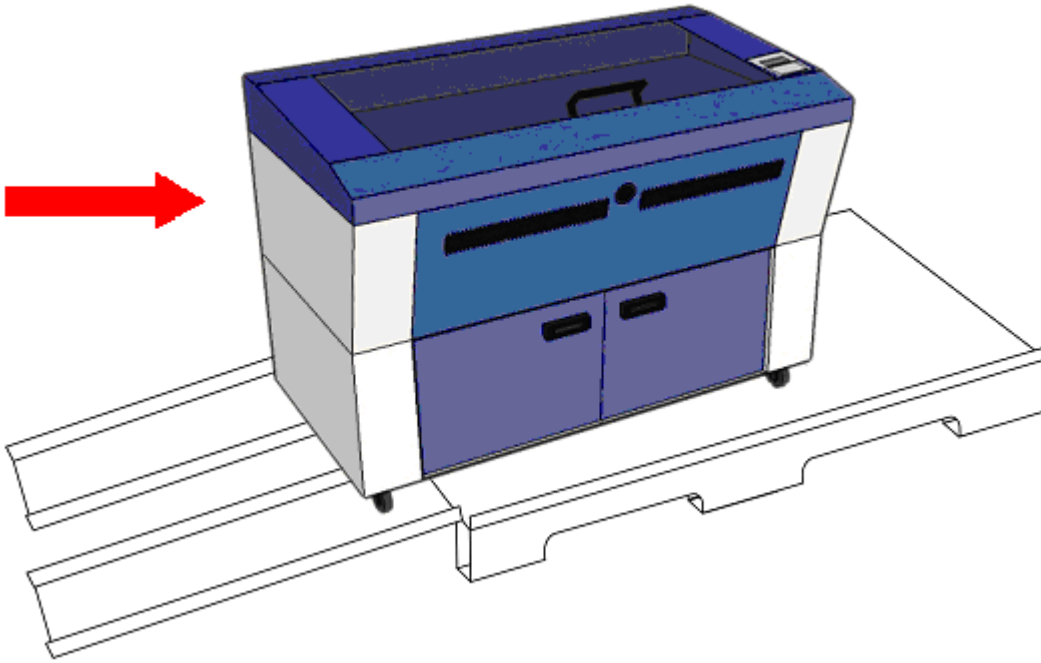

Step 2: Fasten the belts accordingly and make sure the machine is affixed on the iron plate.

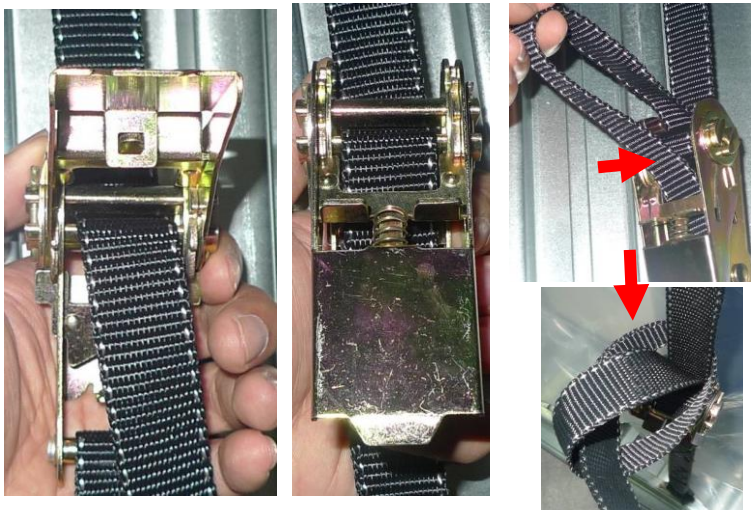



Step 3: Insert four side boards on the slot of bottom plate.



Step 4: Fix the four side boards by four corner brackets.



Step 5: Place the top cover on the top of the machine and fix it with the fixers.  
The machine is now repacked and ready for shipping.

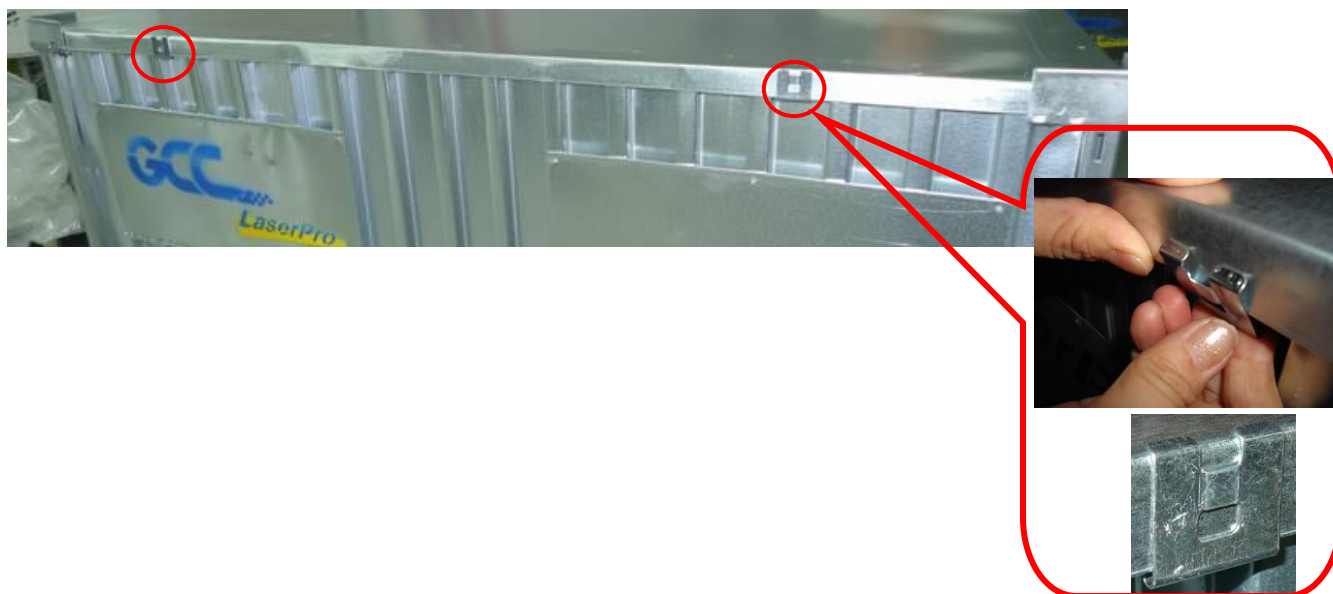

## 2.3 Contents and Accessories Checklist

Please check to make sure that all of the following items are included within the shipping crate. If any of the following items are missing, immediately contact your local GCC distributor.

ITEM		QUANTITY (pc/ set)
Cleaning Kit	Cotton swab	1
	Lens Cleaner Solution	1
	Lens Tissue	1
Main Power Cord		1
USB Cable		1
LAN Cable		1
Focusing Tool		1
Goggles		1
Exhaust Port Connector		1
Magnetic Bar for Ventilation Cover		2
Installation CD (user manual, driver)		1
Grease Syringe (for Spirit LS and Spirit GLS models)		1
Lubrication Grease		1
Quality Promise Card		1
Laser Firing Control Key		1
Spare Roller Set (for Spirit model only)		3

# 3

Chapter 3

---

## Mechanical Overview

Front View

Top View

Right View

Left View

Rear View



Please take some time to familiarize yourself with this section regarding the mechanical overview of the LaserPro Spirit Series. References will be made back to the different parts of the LaserPro Spirit Series in later sections.

### 3.1 Front View

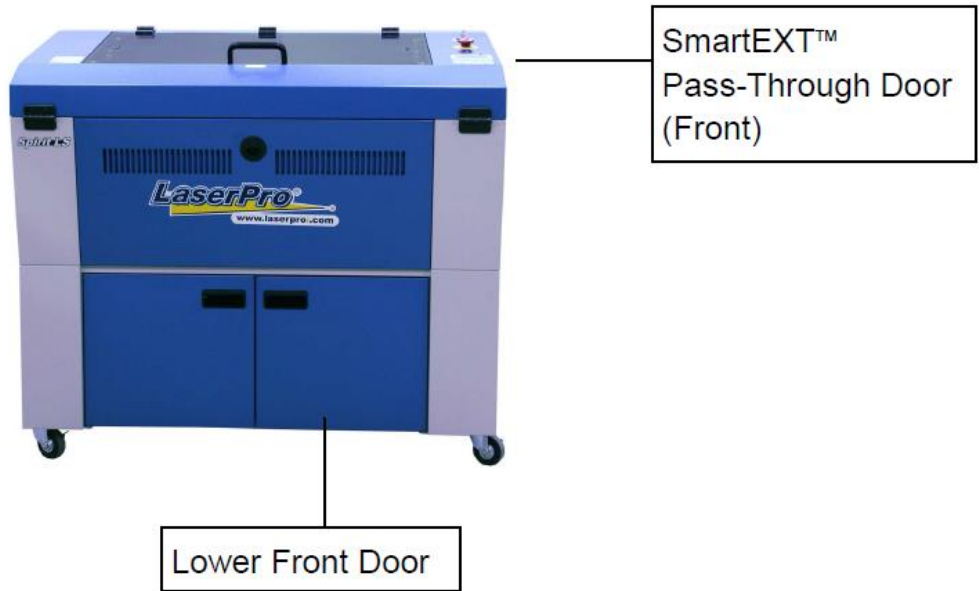

### 3.2 Top View

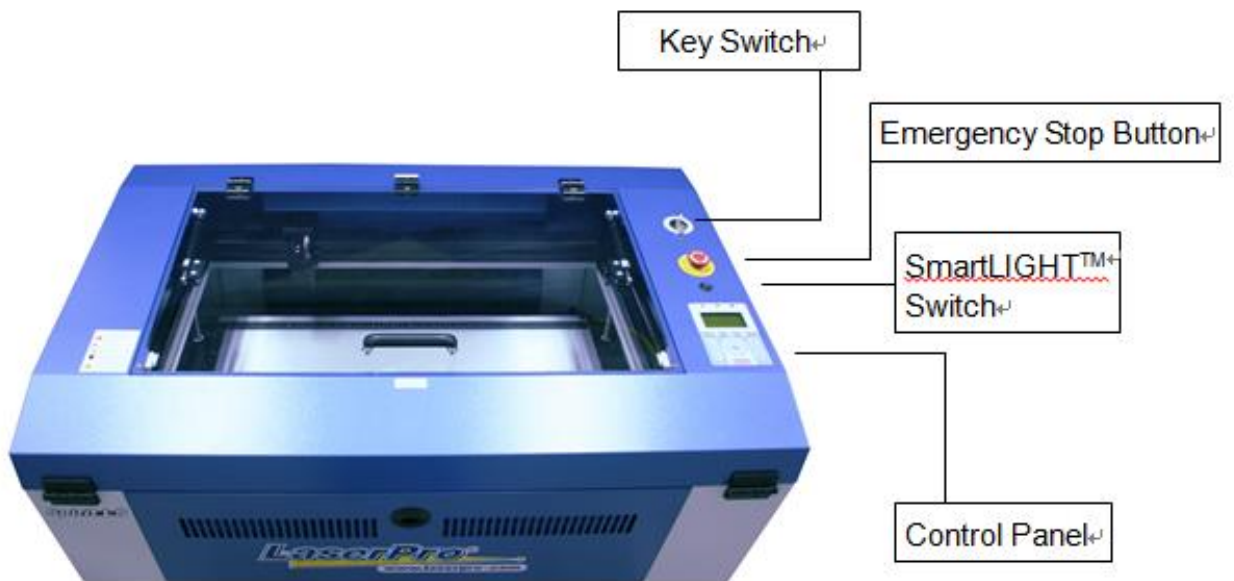

### 3.3 Right (Profile) View

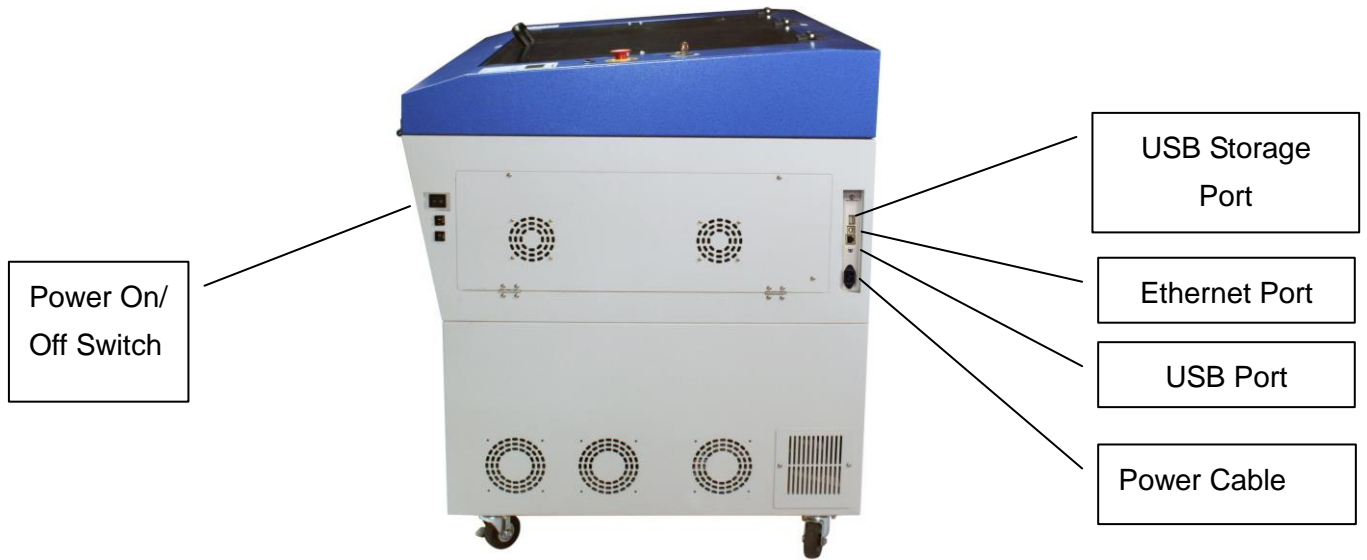

### 3.4 Left (Profile) View



3.5 Rear View

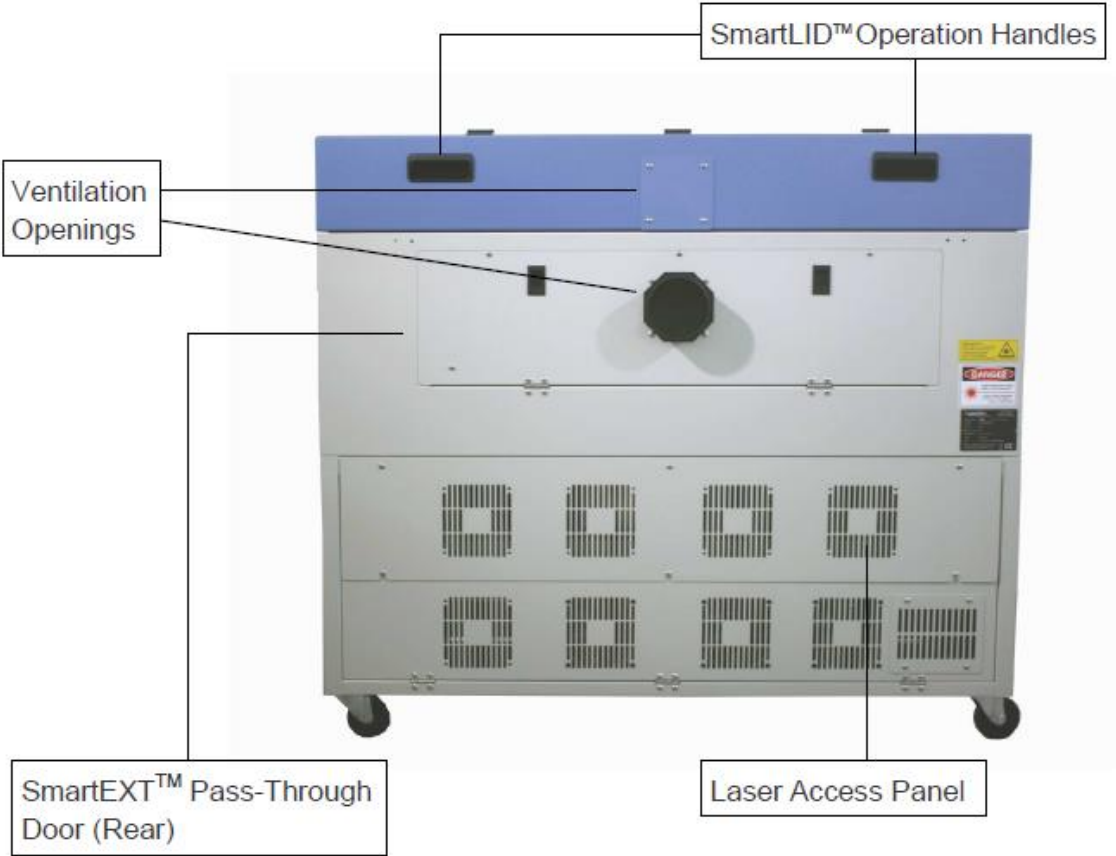

# 4

Chapter 4

---

## Setup and Installation

### Machine Setup

- Powering Up the Machine
- Power Cable Connection
- Connecting the Computer

### Graphics Software Setup

- Recommended Computer Configuration
- Installation of the LaserPro USB Driver
- Installation of the LaserPro Print Driver

## 4.1 Machine Setup

### 4.1.1 Powering Up the Machine



#### CAUTION

Make sure both the LaserPro Spirit Series and the computer are turned off before connecting either to a power source.

- 1) Connect the male end of the power cord to a quality surge protector and then connect the surge protector to a properly grounded outlet.
- 2) Do the same for the computer system.
- 3) Connect the air compressor and external air extraction system to the laser machine before powering up. The connection and setup of air compressor and air extraction system refer to Chapter 7 for details.
- 4) Connect the female end of the power cord into the machine's power cable inlet located on the right side of machine.

#### NOTE

- The LaserPro Spirit Series has been designed to automatically switch from 100-240 VAC.
- Make sure to supply 220 VAC of electricity to the LaserPro Spirit Series with laser 80Watt and above.

### 4.1.2 Connecting the Computer

The LaserPro Spirit Series can communicate with a computer through a USB Port or LAN Port connection interface. Regardless of the connection method chosen, you will need to connect the respective connection cable from the LaserPro Spirit Series to your computer.

**USB Connectivity:** Connect the included USB Cable to the USB Port on the right-hand side of the laser system.

**Ethernet Connectivity:** Connect the Ethernet Cable in accessory to the Ethernet port on the right-hand side of the laser system. Follow below instruction for Ethernet connectivity setup.

#### NOTE

1. Never leave laser system unattended during laser cutting, engraving, and marking process, even with Ethernet or Wi-Fi connection setup, this requirement cannot be avoided. Exposure to the laser beam may cause ignition flame to combustible materials.
2. DO NOT connect USB cable when using Ethernet function for data transmission.
3. If you have purchased additional Optional Accessories for the LaserPro Spirit Series, please refer to chapter VII for instructions on how to properly setup your optional accessories. These should be setup prior to working with your LaserPro Spirit Series.

### 4.1.2.1 Networking Connectivity Setup

GCC laser engraver is built-in with LAN port to enable multiple laser engravers to be operated by one PC and multiple PCs to share a single unit of laser engraver. Follow the setup instructions below.

Step 1. Connect LAN cable to the LAN port of GCC laser engravers and turn on machine

Step 2. Navigate the control panel through <F4> Function → <Machine Setting> → <LAN Setup Wizard> → IP Address.

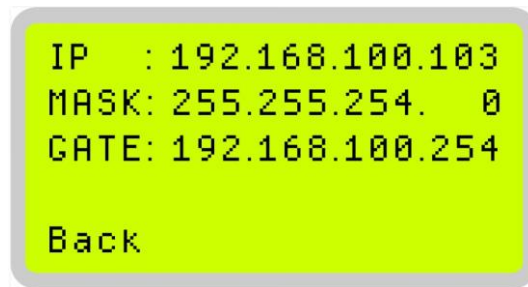

Step 3. Go to Windows <Control Panel> → <Hardware and Sound> → <Printer>, and right click on Spirit series printer to check printer properties.

Step 4. Go to <Ports> tab of Spirit series printer properties, and select <Add Port>, and follow the instruction to enter the TCP/IP information received from laser machine control panel in step 2.

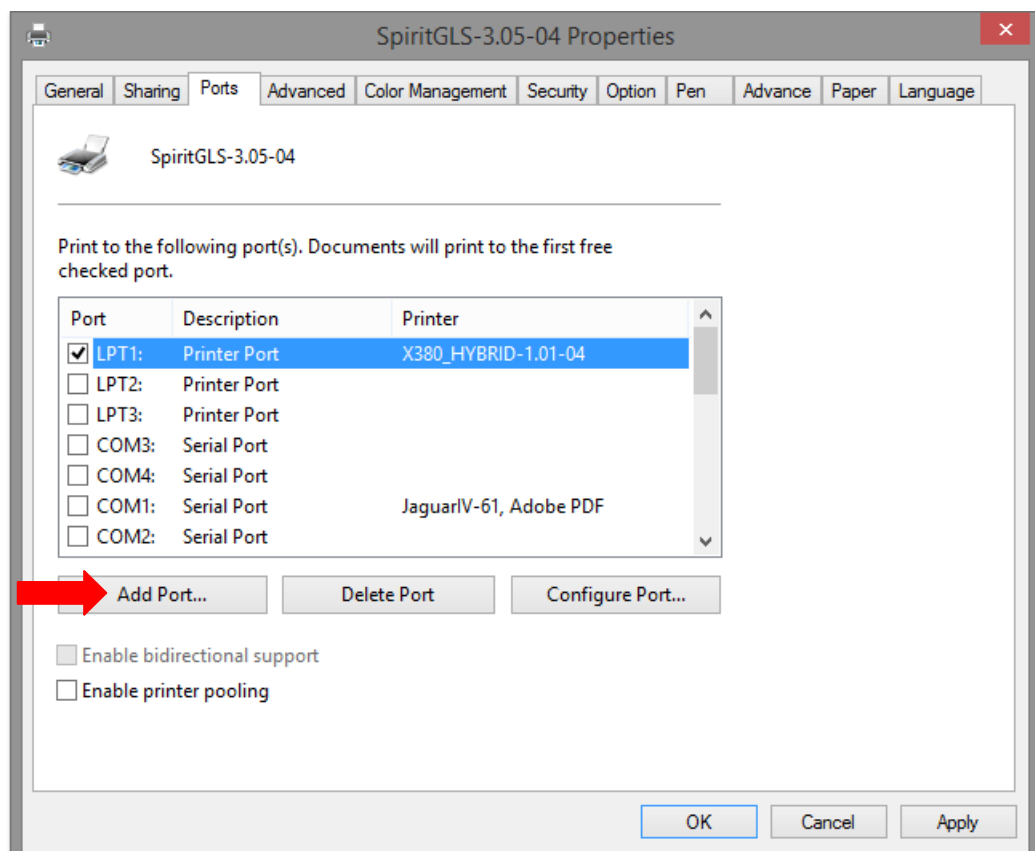

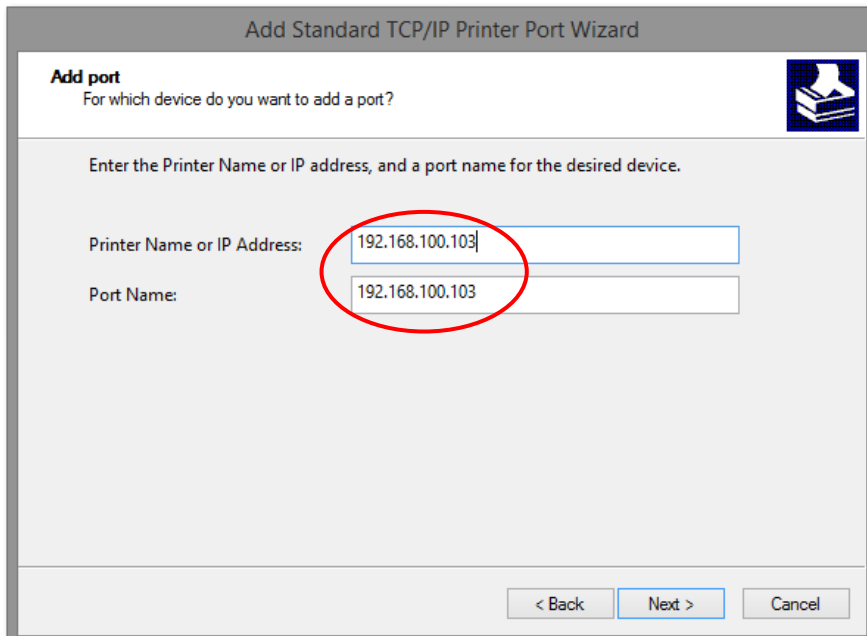
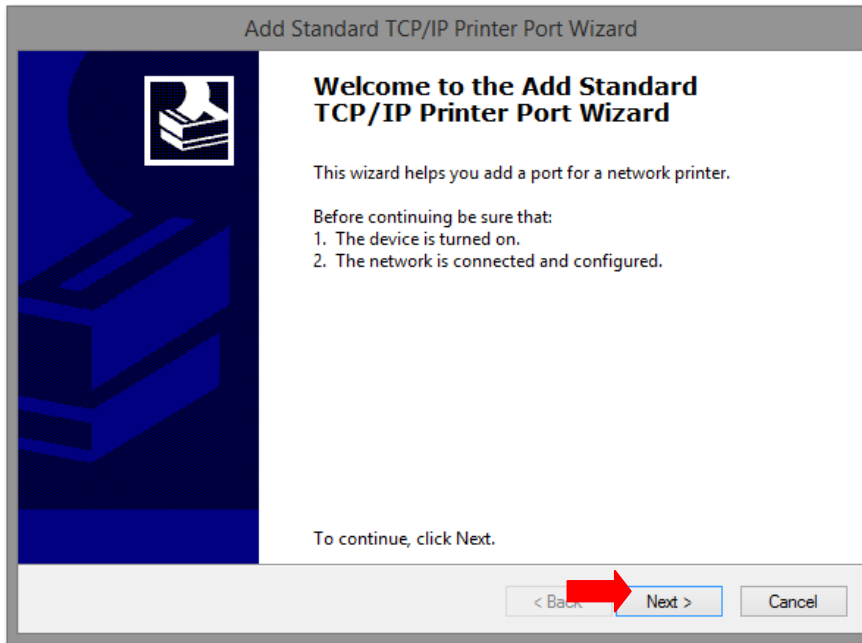
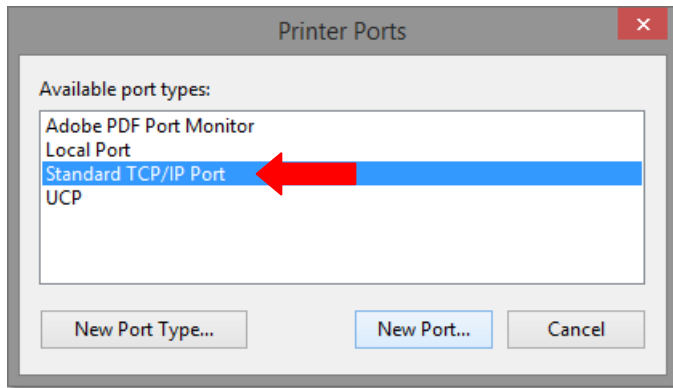

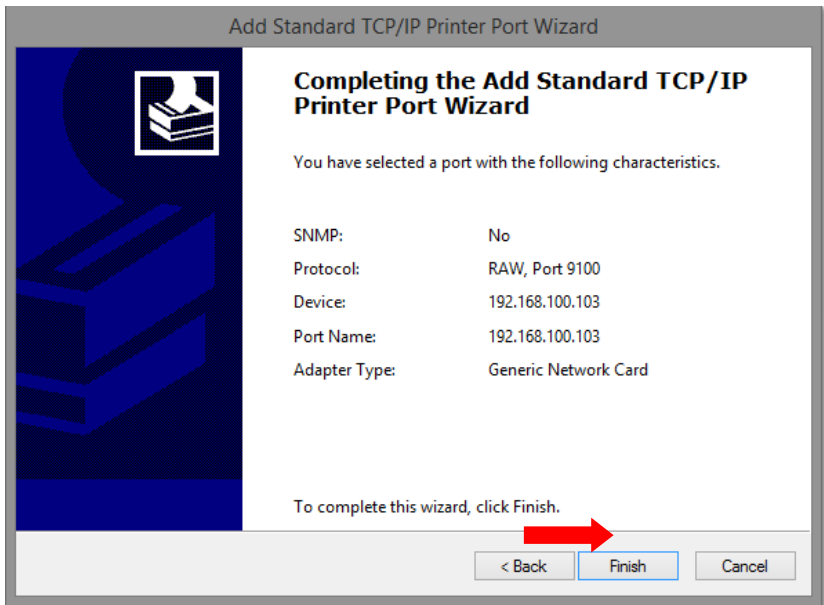
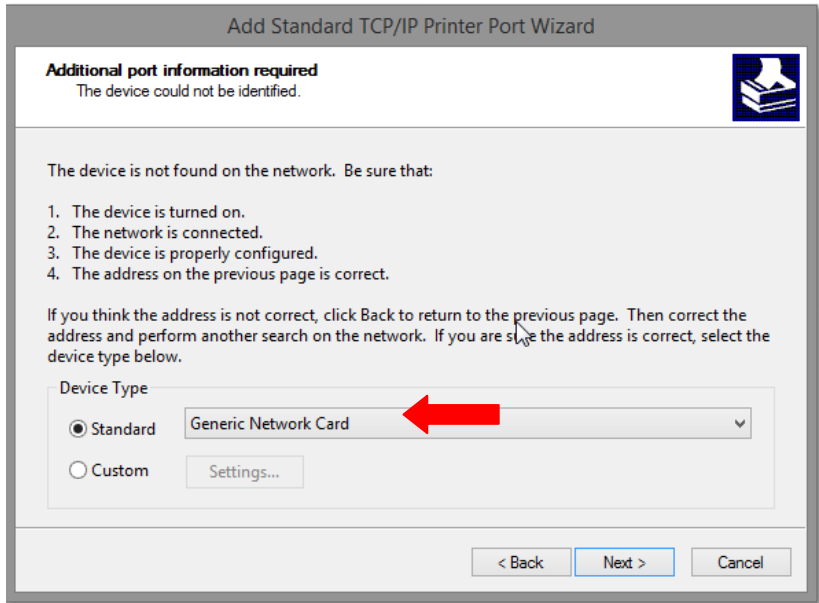



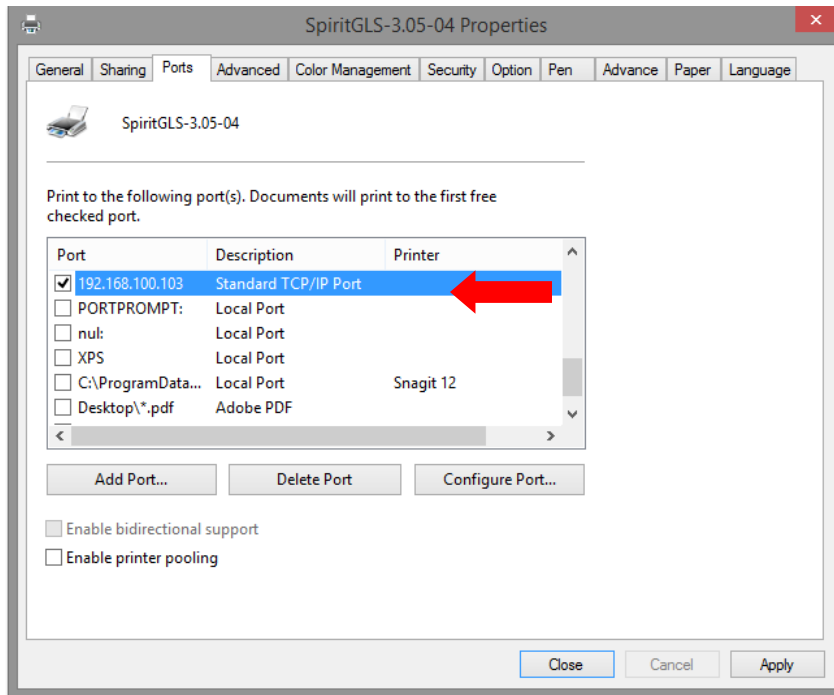

#### 4.1.2.2 Ethernet Connectivity Setup

GCC laser engraver is built-in with LAN port to transmit data from PC to laser engraver with ease and higher speed instead of USB port option.

Step 1. Connect LAN cable to the LAN port of GCC laser engravers and turn on machine

Step 2. Navigate the control panel through <F4> Function→ <Machine Setting>→ <LAN Setup Wizard>→ DHCP: OFF.

Step 3. Navigate the control panel through <F4> Function→ <Machine Setting>→ <LAN Setup Wizard>→ IP Address.

Step 4. Enter 192,168,3.X (X refers to 1~255 value which can't be the same value with IP address setting in PC or Notebook) for IP, and 255.255.255.0 for MASK with UP/ DOWN keys.

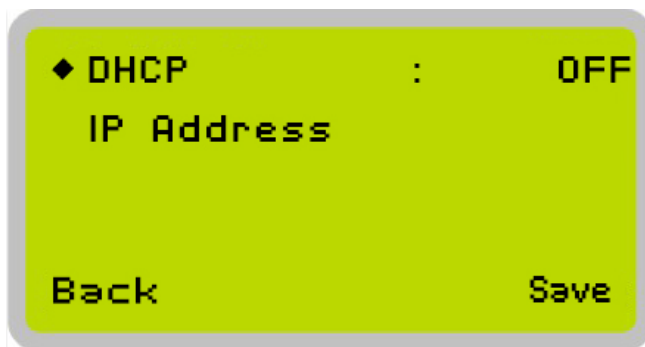

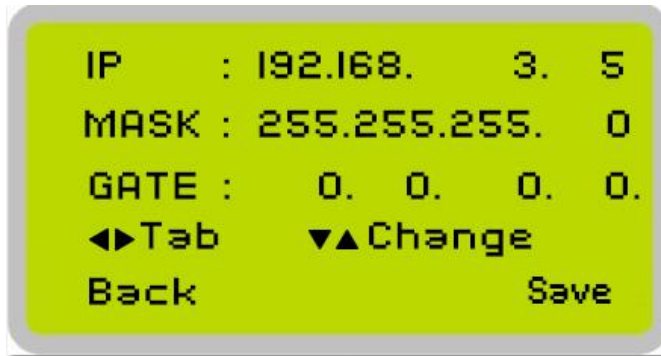

Step 5. Go to <Control Panel→Network and Internet→Network Connections> of computer, right click mouse on the connected internet device, and choose <Properties>

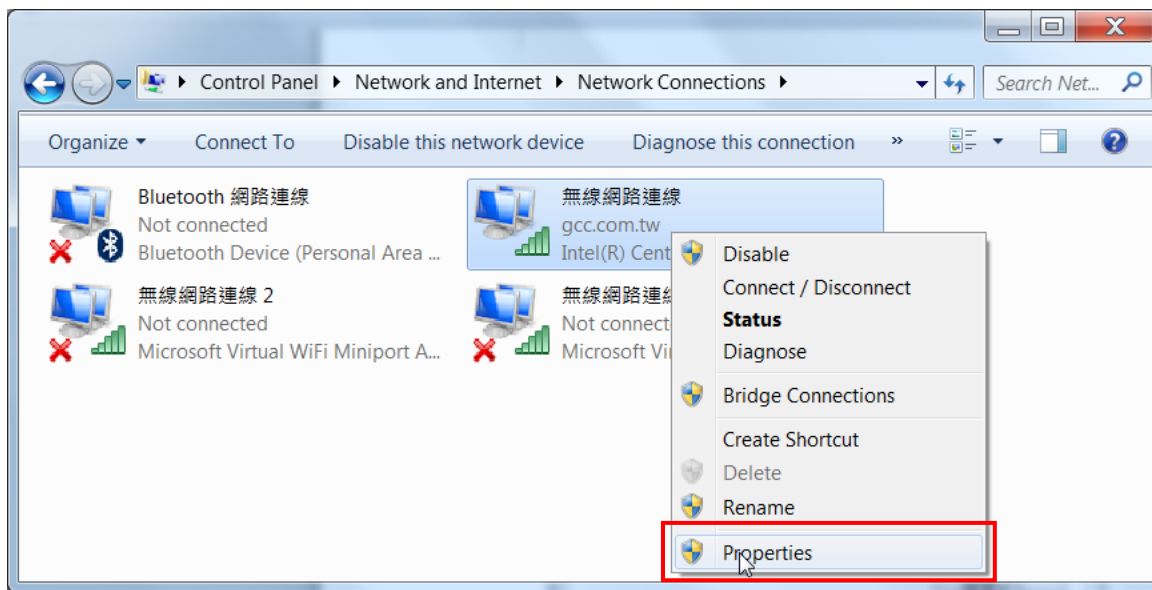

Step 6. Choose the <Internet Protocol Version 4(TCP/IPv4)> and click <Properties> to open up the setting window.

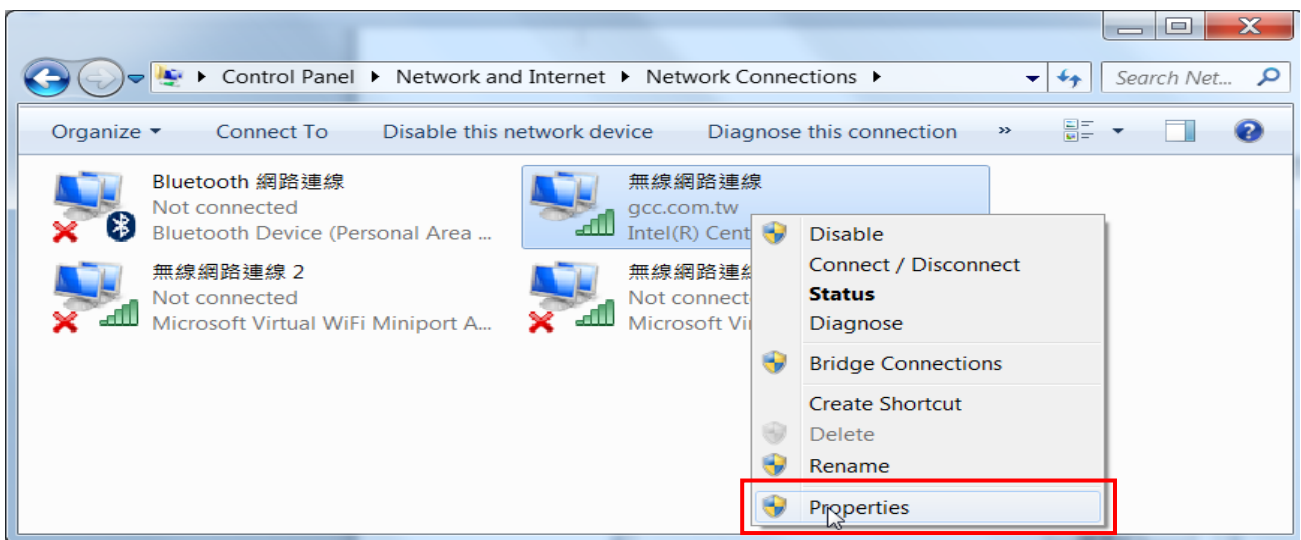
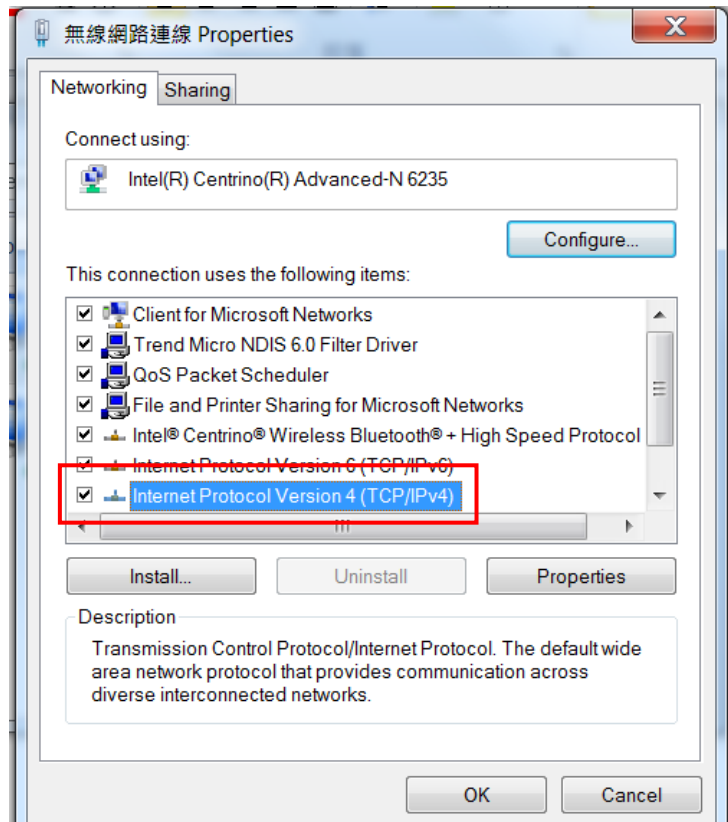

Step 7. Enter the IP address and Subnet mask setting values, and choose <OK>

Note the IP address 192.168.3.X (X value can be 1~255, while can't be the same number as machine control panel setting in step 4)

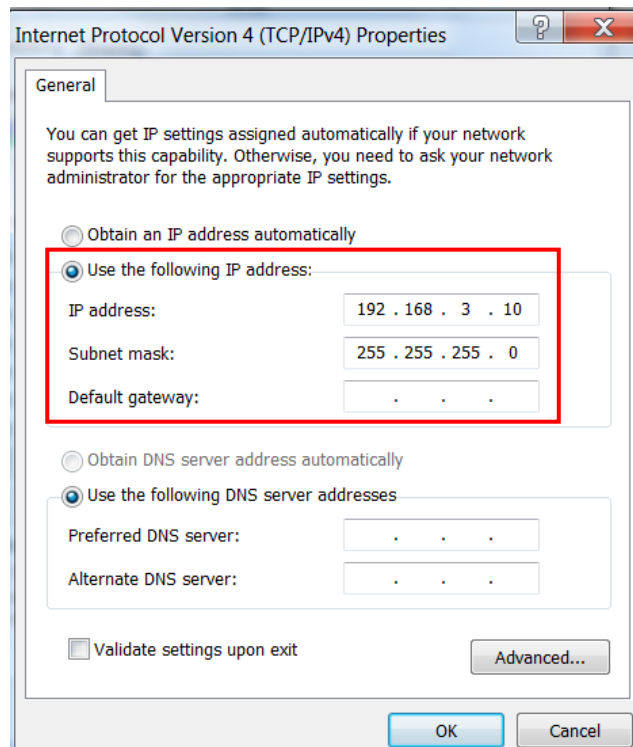

Step 8. Go to <Control Panel> → <Device and Printers> of computer and right click on the laser machine printer, choose <Printer Properties>.

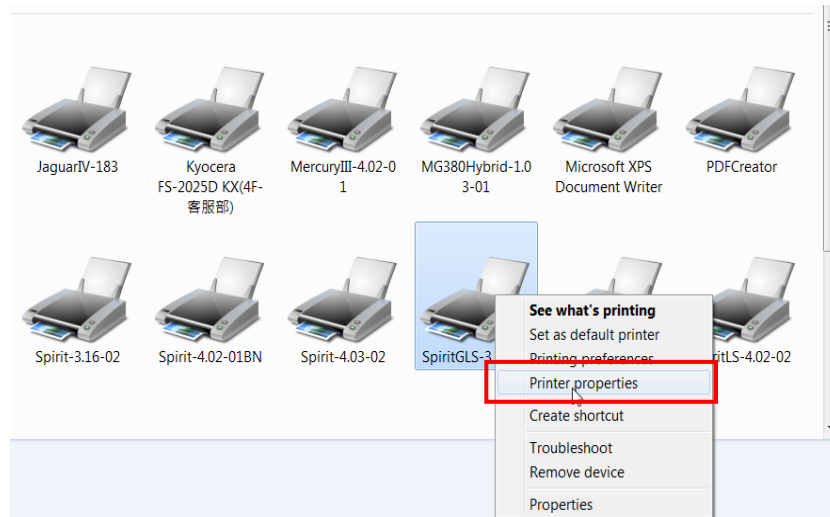

Step 9. Select <Add Pot> under Ports tab, and follow the instruction to enter the TCP/IP information in laser machine's control panel in step 4.

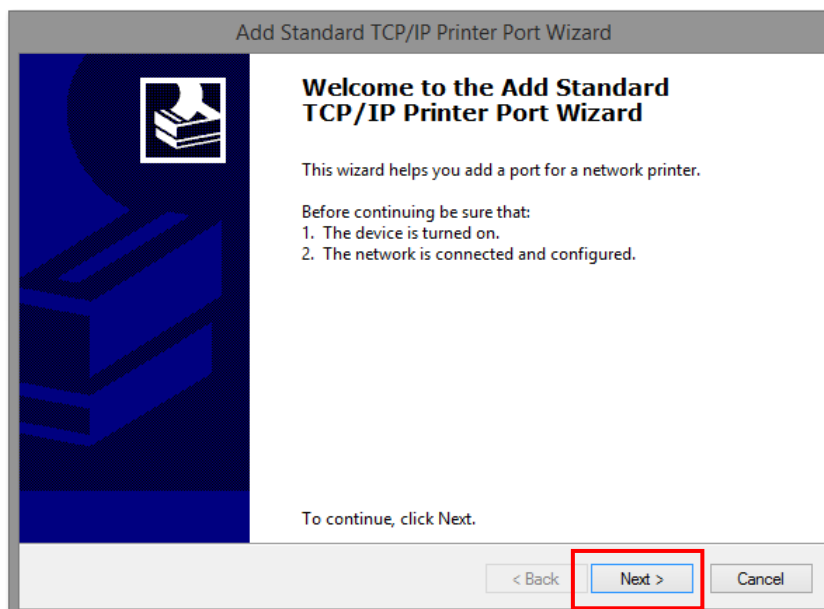
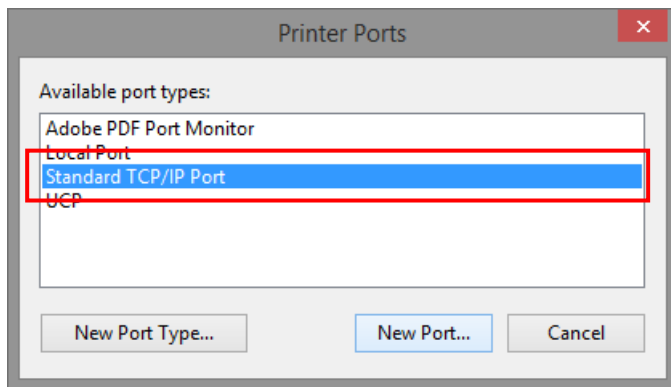
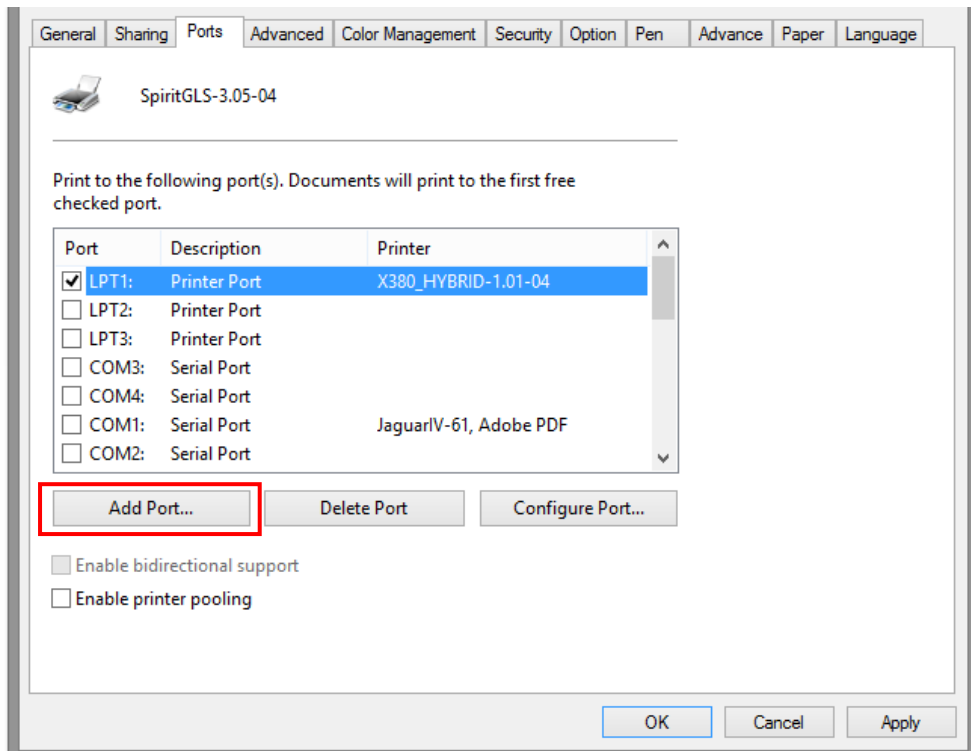

Add Standard TCP/IP Printer Port Wizard

**Add port**  
For which device do you want to add a port?

Enter the Printer Name or IP address, and a port name for the desired device.

Printer Name or IP Address:

Port Name:

< Back   Next >   Cancel

Add Standard TCP/IP Printer Port Wizard

**Additional port information required**  
The device could not be identified.

The device is not found on the network. Be sure that:

1. The device is turned on.
2. The network is connected.
3. The device is properly configured.
4. The address on the previous page is correct.

If you think the address is not correct, click Back to return to the previous page. Then correct the address and perform another search on the network. If you are sure the address is correct, select the device type below.

Device Type

Standard    Custom   Settings...

Generic Network Card

< Back   Next >   Cancel

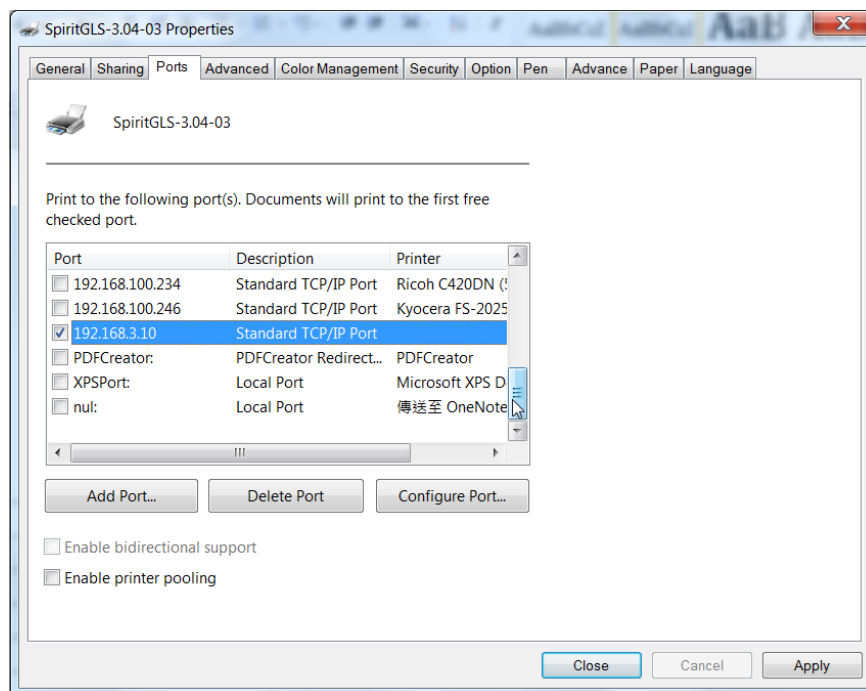
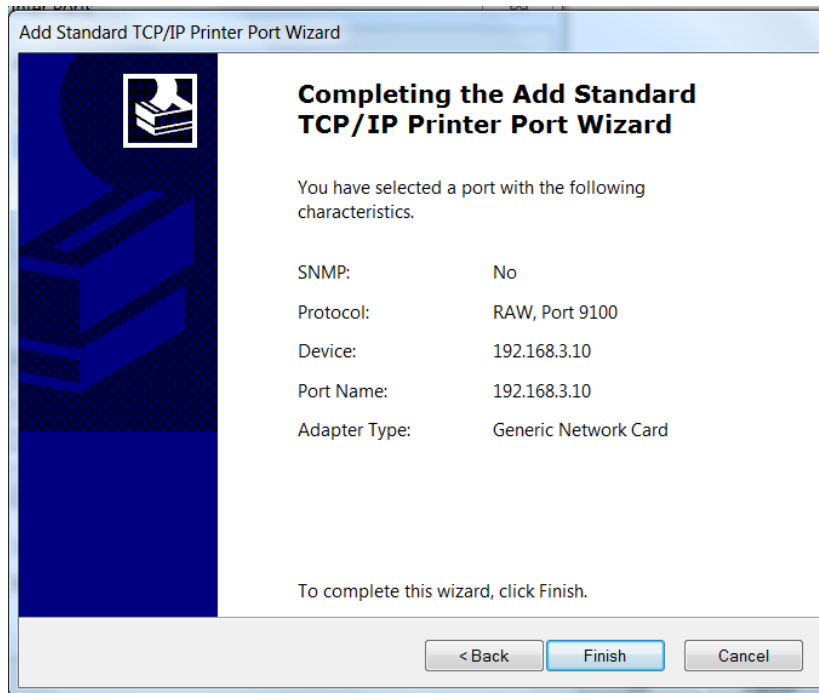

## Troubleshooting

While users configure the Ethernet setting precisely with DHCP = OFF (assign the machine a static IP) referring to the manual, sometimes the communication might still not be able to work, at this time you can refer to below actions to have a basic troubleshooting with IT technician.

**1. Verify the IP addresses you are using to see if they are valid.**

- i. Open command line mode in your windows system (Press Windows key + R, the “Run” window will appear, type “CMD” in the blank bar then press “OK” to open command line mode)

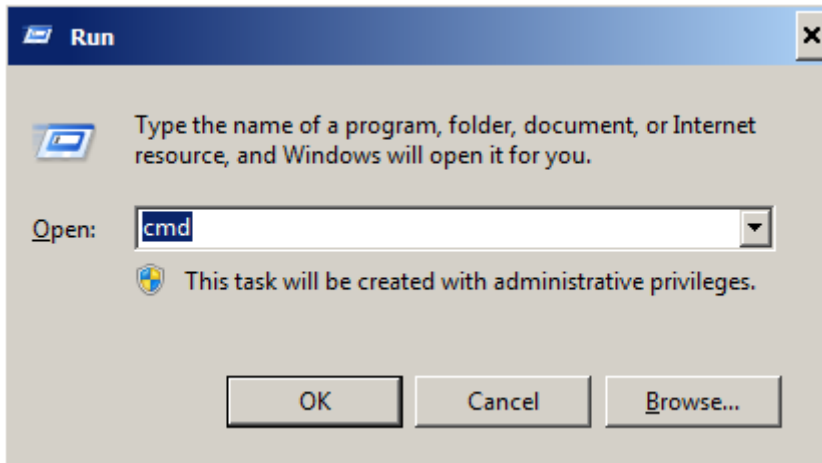

Command line mode window

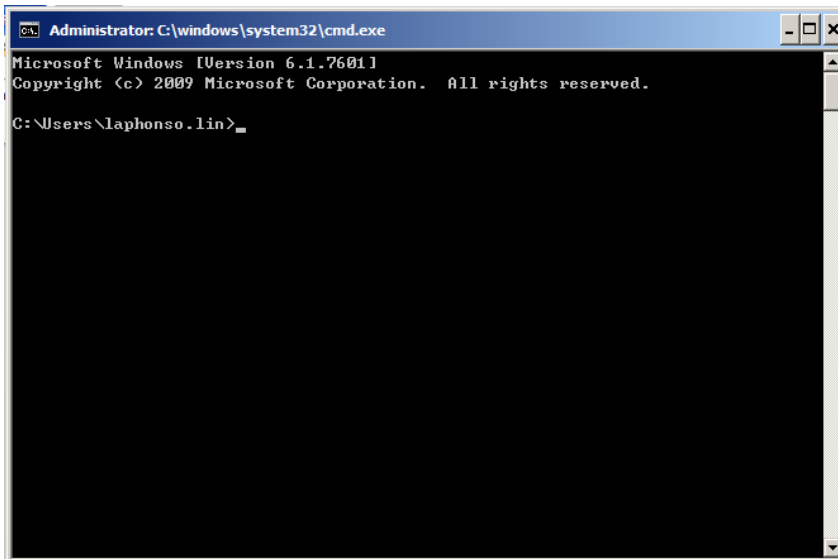



- ii. Type “ping x.x.x.x -t” after the prompt symbol, (x.x.x.x is the IP address you set on the laser machine, ie: 192.168.100.101)., press “Enter” to run the “Ping” tool.

```
Administrator: C:\windows\system32\cmd.exe - ping 192.168.100.101 -t

C:\Users\laphonso.lin>ping 192.168.100.101 -t

Pinging 192.168.100.101 with 32 bytes of data:
Reply from 192.168.100.101: bytes=32 time=7ms TTL=126
Reply from 192.168.100.101: bytes=32 time=3ms TTL=126
Reply from 192.168.100.101: bytes=32 time=2ms TTL=126
Reply from 192.168.100.101: bytes=32 time=2ms TTL=126
Reply from 192.168.100.101: bytes=32 time=2ms TTL=126
Reply from 192.168.100.101: bytes=32 time=4ms TTL=126
Reply from 192.168.100.101: bytes=32 time=3ms TTL=126
Reply from 192.168.100.101: bytes=32 time=2ms TTL=126
```

If the communication is OK between your PC and Laser machine, you will see reply from the destination IP.

If the communication is not ok, you will see “Request timed out” message from destination IP.

```
Administrator: C:\windows\system32\cmd.exe - ping 192.168.100.101 -t

C:\Users\laphonso.lin>ping 192.168.100.101 -t

Pinging 192.168.100.101 with 32 bytes of data:
Request timed out.
Request timed out.
Request timed out.
Request timed out.
```

## 2. Diagnostics

- a. For cases the communication is not ok (can't get response, just have “Request timed out” from destination IP), you can look for two PC/Laptops which are original set in the LAN environment and work ok (they can get normal response from each other by the command “PING”), note down the TCP/IP configurations by running “ipconfig” on both PC/Laptops (press “Windows key + R” to call the “Run” windows, type “CMD” in the blank bar, press enter to start command line mode,

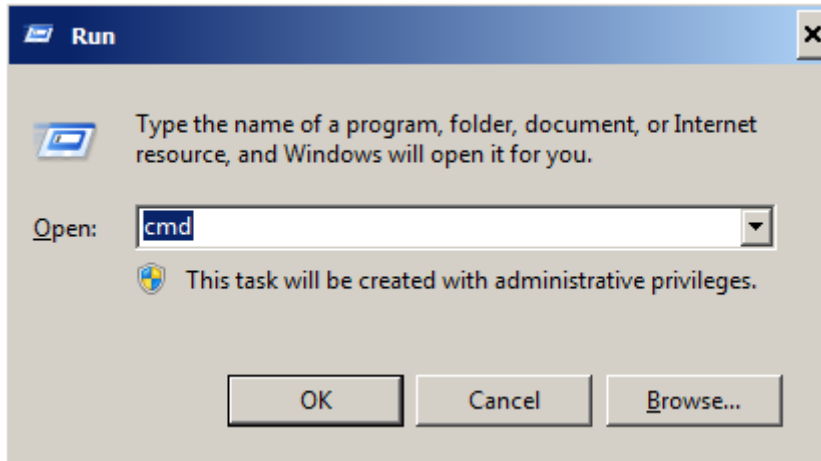

type "ipconfig" after the prompt symbol then press enter, the TCP/IP configurations of this PC/Laptop will show as below)

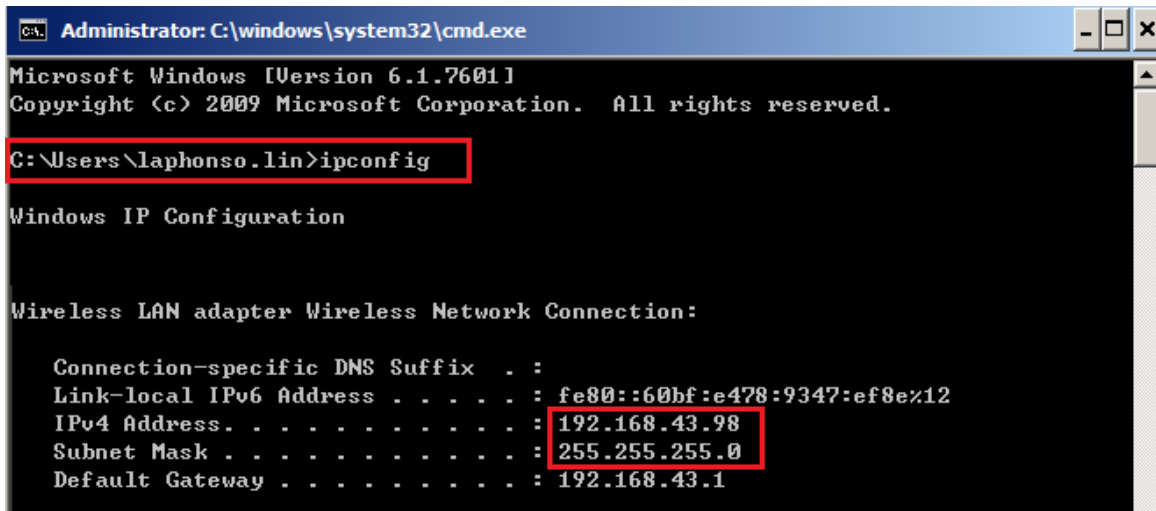

Set those two IP addresses to the laser machine and the PC/Laptop which you want to communicate with laser.

Test Ping again to see if you can get normal response from destination IP, if the communication is normal now (can get reply from destination IP), we can be sure the IP addresses we set originally are invalid, ask the LAN administrator to provide us a proper one.

- b. Directly connect the Laser machine and PC/Laptop using the RJ45 cable without any router/switch..etc. in between, test PING and send files, if the files can be sent and the result of PING is normal (can get response from destination IP), the Ethernet function of GCC laser is normal, it should be something wrong in the LAN environment , ask the administrator of the LAN to solve the problem.

### 4.1.3 USB Storage Setup

GCC laser engraver is built-in with USB storage port allow you to transmit data from USB flash drive. You can format and use a USB flash drive as an USB storage of GCC laser engraver.

#### USB flash drive minimum requirements

- Windows FAT16/FAT32 file system format
- A maximum of 32G of storage capacity

Following are our certified brands for GCC LaserPro USB storage

Brand	Size	Format
HP	16G	FAT32
SanDisk	16G	
PNY	8G	
Kingston	8G / 16G	
Transcend	4G / 16G	
ADATA	8G / 32G	

Step 1. Make sure the page setup and orientation is match GCC LaserPro Spirit / Spirit LS / Spirit GLS Hybrid. Please refer to Chapter 5.2.1 for page setup and orientation.

Step 2. Open the file in graphics software and click File → Print from menu bar, and the Print window will appear

Step 3. From the navigation bar Printer. Click Spirit / Spirit LS / Spirit GLS Hybrid.

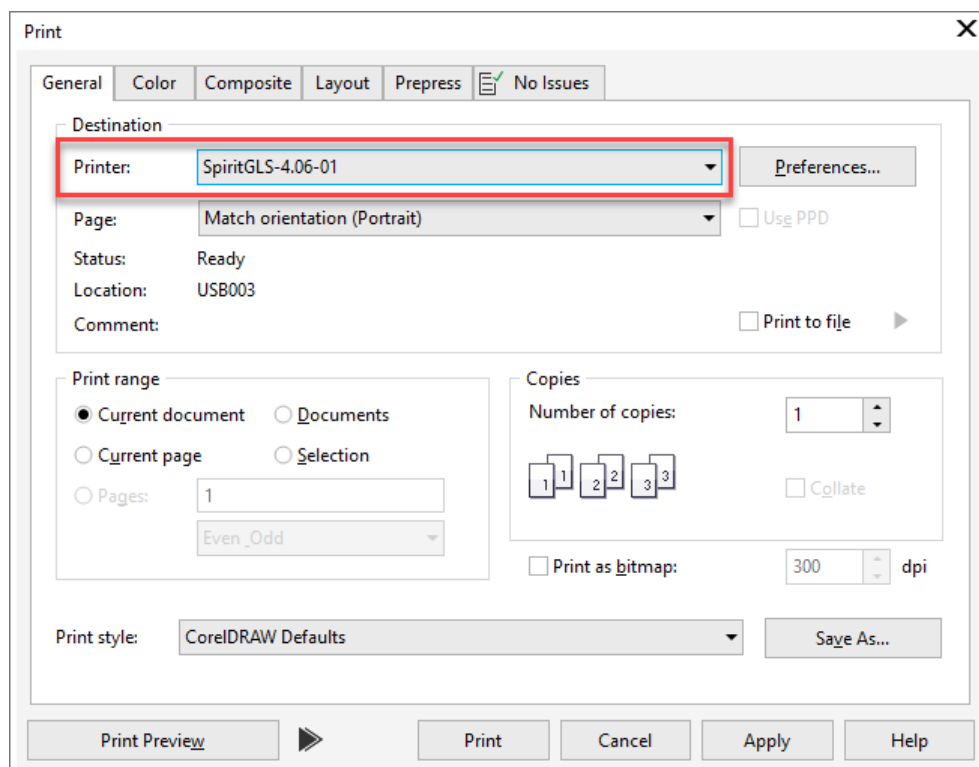

Step 4. Checking the Print to file checkbox and click the Print button.

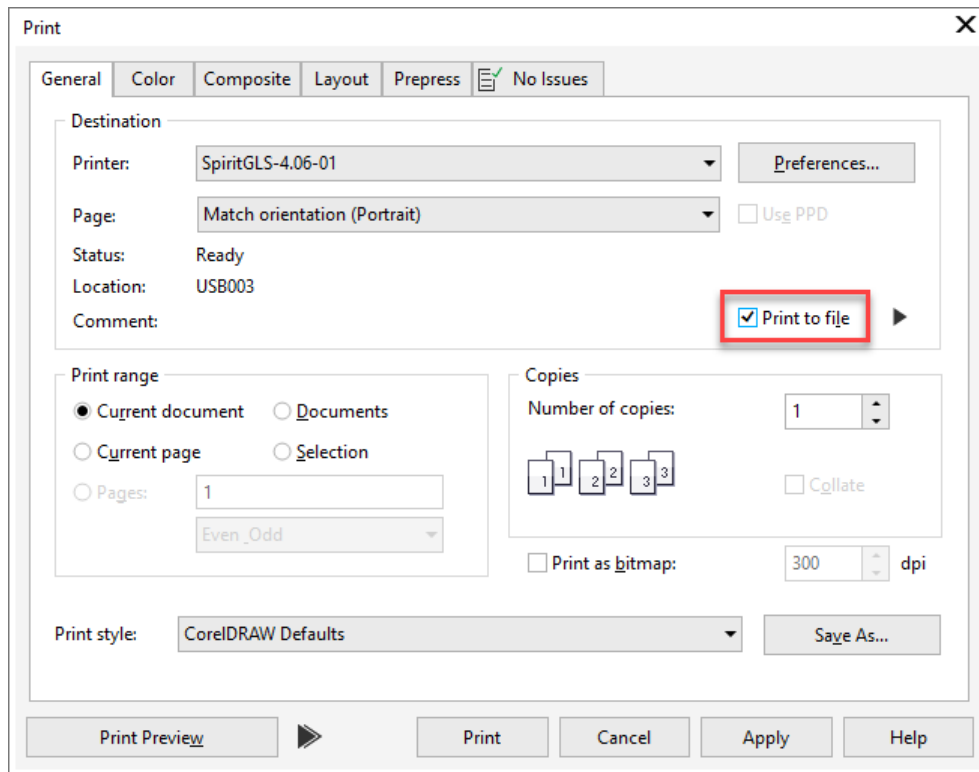

Step 5. Select the save folder and define file name, then click "Save" to convert

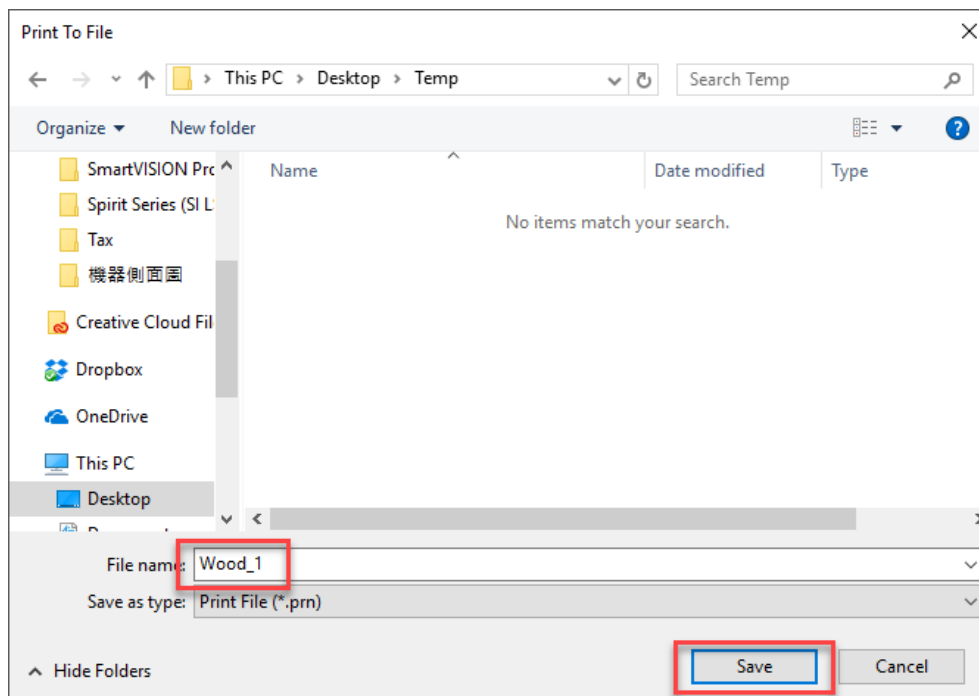

Step 6. Move the file to the USB flash drive

Step 7. Insert USB flash drive to the USB Storage port of GCC laser engravers.



#### NOTE

- USB storage function only supported for the PRN format, you can convert the file to PRN format from the GCC LaserPro printer driver.

Step 8. Navigate the control panel through <F4> Function → <File Management> → <USB Drive File>

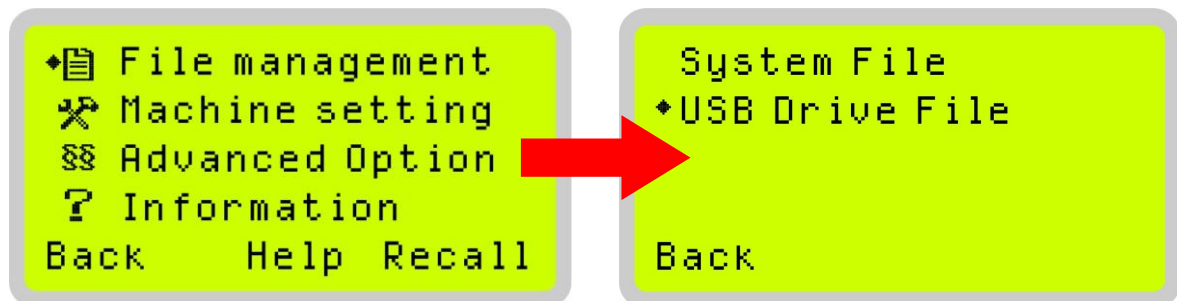

Step 9. Choose the file and press Enter button from control panel to transmit the file to laser engraver.

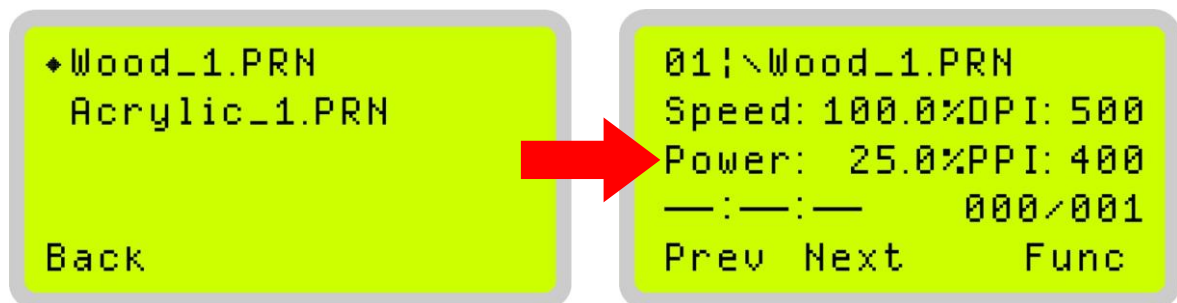

Step 10. Press START button on control panel to begin laser jobs.

## NOTE

- File cannot be write to laser machine, please do not remove the USB flash drive if you want to keep process the job.

## 4.2 Graphics Software Setup

The LaserPro Spirit Series is compatible with graphics software that can output HPGL commands, such as CorelDRAW, Adobe Photoshop, AutoCAD, Illustrator etc.

### Supported Graphic Software

- Photoshop
- CorelDRAW
- Illustrator
- AutoCAD

Other software such as EngraveLab and PhotoGrav may work with the LaserPro Spirit Series, but LaserPro does not guarantee 100% compatibility for those software and will not provide technical support for them.

### NOTE

Technical support will not be offered, if you experience output problems with non-supported graphics software.

### 4.2.1 Recommended Computer Configuration

The LaserPro Spirit Series operates under Windows operating systems and is designed to work on a computer that meets the following minimum requirements.

#### Computer Compatibility

- CPU – Pentium 90 (or equivalent) or greater
- RAM – 32 MB or higher
- HDD – 1.2 GB Hard Drive or greater
- SVGA – 15" Super VGA Monitor
- On Board Parallel Mode (Enabled from motherboard's BIOS)
- SPP – Preferred Mode
- ECP – Cable (Less than 1.8 meters)

#### Software Compatibility

- The LaserPro Spirit Series drivers are designed for Windows Vista, 7, 8, or other operating systems developed subsequently.

## 4.3 Installation of the LaserPro Print Driver

- 1) Insert the LaserPro CD.
- 2) From the auto run menu, select Model Name; LaserPro Driver to begin the LaserPro Print Driver installation.
- 3) When the Add Printer Wizard menu comes up, click Next to continue.
- 4) At the Local or Network Printer page, select <Local printer attached to this computer>, then click Next to continue.
- 5) At the Select a Printer Port page, select <Use the following port> and select the port that the LaserPro Spirit will be attached to, then click Next to continue.
- 6) The next screen will prompt you with a list to select the manufacturer and model of your printer. From this menu, click Have Disk. Another menu will now pop up for you to indicate the location of the print driver. With the LaserPro CD still in your drive, click Browse, select the LaserPro Spirit

driver folder and locate the GL345.inf file. Click OPEN to have Spirit displayed as a valid printer.

- 7) Now select Spirit from the list of printers (Spirit should be the only printer displayed on the list) and click Next to continue.
- 8) If a screen comes up informing you of the detection of a previous driver and asks to keep the existing driver or use the new one, select <Replace Existing Driver> and click Next to continue.
- 9) This screen will prompt you to provide a printer name. Simply type in <Spirit> and select Yes or No if you want to use this printer as the default printer and click Next to continue.

## NOTE

When working with the LaserPro Spirit Series Print Driver within your graphics software, you will need to have the Spirit set as the default printer to get proper output. If you select to not have the Spirit be the default printer, please remember to manually change this

on your own from within the graphic software printer selection area or from the Windows Control Panel Printers and Faxes section.

- 10) At the Printer Sharing screen, select <Do not share this printer> and click Next to continue.
- 11) Select <No> when asked if you want to print a test page and click Next to continue.
- 12) Now simply click Finish to complete the Add Printer Wizard.
- 13) Now the installation will proceed, if you get a Hardware Warning about the software you are installing for this hardware has not passed Windows Logo testing, simply click Continue Anyway to ignore this warning.
- 14) Congratulations, your printer driver has been successfully installed!

## 4.4 Parallels Desktops for MAC Users

MAC users can use GCC LaserPro machines by purchasing the Parallels Desktop software which allows you to install Windows OS in MAC computers and run Windows based software under MAC computer and output with GCC print driver.

- 1) Purchase Parallels Desktops on its official website.



**Parallels Desktop 8 for Mac**  
The #1 choice of customers worldwide to run Windows on Mac

Parallels Desktop 8 for Mac lets you seamlessly run Windows and Mac applications side-by-side, without rebooting.

Enjoy the latest **Mountain Lion** and Lion features in Windows apps, and remotely access your Windows and Mac programs from your **iPad** or **iPhone** with the Parallels Mobile app, available for purchase in the App Store.

In addition to Windows 7, other OSes can also be run in **Parallels Desktop 8 for Mac**, including **Windows 8**, Windows Vista, Windows XP, Windows 98, **Linux**, and Google **Chrome OS**.

Buy \$79.99   Watch Video   Try Free

Upgrade now for \$49.99

The advertisement features a central image of a MacBook Air displaying the OS X Mountain Lion desktop. The background is red with white fireworks. Navigation arrows are visible on either side of the laptop. Three buttons are located below the laptop: 'Buy \$79.99' (orange), 'Watch Video' (blue), and 'Try Free' (green). A small text 'Upgrade now for \$49.99' is positioned below the buttons.



2) Install Parallels Desktops under Mac OS environment.

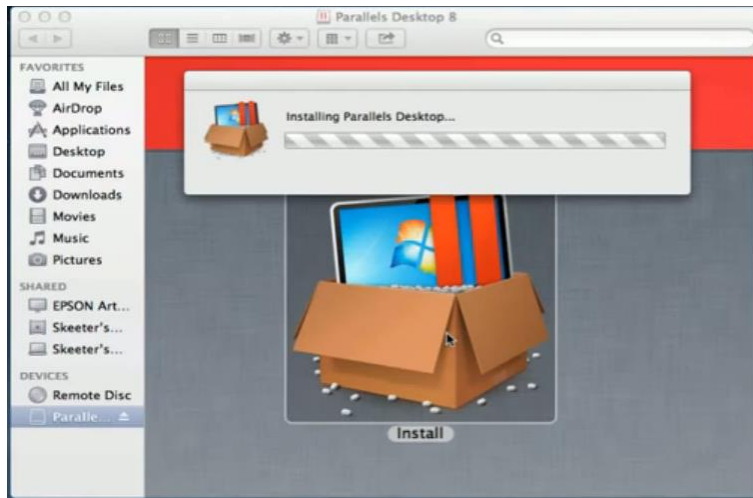

3) Read Software License Agreement and press “Accept” to continue installation

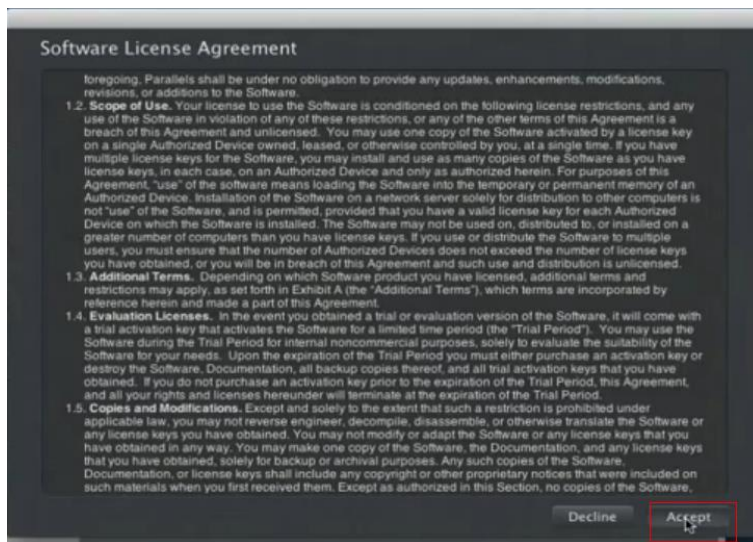

4) Enter your Mac OS X User Name and Password then press “OK”

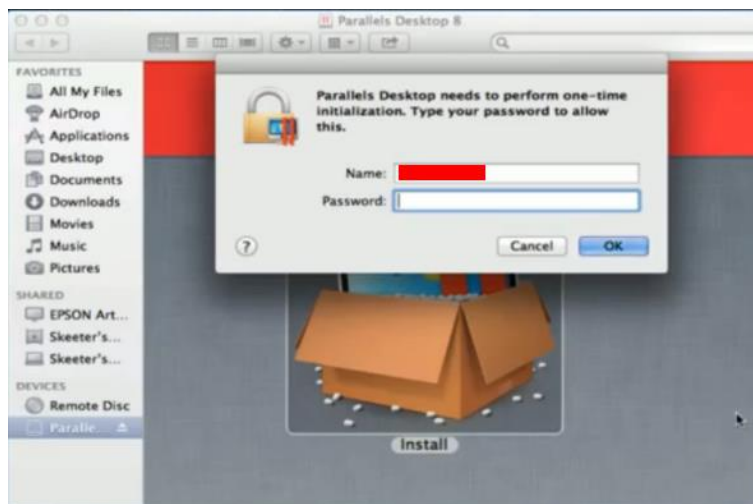

5) Press "Active"

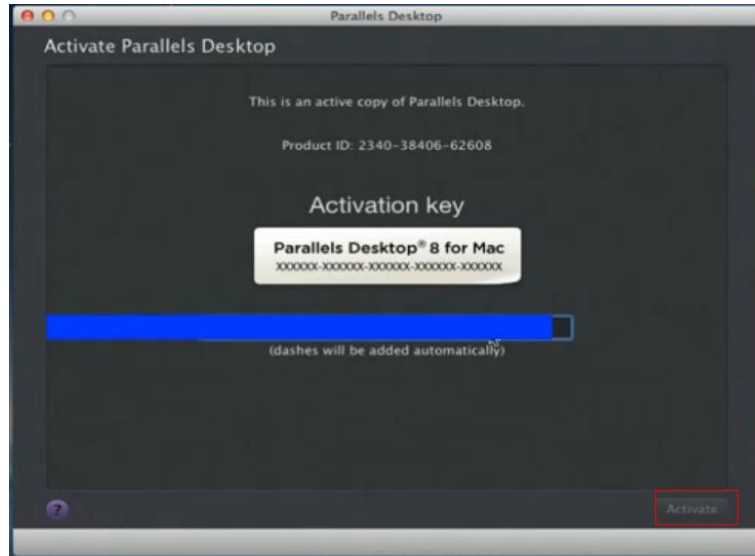

6) Press "OK" when activation is complete.

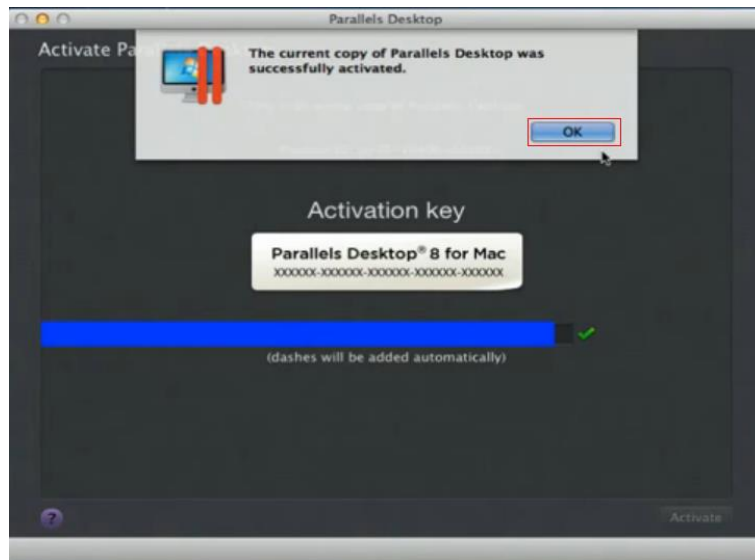

7) Register Parallels Desktop

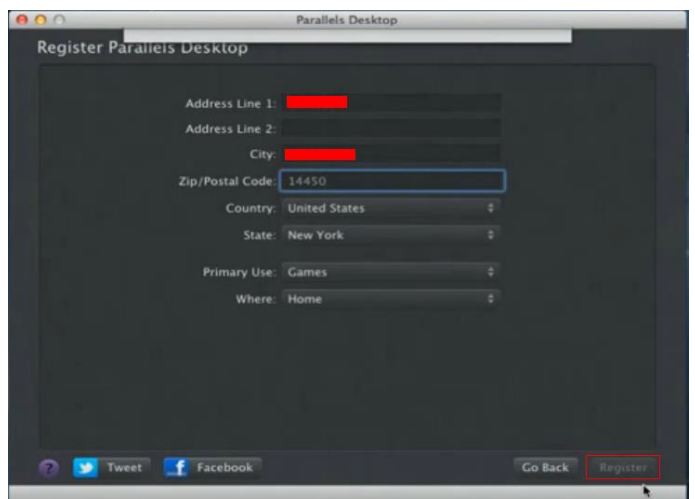
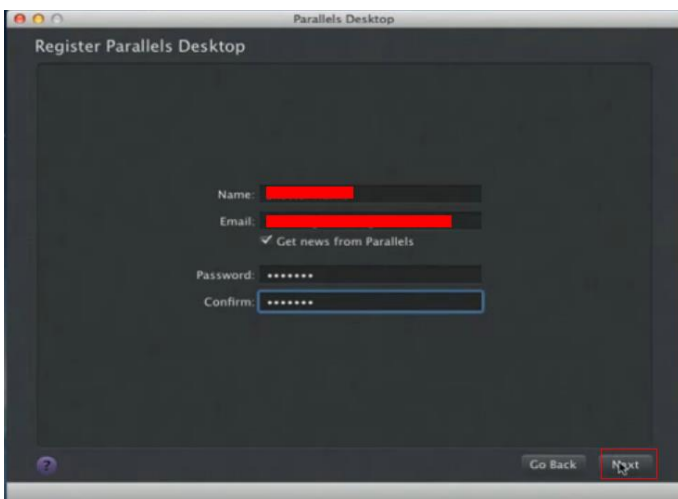

8) Press “Register” and “OK” to complete the installation of Parallels Desktop.

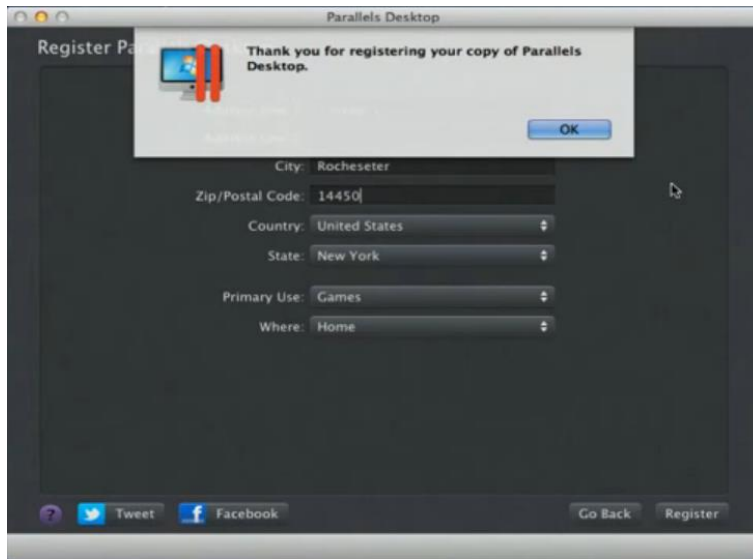

9) Open **Parallels Desktop** (in the **Applications** folder) then choose **File** → **New**

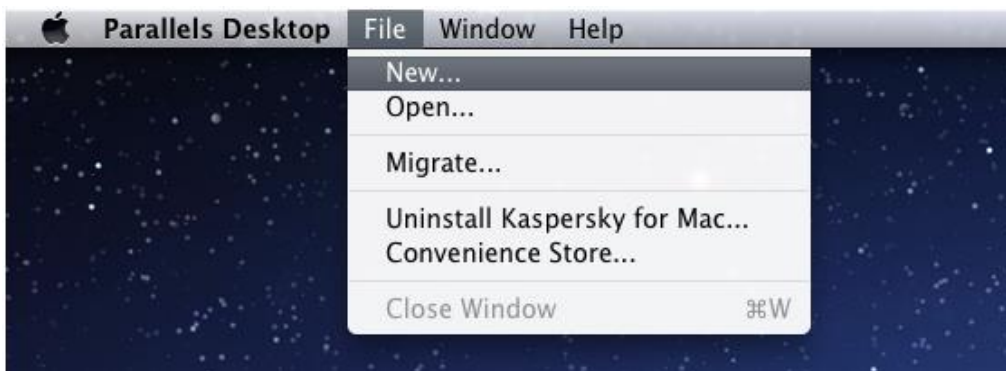

10) Press “Install Windows from DVD or image file” then press “continue” to install windows OS



11) Select CD-ROM drive with the Windows installation CD



12) Enter the Windows OS product key

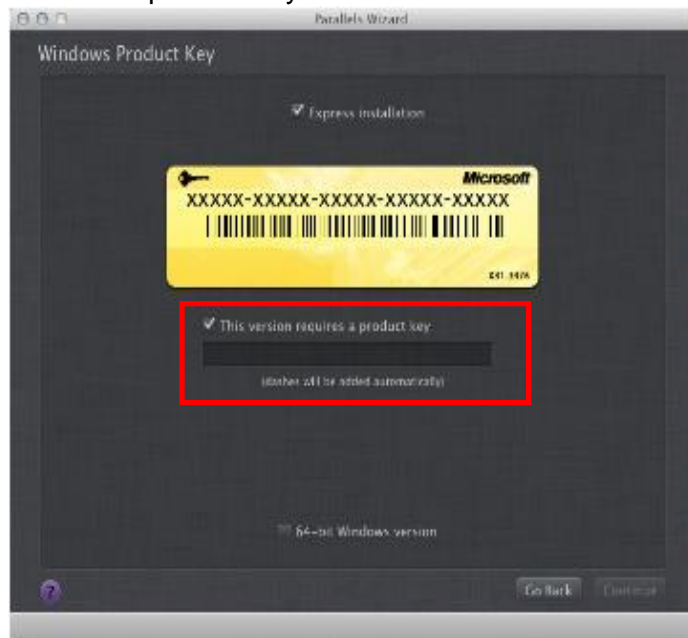

13) Select how you would like to run your Windows program.



14) After the prior setting is complete the windows OS installation procedure will start automatically.

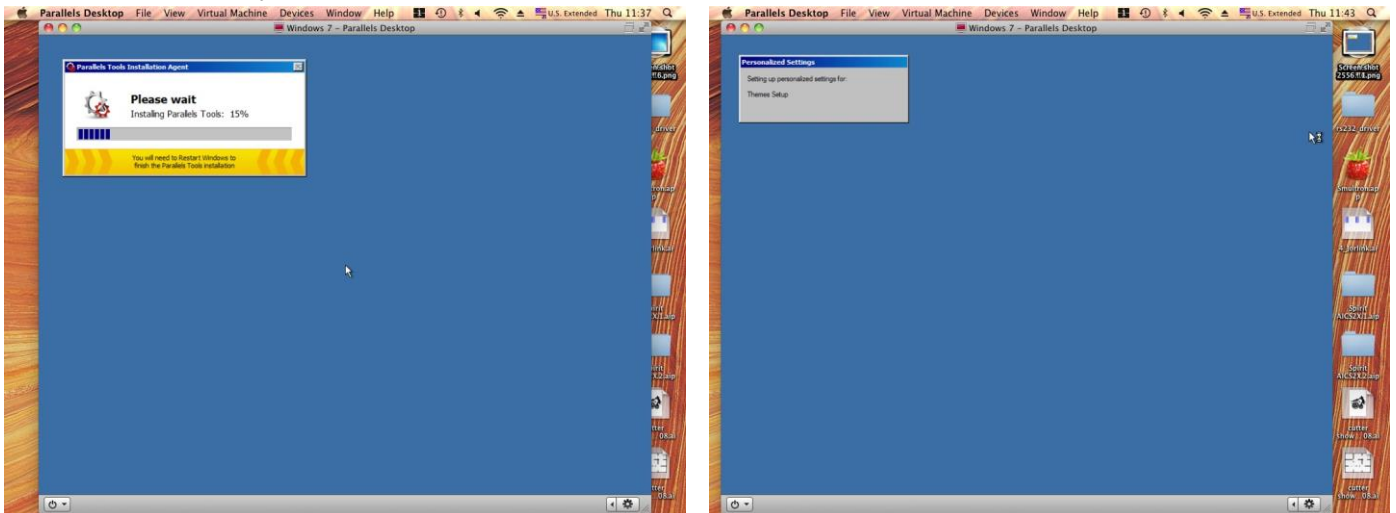

15) Windows OS installation is complete then you can refer to “4.6 Installation of the LaserPro Print Driver” to install GCC LaserPro Print Driver.

16) Install the AP that you want to use after the above installation is complete.



## 4.5 Using Adobe's AP with GCC LaserPro machine

The Adobe's AP (e.g. Illustrator, Photoshop or Acrobat reader) processes files via its Advanced Printing Features; users should firstly deselect Enable Advance Printing Features; otherwise the machine is unable to recognize or read general files when uploaded.

- Deselect "Enable Advance Printing Features"

1) Click to select → Control Panel → Devices and Printers

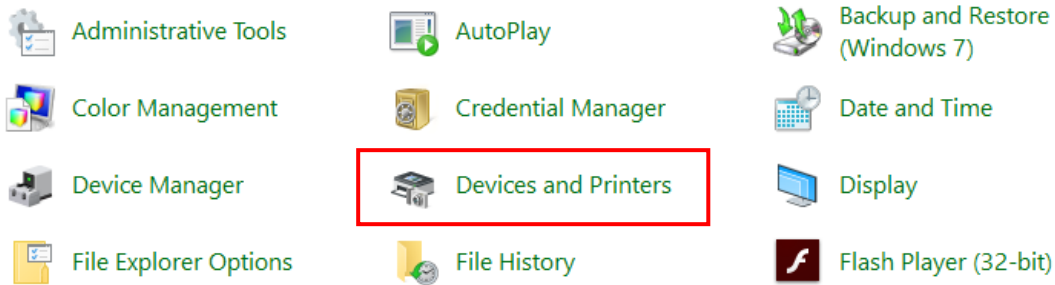

2) Select your printer (for example, Spirit), right-click your mouse and choose Properties to enter Spirit Properties setup

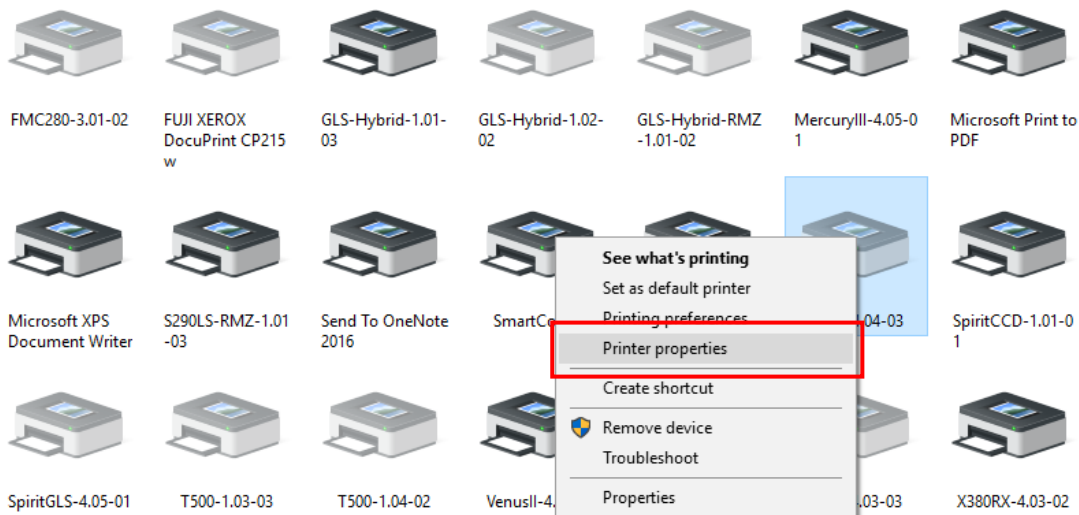

- 3) The click the Advanced tab, then deselect Enable Advanced Printing Features, now all files can be recognized and uploaded.

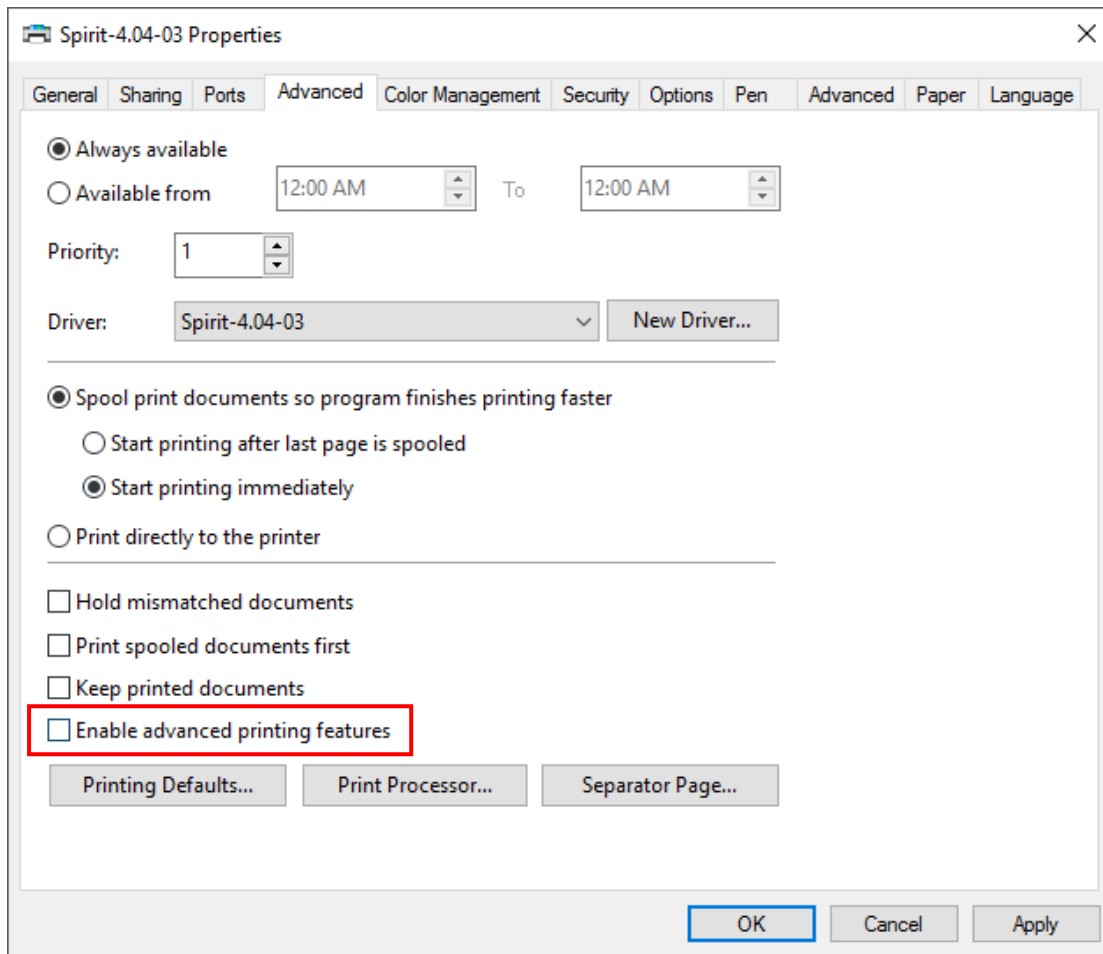

### ● File Transfer

- 1) Select your working object, and then at the upper toolbar please choose File → Print.

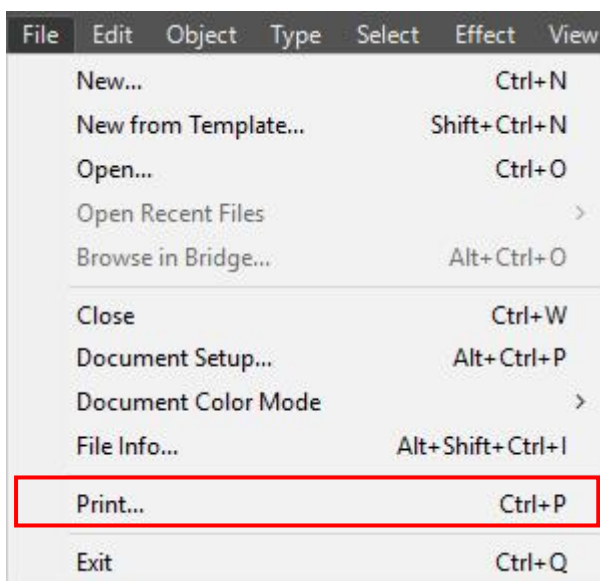

2) At the print setup screen, at Print Preset please select Custom, and choose your printer (e.g. Spirit)

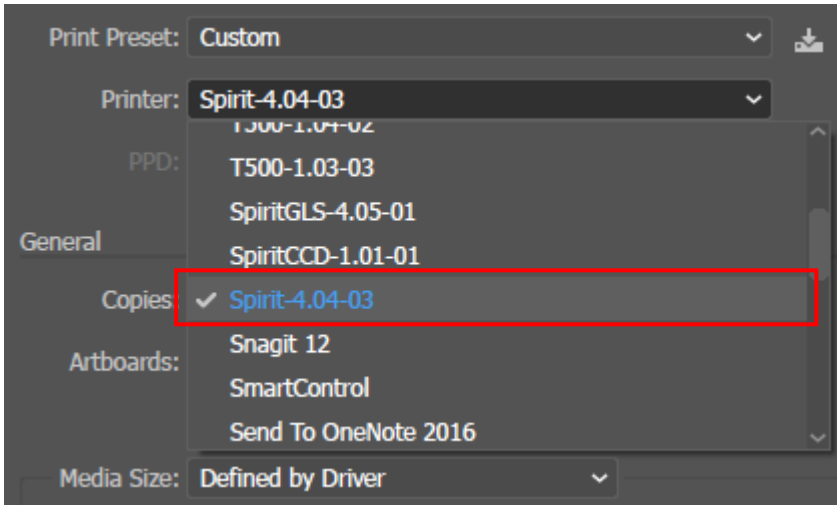

3) Then click on the lower left tab of Setup to enter Preferences settings.

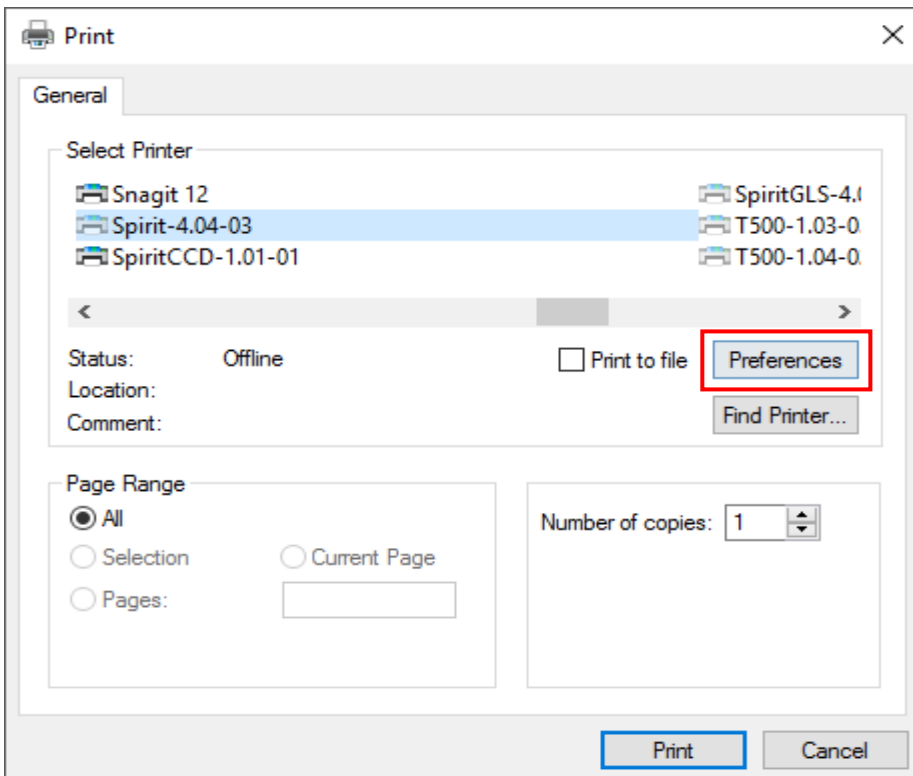
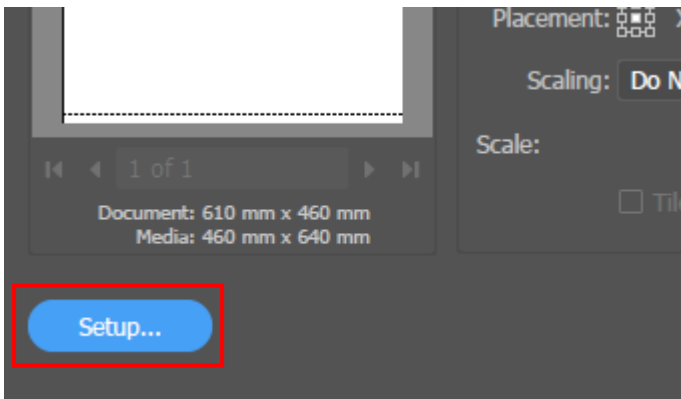



4) After all preferences are set, click Print to send file to the machine for print out.

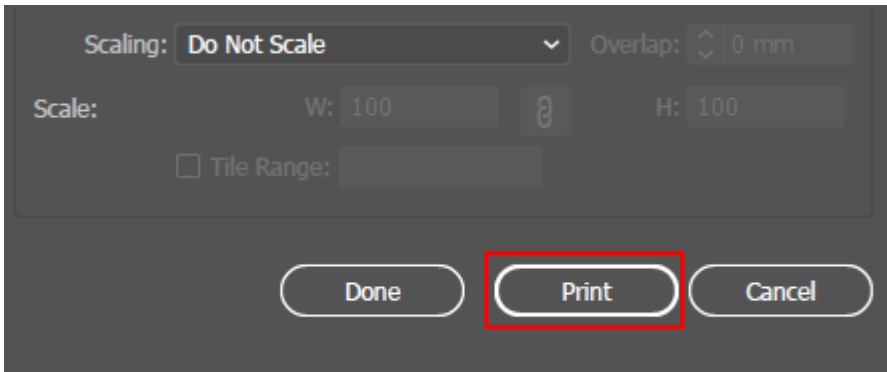

## 4.6 Using Autodesk Inventor with GCC LaserPro machine

1. Start drawing.

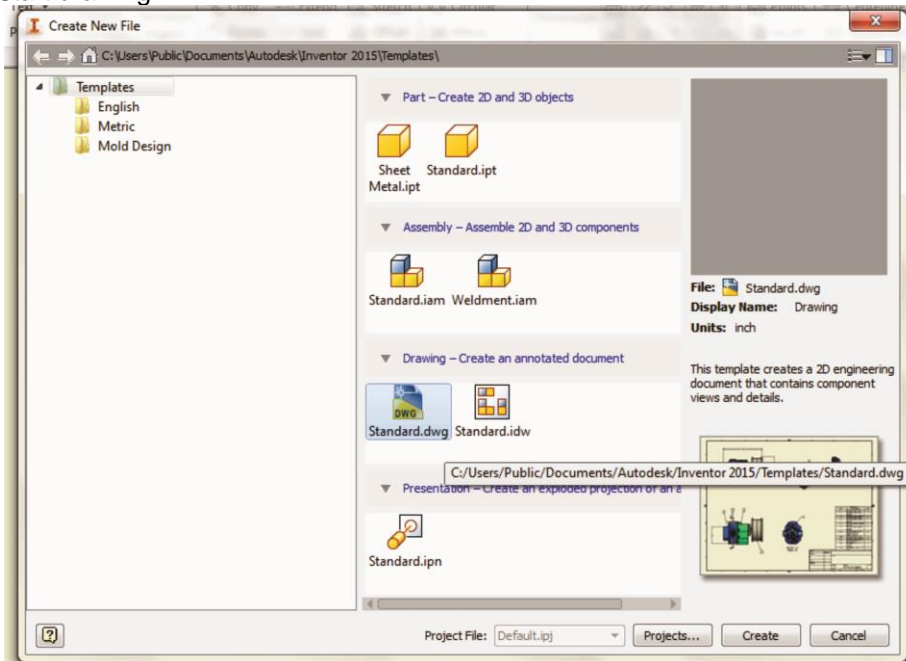

2. Delete border and title block by right clicking on sheet1 and selecting delete.

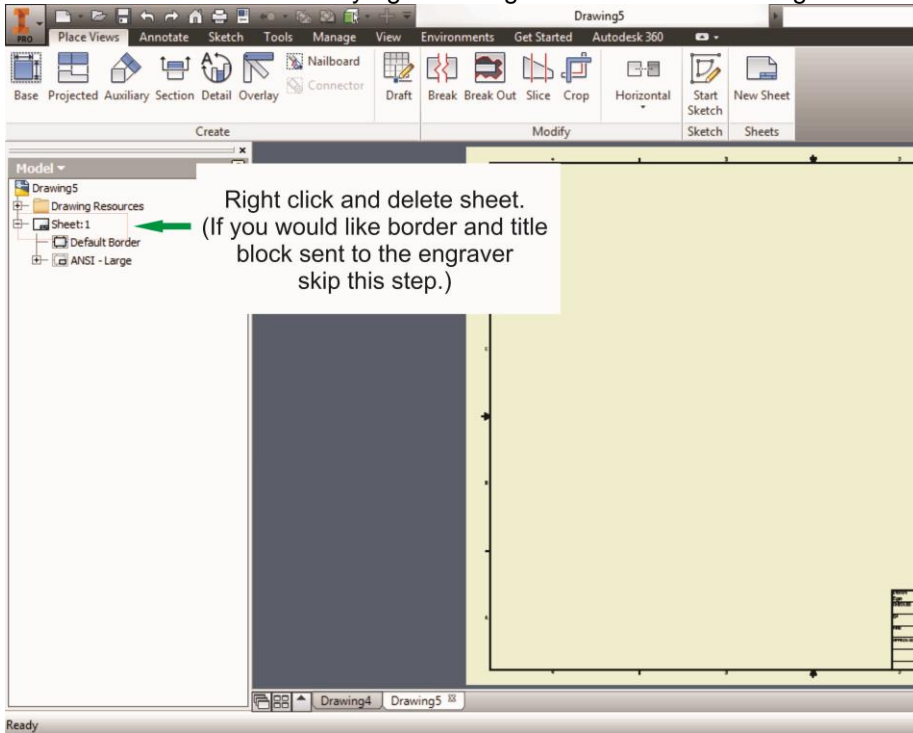

3. Set sheet size to match working area of engraver. Engraver working area can be found on the paper tab of the windows driver.

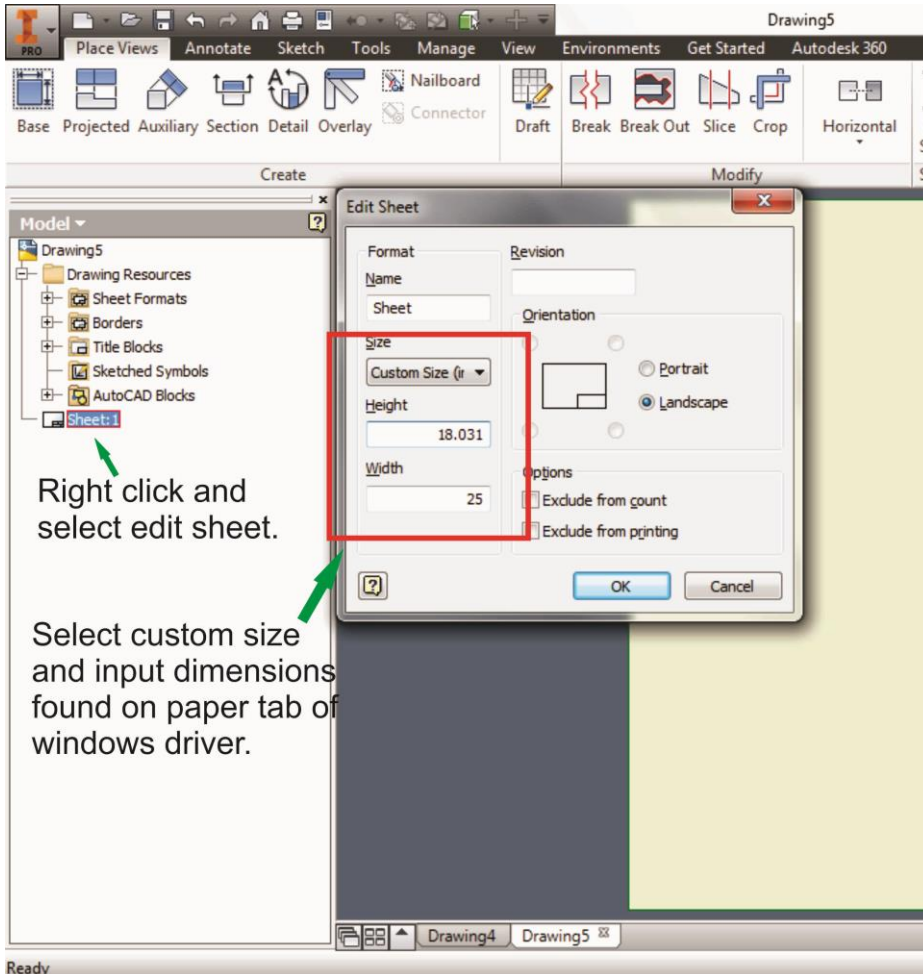

4. Start sketch.

## 5. Engraving

- a. Finish sketch.
- b. Right click on sketch and select properties.
- c. Line Type: By Layer
- d. Line Weight: By Layer
- e. Set color to match one of the 16 colors available in the pen tab of the windows driver.

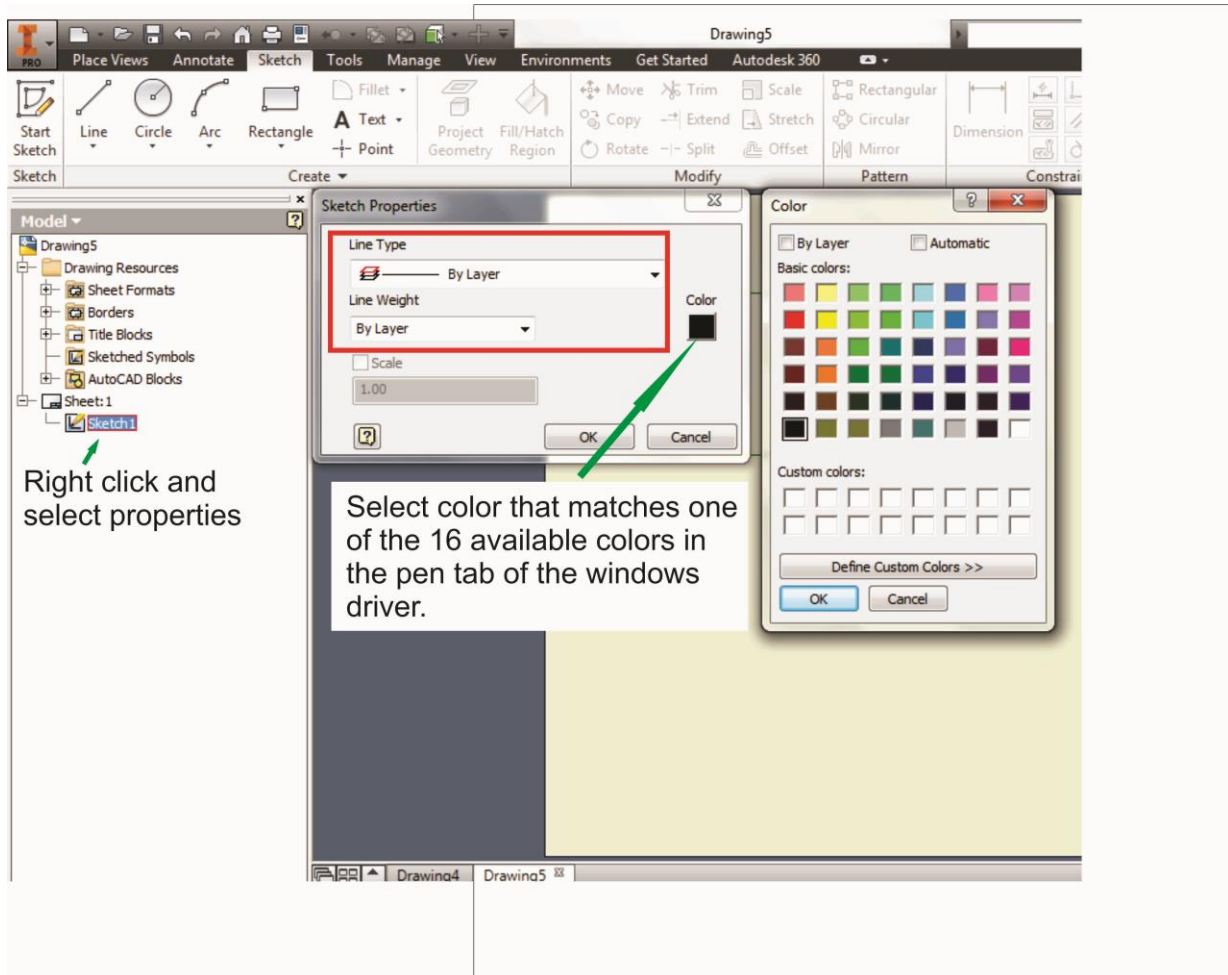

## 6. Cutting

- a. Finish sketch.
- b. Right click on sketch and select properties.
- c. Line Type: Continuous
- d. Line Weight: .001 in.
- e. Set color to match one of the 16 colors available in the pen tab of the windows driver.

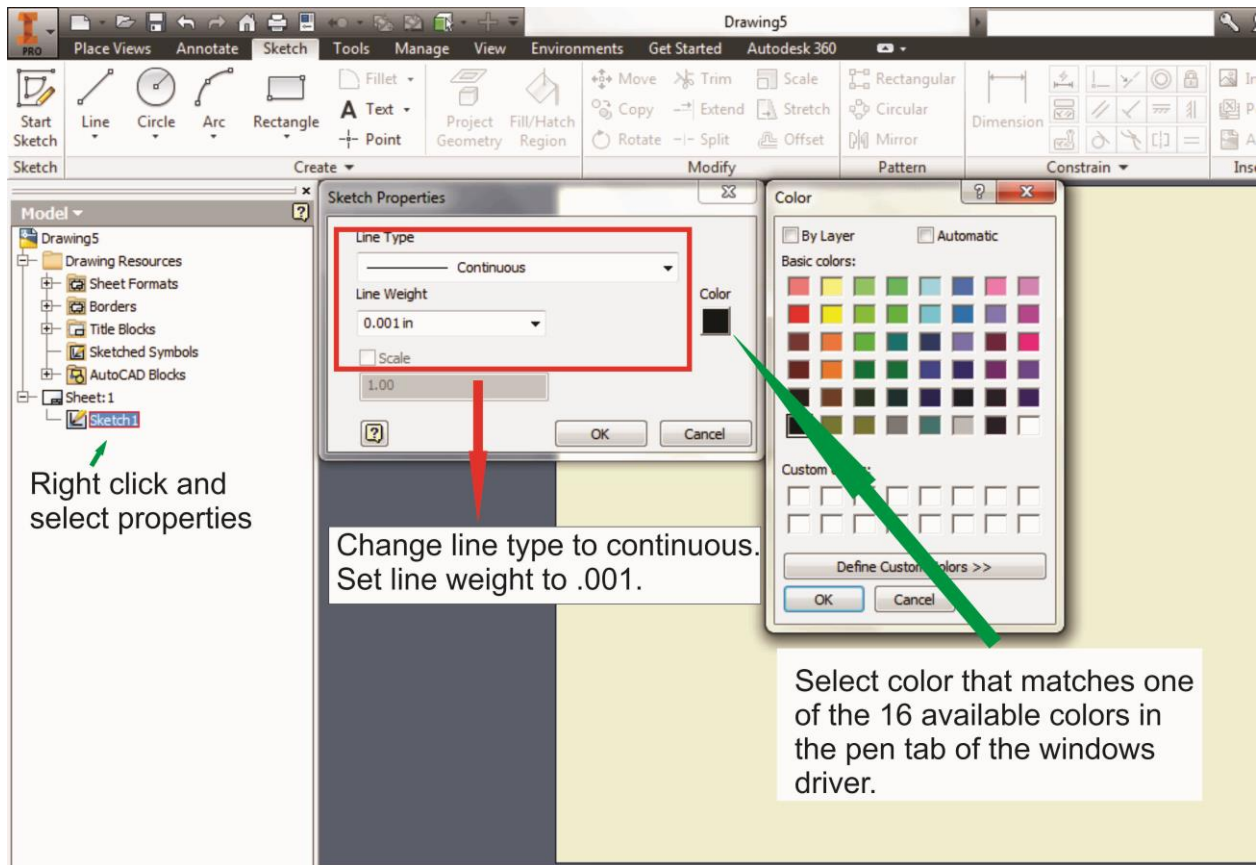

Note: All objects created in one particular sketch will have the same properties meaning all will engrave or all will cut. If you would like to engrave and cut in the same job you will need at least two sketches, one with all the engravings and another with all the cuts, to do so properly.

## 4.7 Using eCUT Plug-in with GCC Lasers

eCut is an inexpensive and powerful plugin work under CorelDRAW or Illustrator software with GCC laser systems. It increases the functions Corel Draw or Illustrators doesn't have or simplifies the operations workflow. eCut details and operation videos can be found on <http://eng.e-cut.ru/>

### eCut unique feature list:

- Nesting
- Puzzles
- Material usage calculation
- AutoText to import files including image, text, QR code, and barcode etc. to the linked variable columns.
- Slice/ Tile function
- CAD editing function
- Sign box and packaging box aided design
- 2D barcode
- QR code

# 5

## Chapter 5

---

# Operating LaserPro Spirit Series

### Using the Hardware

- Laser Key Switch
- Adjusting the LCD Display Screen's Contrast Setting
- Graphic Control Panel Overview (Description)
- Graphic Control Panel Navigation Chart
- Graphic Control Panel Function Pages

### The LaserPro Spirit Series Print Driver

- Page Setup and Orientation
- Color Management
- Using the LaserPro Spirit Series Print Driver
- LaserPro Spirit Series Print Driver >> Options Page
- LaserPro Spirit Series Print Driver >> Pen Page
- Spirit Series Print Driver >> Advanced Page
- Spirit Series Print Driver >> Paper Page
- Spirit Series Print Driver >> Language Page

Once you have installed the LaserPro USB Driver (for use with USB connection), LaserPro Print Driver, and have connected the LaserPro Spirit Series to your computer, you will need to familiarize yourself with the LaserPro Spirit Series control panel and LaserPro Print Driver. The print driver will be where specific laser parameters for your jobs are configured, while the control panel will allow you to set repeat times, manipulate file order, perform auto / manual focusing, and more.

## 5.1 Using the Hardware

### 5.1.1 Laser Key Switch

Turn the key-switch to the “ON” position BEFORE powering on the machine. If the key-switch is turned to the “OFF” position, the laser will be disabled meaning that the laser will not fire although the XY motion system will still move. The laser firing will need 8-10 seconds to warm up if turning to off, and turn on later, therefore, please wait 10 seconds before pressing START button for laser work.

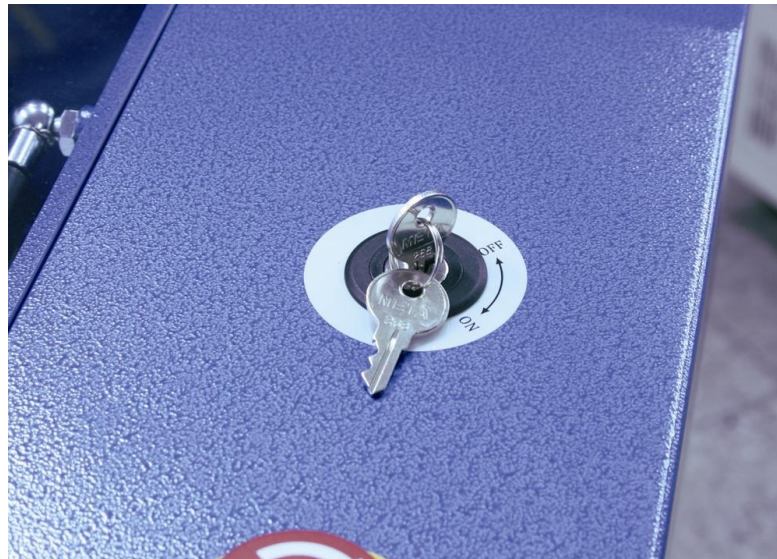

### 5.1.2 Adjusting the LCD Display Screen's Contrast Setting

Depending on the lighting of your immediate work area, you may need to adjust the contrast of LCD display screen. You may increase or decrease the display screen's contrast via the contrast adjustment wheel found on the inside of the front cover on the bottom, right-hand side. You can access this area by opening the top window and looking inside to the rear, right side of the work area (as shown in the picture below).

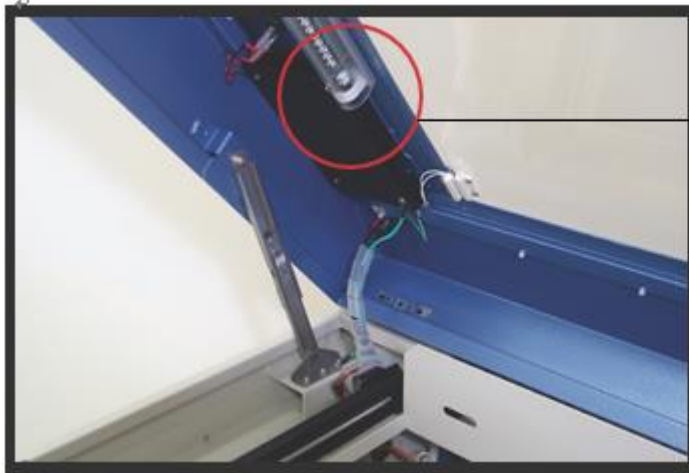

LCD Display Screen's Contrast Adjustment Wheel

### 5.1.3 Graphic Control Panel Overview

#### The Control Panel

The control panel on the LaserPro Spirit Series provides an easy access to all the manual controls needed for cutting and engraving. The liquid crystal display (LCD), functional, directional and selection buttons make navigating through the machine's manual controls easy to do.

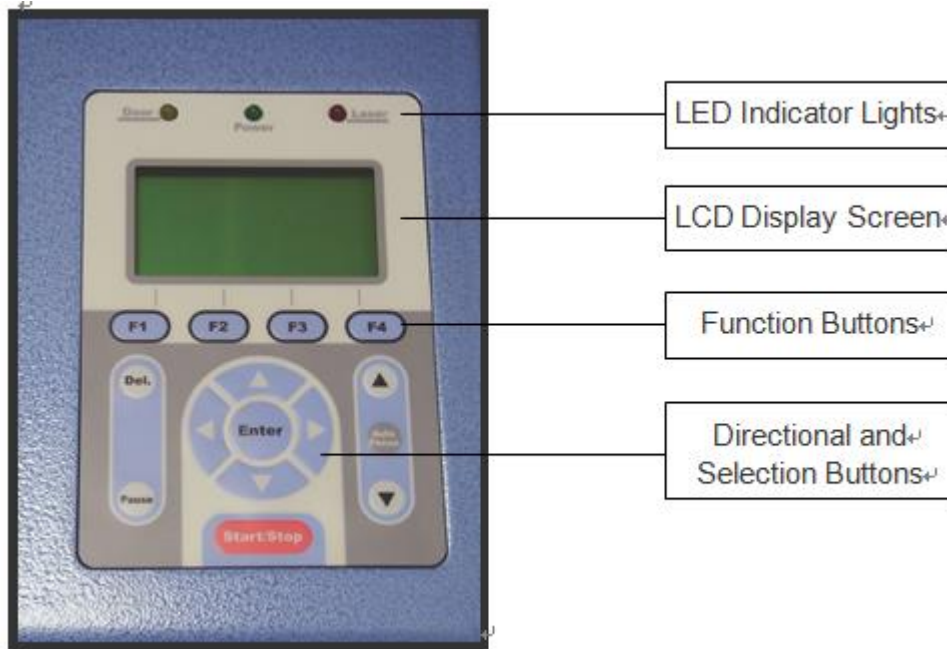

#### LED Indicator Lights

The three indicator lights on the LaserPro Spirit Series control panel are part of the system's safety interlock system.

- Door – The door light will illuminate when either the top lid or external pass through doors on the LaserPro Spirit Series are open or improperly closed.
- Power – The power light will illuminate when the LaserPro Spirit Series is powered on.
- Laser – The laser light will illuminate when the laser is active and in operation.

#### WARNING

- DO NOT attempt to remove or modify any component of the safety interlock system.
- If at any time, any of the access doors are open and the "laser" LED is illuminated, unplug the laser system IMMEDIATELY and contact GCC technical support for service instructions.
- DO NOT operate the laser system if any component of the safety system is malfunctioning.



## Directional and Selection Buttons

**Function (F1 / F2 / F3 / F4)** – Four function buttons allow you to select various functions which will change depending on what section of the menu you are in. Each function button's corresponding task will be displayed right above its respective button on the LCD display screen. Please note that in certain menus, not every function button will always be mapped to a corresponding action. In these situations, that particular button will not have a function.

**Directional ( $\Delta$  /  $\nabla$  /  $\triangleleft$  /  $\triangleright$ )** – Four directional buttons allow you to navigate the selection cursor through the control panel menu and adjust the value of specific settings. In general, the  $\triangleleft$  /  $\triangleright$  directional buttons cycle through the various selections, while the  $\Delta$  /  $\nabla$  directional buttons adjust the value of that particular selection.

**Enter** – Confirms the current selection.

**Start / Stop** – Allows you to start or stop engraving jobs, once those jobs have been successfully loaded onto the system.

**Delete** – Provides quick access to delete the current job.

**Pause** – Pauses the current engraving process. Press again to resume the current process.

**Auto Focus** – After you have positioned your material and moved the lens carriage head to the area you want to engrave, press this button and the system will automatically adjust the optimal vertical focal distance for the laser.

**Manual Focus ( $\blacktriangle$  /  $\blacktriangledown$ )** – To manually adjust the vertical focal distance between the laser head and the material, you can use the  $\blacktriangle$  /  $\blacktriangledown$  buttons to do so. Doing so will adjust the vertical height (z-axis) of the worktable.

### NOTE

There is an 8-second warm up period after the door LED is triggered for systems equipped with Synrad laser tubes. i.e. opening the top lid or the external pass through doors of the machine. Operator must wait for 8 seconds before the laser tube can begin to work.

### 5.1.4 Graphic Control Panel Navigation Chart

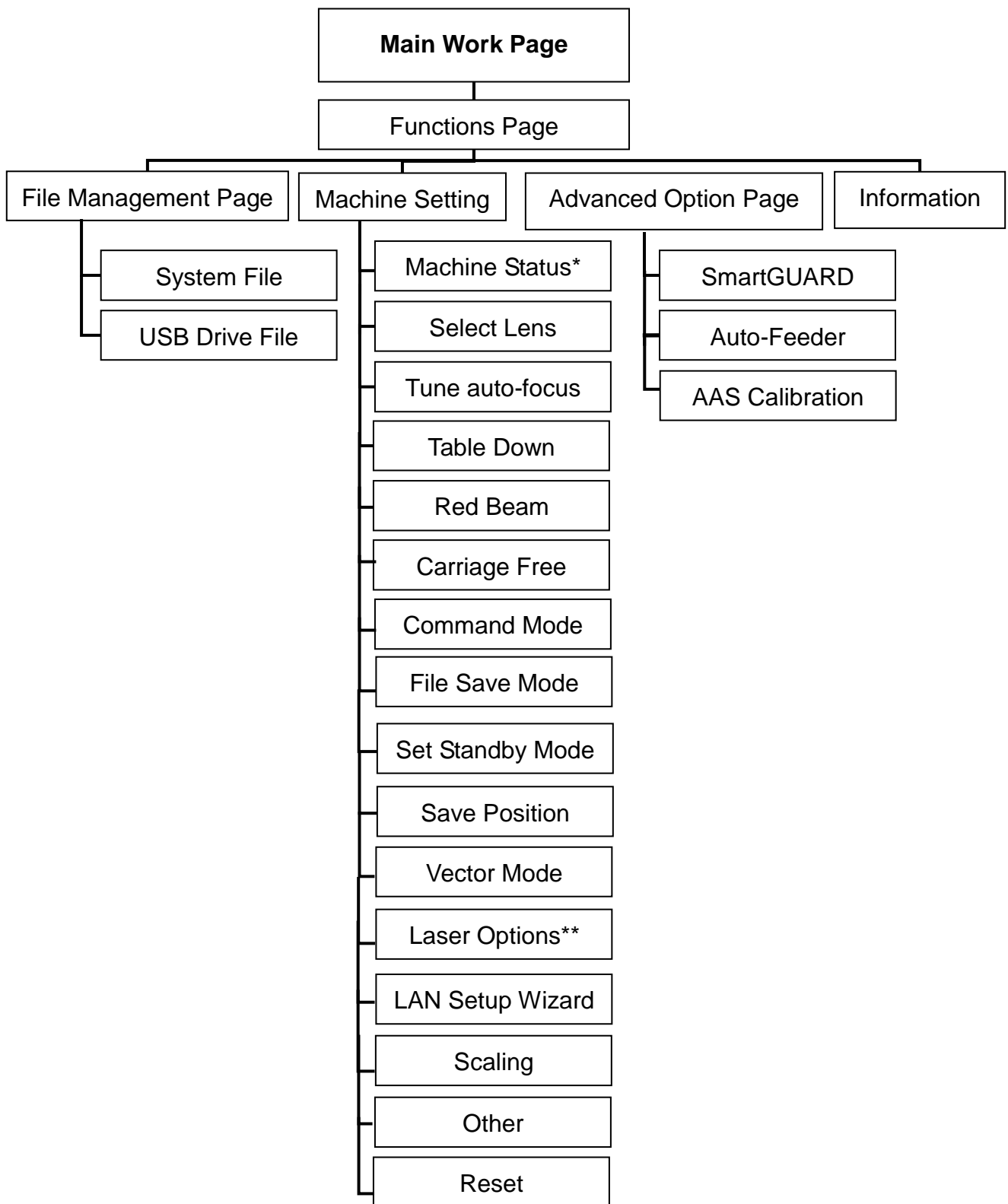

\*For Spirit Series with GT tube installed

\*\*For Spirit GLS Hybrid model with fiber laser installed

### 5.1.5 Graphic Control Panel Function Pages

When the LaserPro Spirit Series is powered on, the machine will perform a series of safety checks and initialization routines. The LCD display screen will display the GCC copyright, LaserPro logo, and machine initialization pages before going to the main work page.

#### Main Work Page

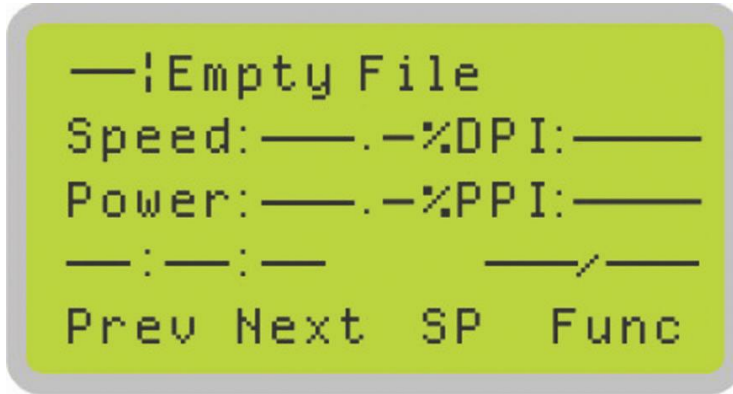

The main work page is the page that the LaserPro Spirit Series will default to upon startup and will be the “home base” for when navigating through the various functions of the control panel. This will be the page that is displayed when you are processing your jobs. This page contains specific job information such as the current job’s name, Speed, Power, PPI, DPI, processing / remaining times, and jobs loaded.

Main Work Page	
Relevant Buttons	Function
F1 (Prev)	Scroll through previous jobs
F2 (Next)	Scroll through next jobs
F3 (SP)	Go to Store Position Page for SmartCENTER function
F4 (Func)	Go to Functions Page
△ / ▽ / ◀ / ▶ Directional	Go to Carriage / Work Table Adjustment Page
Start / Stop	Start / Stop the current job
Delete	Delete the current selected job
Auto Focus	Initiate the auto focus function
▲ / ▼ Manual Focus Buttons	Manually adjust the height of the work table (Z-axis)

## Carriage / Work Table Adjustment Page

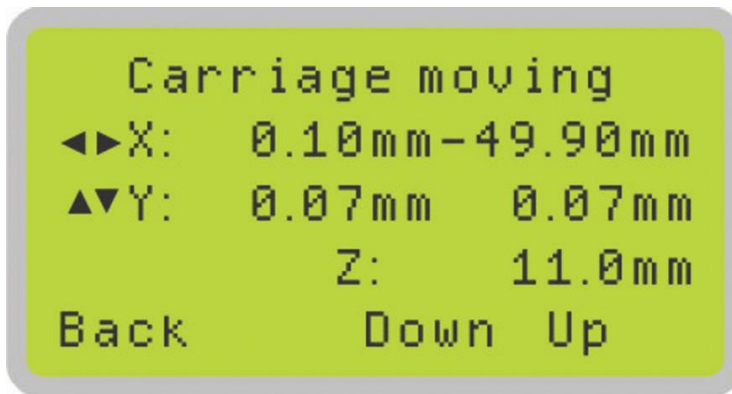

**i** Navigating to this page:

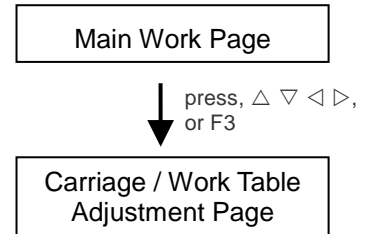

The Carriage / Work Table Adjustment Page allow you to manually increase and decrease the height of the work table (Z-axis). In addition, you can manually adjust the Y-axis and X-axis of the lens carriage.

Carriage / Work Table Adjustment Page	
Relevant Buttons	Function
F1 (Back)	Back to previous page
F3 (Down)	Manually decrease the height of the work table (Z-axis)
F4 (Up)	Manually increase the height of the work table (Z-axis)
Δ / ∇ / ◀ / ▶ Directional	Manually adjust the Y-axis position of the lens carriage
◀ / ▶ Directional	Manually adjust the X-axis position of the lens carriage
Start / Stop	Start / Stop the current job
Auto Focus	Initiate the auto focus function
▲ / ▼ Manual Focus Buttons	Manually adjust the height of the work table (Z-axis)

## SmartCENTER Page

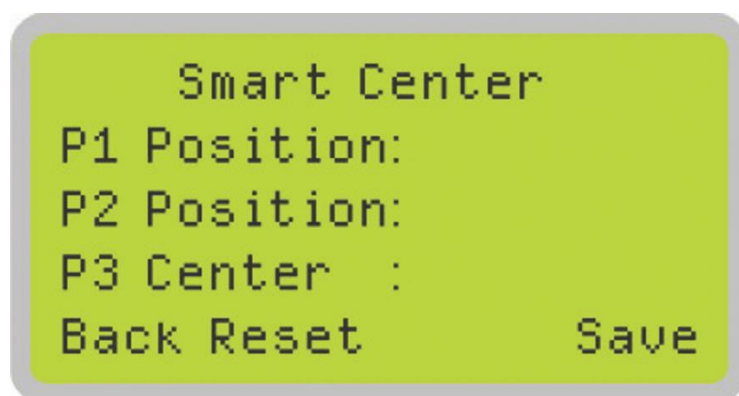

**i** Navigating to this page:

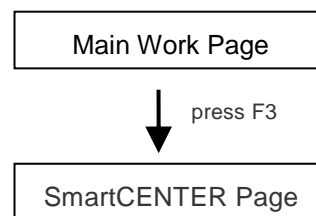

Under SmartCENTER mode the job will begin after the system positions the carriage to the center position between two points or four points indicated by the user. The SmartCENTER mode has to be enabled through the driver.

Enter SmartCENTER page by pressing the <F3> button. You will be prompted to indicate and store the position points. The positions can be indicated by moving the carriage by hand and pressing enter to save the positions indicated by the red pointer. After all points are set, the carriage will move to the center of the stored positions and the job will begin.

SmartCENTER Page	
Relevant Buttons	Function
F1 (Back)	Back to previous page
F2 (Reset)	Reset all saved positions
F4 (Save)	Save current lens carriage position
Auto Focus	Initiate the auto focus function
▲ / ▼ Manual Focus Buttons	Manually adjust the height of the work table (Z-axis)

## Functions Page

The Functions Page allows you to edit file management and machine settings. From this page, you will be able to access the File Management, Machine Setting, and Machine Information pages.

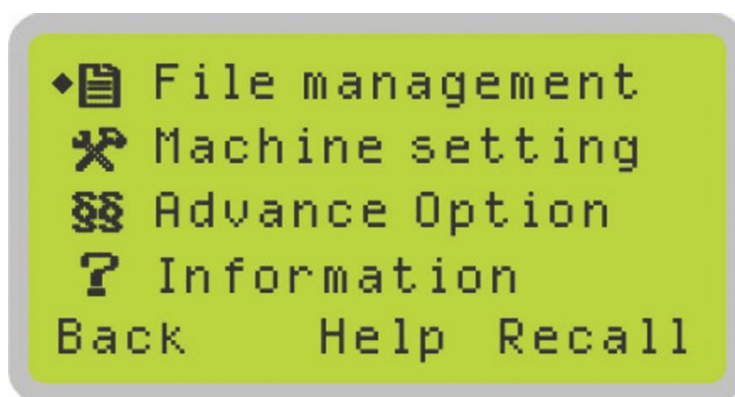

**i** Navigating to this page:

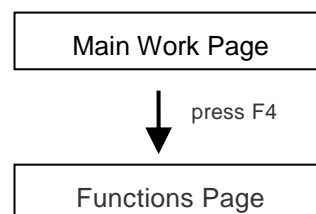

- File Management Page – this page allows you to manage the files that you have loaded onto the LaserPro Spirit Series.
- Machine Setting Page – this page allows you to access and modify various machine settings, including: Set Lens, Tune Auto Focus, Set Table Down, Set Red Beam, Carriage Lock, Set Command Mode, Set File Save Mode, Set Vector Mode, LAN Setup, Other, Reset.
- Advanced Option Page- this page allows you to enable different optional peripherals for the laser machine, such as roll to roll auto-feeder, AAS calibration for contour cutting, SmartGUARD fire alarm etc.
- Machine Information Page – this page allows you to view information regarding the system such as the GCC logo, machine name, firmware version, and other information.

Functions Page	
Relevant Buttons	Function
F1 (Back)	Back to previous page
F3 (Help)	Display help
F4 (Recall)*	Recall the saved position as origin for subsequent jobs
△ / ▽ Directional	Scroll through the menu selections
Enter	Perform the selection
Start / Stop	Back to Main Work Page
Auto Focus	Initiate the auto focus function
▲ / ▼ Manual Focus Buttons	Manually adjust the height of the work table (Z-axis)

\*refers to Machine Setting Page for save position and recall position functions.

## File Management Page

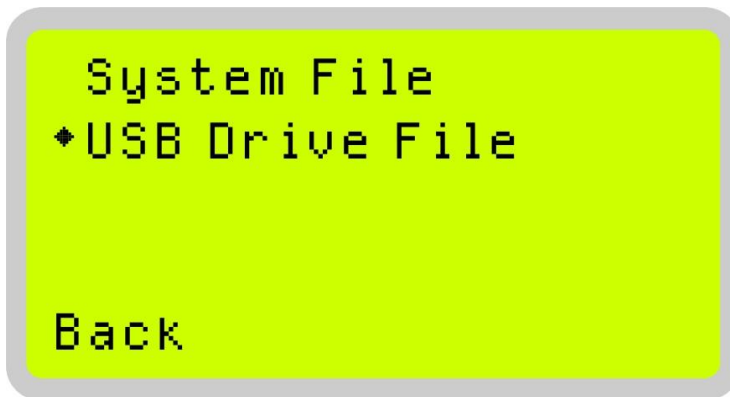

**i** Navigating to this page:

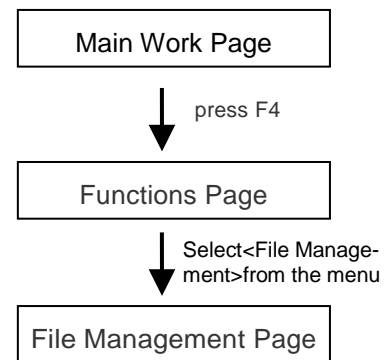

The File Management Page allows you to manage the files from system or USB drive.

File Management Page	
Relevant Buttons	Function
F1 (Back)	Back to previous page
△ / ▽ Directional	Scroll through the menu selections
Enter	Perform the selection
Start / Stop	Back to Main Work Page
Auto Focus	Initiate the auto focus function
▲ / ▼ Manual Focus Buttons	Manually adjust the height of the work table (Z-axis)

## System File Page

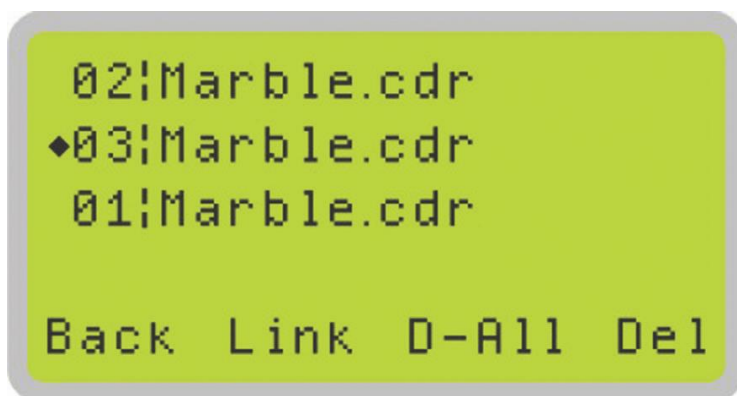

**i** Navigating to this page:

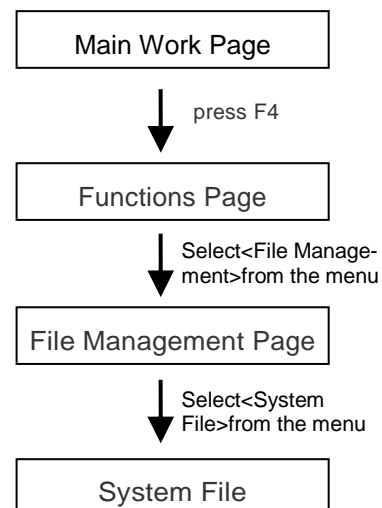

The System File Page allows you to manage the files that you have loaded onto the LaserPro Spirit Series. You can scroll through your jobs, delete a selected job, delete all jobs, and go to the Link / DLink Page to set and arrange multiple loaded jobs into a single job queue for processing.

System File Page	
Relevant Buttons	Function
F1 (Back)	Back to previous page
F2 (Link)	Display help
F3 (D-All)	Back to previous page
F4 (Del)	Delete the selected job
△ / ▽ Directional	Scroll through the menu selections
Enter	Perform the selection
Start / Stop	Back to Main Work Page
Auto Focus	Initiate the auto focus function
▲ / ▼ Manual Focus Buttons	Manually adjust the height of the work table (Z-axis)



## USB Drive File Page

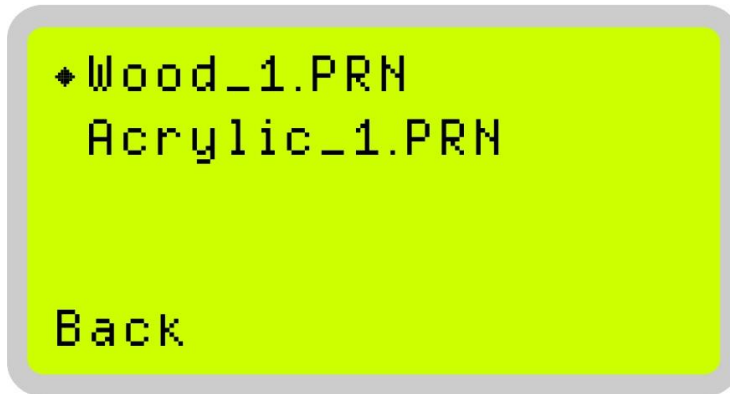

**i** Navigating to this page:

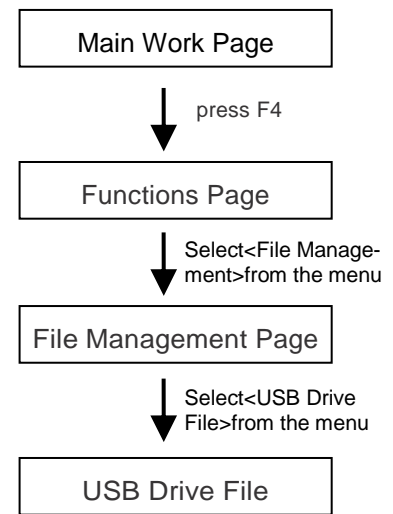

The USB Drive File Page allows you to load file from USB storage. You can scroll through your job to processing.

USB Drive File Page	
Relevant Buttons	Function
F1 (Back)	Back to previous page
△ / ▽ Directional	Scroll through the menu selections
Enter	Perform the selection
Start / Stop	Back to Main Work Page
Auto Focus	Initiate the auto focus function
▲ / ▼ Manual Focus Buttons	Manually adjust the height of the work table (Z-axis)

## Link / DLink Page

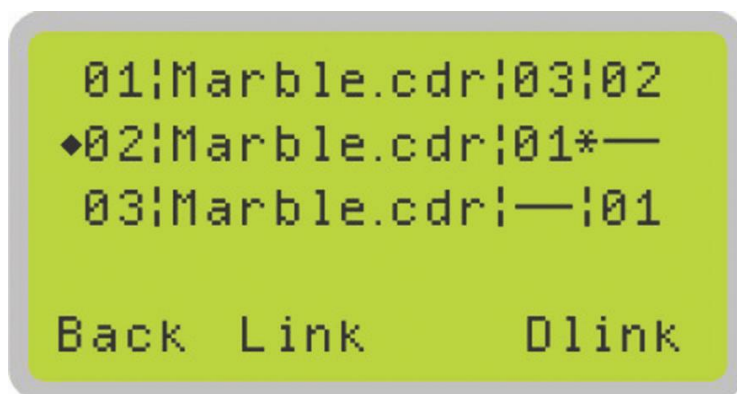

**i** Navigating to this page:

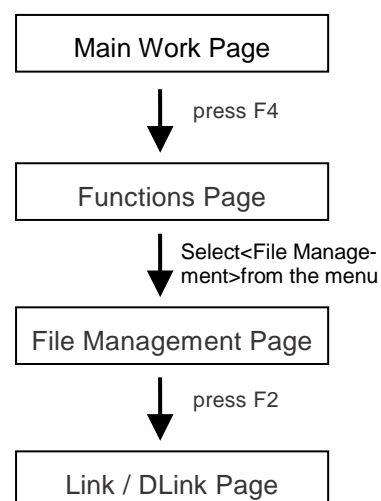

The Link / DLink Page allows you to set, arrange, and remove loaded jobs to and from a job queue for processing. Use the directional keys to cycle through your loaded jobs, then simply press the <F2 (Link)> key to add a file to the job queue. The job queue will be set in a sequential order based on the order you link the files. To remove a job from your job queue, press the <F4 (DLink)> key.

The first column field (before the file name) displays the job number. The sequence for your job queue is displayed in the two columns to the right of your file names. The first column to the right of your job file name displays the job number of the previous file in the job queue sequence. The second column after the file name displays that job's next file in the job queue sequence. First and last jobs in the job sequence you set will have a (---) in the first and second columns respectively. So according to the image above, the job queue sequence has been set to be processed in this order: 03:Marble.cdr → 01:Marble.cdr → 02:Marble.cdr.

Link / DLink Page	
Relevant Buttons	Function
F1 (Back)	Back to previous page
F2 (Link)	Add the currently-selected job to the job queue
F4 (DLink)	Remove the currently-selected job from the job queue
△ / ▽ Directional	Scroll through the menu selections
Start / Stop	Back to Main Work Page
Auto Focus	Initiate the auto focus function
▲ / ▼ Manual Focus Buttons	Manually adjust the height of the work table (Z-axis)

## File Information Page

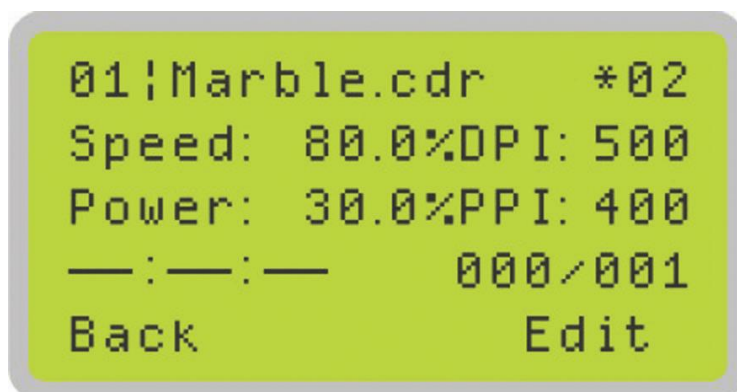

**i** Navigating to this page:

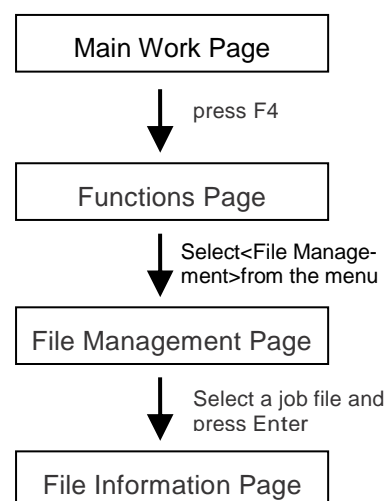

The File Information Page allows you to view the speed, power, DPI, and PPI settings of the selected job. In addition, you will be able to go to the File Management Edit Page from this menu to change raster/ vector speed and power settings for the selected job.

File Information Page	
Relevant Buttons	Function
F1 (Back)	Back to previous page
F4 (Edit)	Go to the File Management Edit Page for the selected job
Start / Stop	Back to Main Work Page
Auto Focus	Initiate the auto focus function
▲ / ▼ Manual Focus Buttons	Manually adjust the height of the work table (Z-axis)

## File Management Edit Page

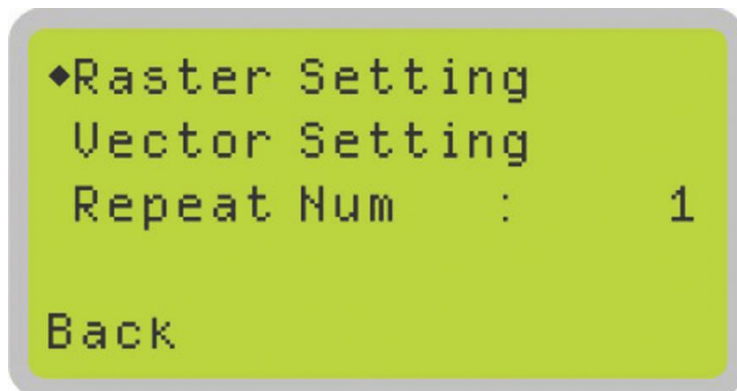

**i** Navigating to this page:

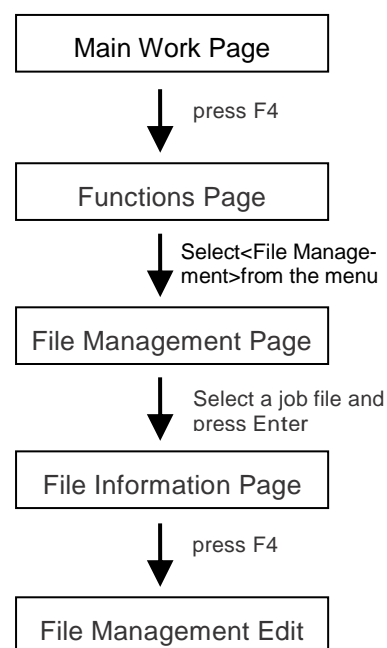

The File Management Edit Page allows you the choice to modify your raster or vector settings for the selected job, as well as setting the number of times to repeat the process of the selected job (Repeat Num).

File Management Edit Page	
Relevant Buttons	Function
F1 (Back)	Back to previous page
△ / ▽ Directional	Scroll through your loaded jobs
◀ / ▶ Directional	Cycle through the available selections
Enter	Perform the selection
Start / Stop	Back to Main Work Page
Auto Focus	Initiate the auto focus function
▲ / ▼ Manual Focus Buttons	Manually adjust the height of the work table (Z-axis)

## File Edit Raster Page

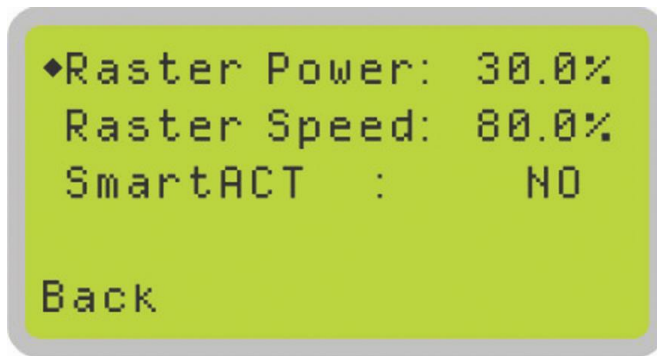

**i** Navigating to this page:

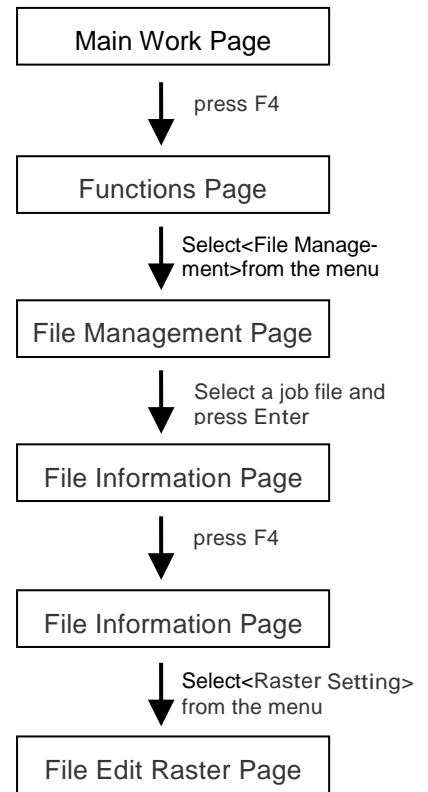

The File Edit Raster Page allows you to edit the raster power and speed settings, as well as enable or disable SmartACT for the selected job. These settings correspond to the same settings found on the LaserPro Spirit series print driver. This page allows you to easily adjust these values to make immediate adjustments while processing your loaded jobs, even when you have disconnected your computer from the LaserPro Spirit series.

- Raster Power: 0.0% - 100%
- Raster Speed: 0.0% - 100%
- SmartACT: YES/ NO

File Edit Raster Page	
Relevant Buttons	Function
F1 (Back)	Back to previous page
△ / ▽ Directional	Scroll through your loaded jobs
◀ / ▶ Directional	Cycle through the available selections
Start / Stop	Back to Main Work Page
Auto Focus	Initiate the auto focus function
▲ / ▼ Manual Focus Buttons	Manually adjust the height of the work table (Z-axis)

## File Edit Vector Page

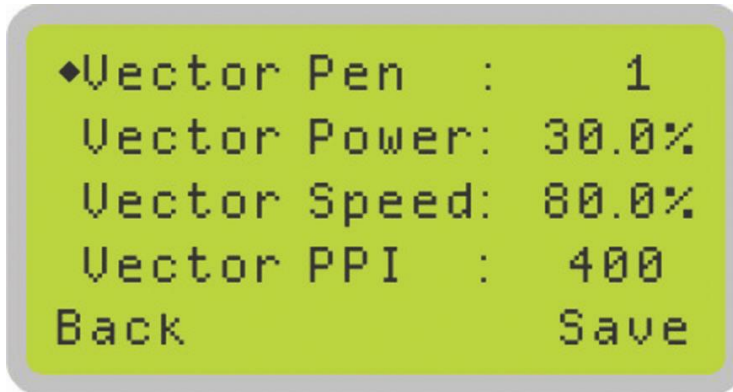

**i** Navigating to this page:

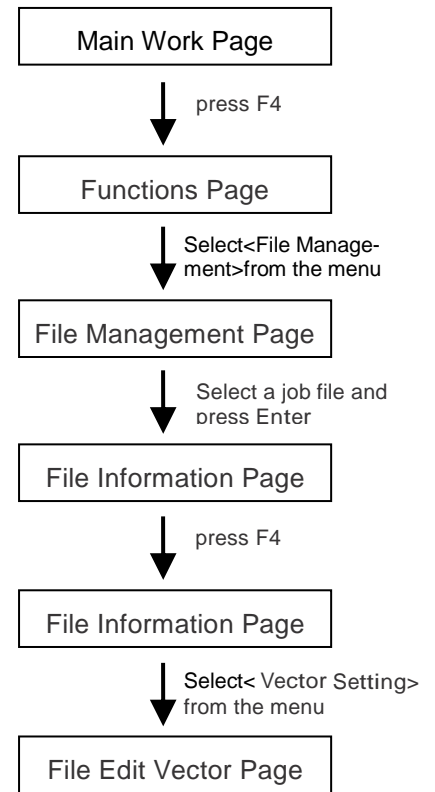

The File Edit Vector Page allows you to edit the vector pen, vector power, vector speed, and vector PPI, and power ramp settings for the selected job. These settings correspond to the same settings found on the LaserPro Spirit Series print driver. This page allows you to easily adjust these values to make immediate adjustments while processing your loaded jobs, even when you have disconnected your computer from the LaserPro Spirit Series.

- Vector Pen: 1 - 16
- Vector Power: 0.0% - 100%
- Vector Speed: 0.0% - 100%
- Vector PPI: 30 - 1524
- Power Ramp: YES/ NO

File CoreIDRAW Vector Page	
Relevant Buttons	Function
F1 (Back)	Back to previous page
F4 (Save)	Save your current settings
△ / ▽ Directional	Scroll through your loaded jobs
◀ / ▶ Directional	Adjust the value for that selection
Start / Stop	Back to Main Work Page
Auto Focus	Initiate the auto focus function
▲ / ▼ Manual Focus Buttons	Manually adjust the height of the work table (Z-axis)

## Machine Setting Page

◆Select Lens  
Tune auto-focus  
Table Down  
Red Beam  
Back            Next   Prev

Carriage Free  
Command Mode  
File Save Mode  
◆Set Standby Mode  
Back            Next Prev

Save Position  
Vector Mode  
Laser Options  
LAN Setup Wizard  
Back            Next Prev

Scaling  
Others  
Resep  
Back            Next Prev

 Navigating to this page:

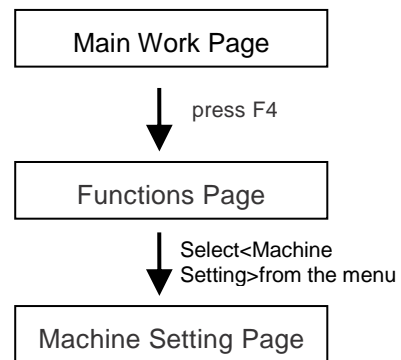

The Machine Setting Page allows you to access and modify various machine settings, including: Set Lens, Tune Auto Focus, Set Table Down, Red Beam on/ off, Carriage Free, select Command Mode, File Save, Select Vector Mode, LAN setup, Other, and Reset etc.

## Machine Setting Page

Relevant Buttons	Function
F1 (Back)	Back to previous page
F3 (Next)	Scroll to next page
F4 (Prev)	Scroll to previous page
△ / ▽ Directional	Scroll through your loaded jobs
Enter	Perform the selection
Start / Stop	Back to Main Work Page
Auto Focus	Initiate the auto focus function
▲ / ▼ Manual Focus Buttons	Manually adjust the height of the work table (Z-axis)



## Machine Setting- Machine Status (GT Tube only)

**i** Navigating to this page:

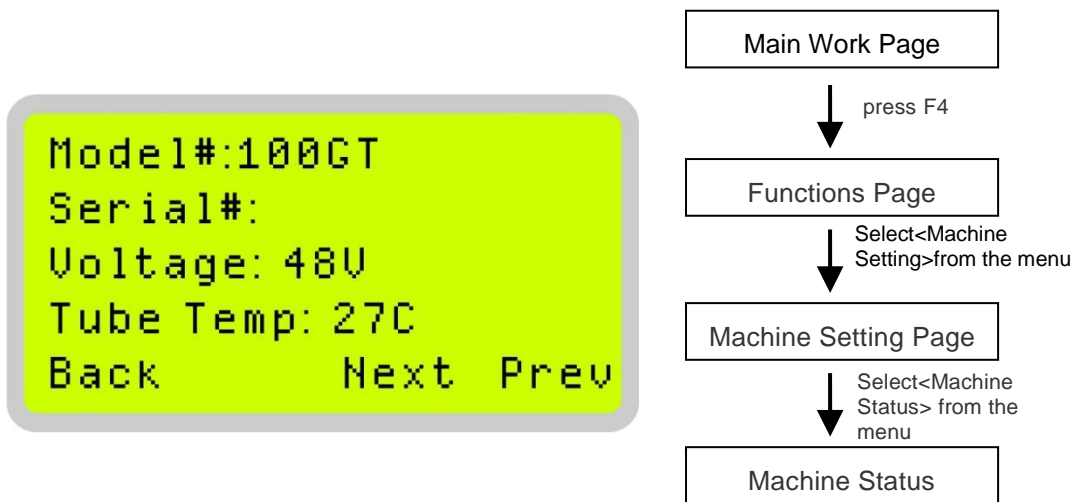

Machine Status Page allows user to check the status of the machine and laser tube via control panel in real time.

System will show the laser warning message on the control panel to remind users when the voltage or temperature is abnormal.

Laser tube over voltage. Please turn off the power and check the voltage of the power supply.

Laser tube over temperature. Please turn off the power and check the cooling system.

Set Lens Page	
Relevant Buttons	Function
F1 (Back)	Back to previous page

## Machine Setting- Select Lens Page

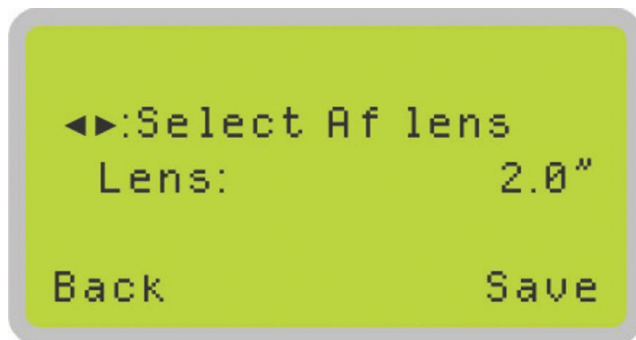

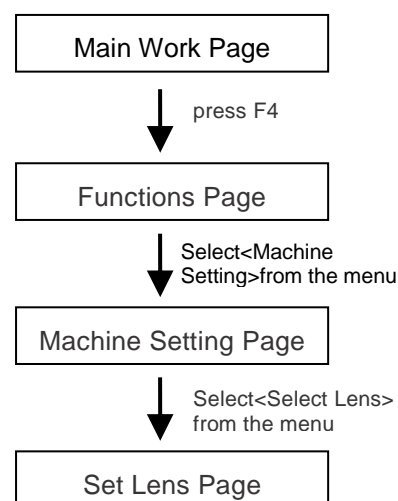

**i** Navigating to this page:





The Select Lens Page allows you to modify the lens settings after you have changed to a different focal lens. Remember to save your settings after you have made the proper changes. After that, pressing the Auto Focus button on control panel, the laser machine will conduct auto focus accordingly using the new lens setting.

GCC LaserPro Spirit series machine include different models which equipped different laser tubes, make sure the laser tubes installed with your machine before making adjustment.

- CO2 Laser Focal Lens: 1.5" / 2.0" / 2.5" / 4.0" (Default 2.0")

 Lens	1.5"	2.0"	2.5"	4.0"
 Spot Size	0.0029" (0.073mm)	0.0039" (0.099mm)	0.0048" (0.121mm)	0.0078" (0.198mm)

- Fiber Laser Focal Lens: 2.0" / 4.0" (Default 4.0") with F75 beam expander

 Lens	2.0"	4.0"
 Spot Size	0.0005" (0.0129mm)	0.001" (0.0258mm)

- CO2+Fiber Hybrid Laser Focal Lens: 2.0" with F30 beam expander

 Lens	2.0"	2.0"
 Spot Size	0.0039" (0.099mm)	0.0011" (0.0297mm)
Laser Type	CO2 Laser	Fiber Laser

Go to Chapter 7.3 for different lens detailed information.

## Set Lens Page

Relevant Buttons	Function
F1 (Back)	Back to previous page
F4 (Save)	Save your current settings
△ / ▽ Directional	Cycle through selections
Start / Stop	Back to Main Work Page
Auto Focus	Initiate the auto focus function
▲ / ▼ Manual Focus Buttons	Manually adjust the height of the work table (Z-axis)

## Machine Setting- Tune Auto Focus Page

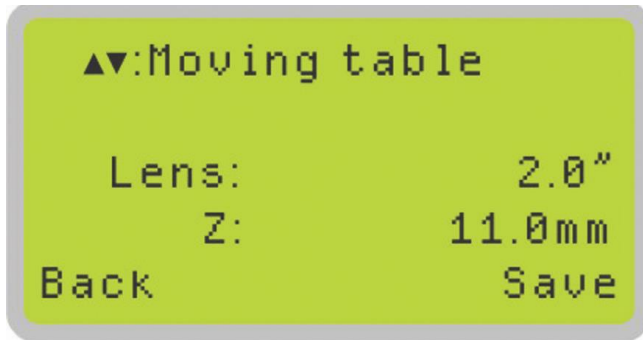
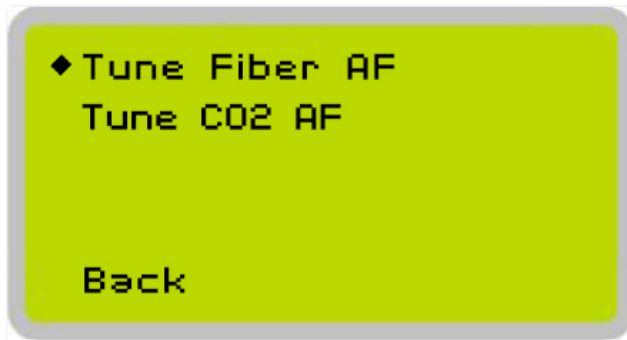

**i** Navigating to this page:

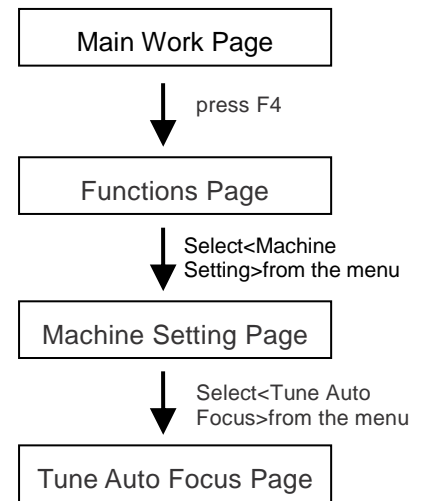

The Tune Auto Focus Page allows you to manually adjust the auto focus default value, or distance from lens carriage to the worktable (Z-axis) when the Auto Focus button is pressed.

GCC LaserPro Spirit series machine include different models which equipped different laser tubes, make sure the laser tubes installed with your machine before making adjustment.

Tune Auto Focus Page	
Relevant Buttons	Function
F1 (Back)	Back to previous page
F4 (Save)	Save your current settings
△ / ▽ Directional	Manually adjust the height of the work table (Z-axis)
Start / Stop	Back to Main Work Page
Auto Focus	Initiate the auto focus function
▲ / ▼ Manual Focus Buttons	Manually adjust the height of the work table (Z-axis)

## Machine Setting- Table Down Page

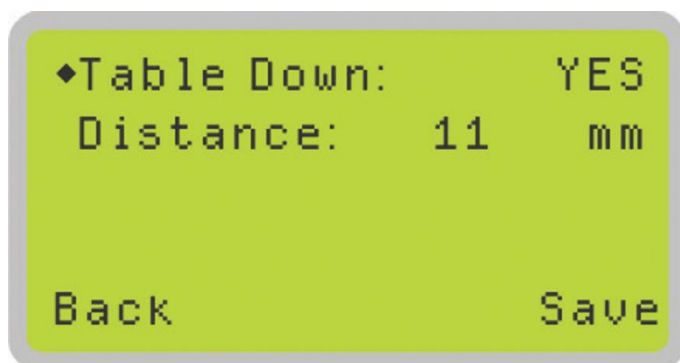

**i** Navigating to this page:

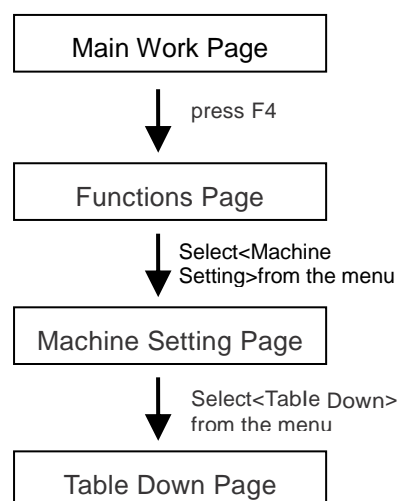

The Set Table Down Page allows you to select whether or not the LaserPro Spirit Series displays a table moving down warning message at startup. If the Table Down selection is set to <YES>, the LaserPro Spirit Series will display a warning message at startup stating: “Table will move down and remove objects on table”. Pressing the Enter key at this point will confirm the prompt to move the work table to its lowest position. If the Table Down is set to <NO>, the LaserPro Spirit Series will not display the warning message at system startup.

- Table Down: YES/ NO
- Distance: 0 - 165 mm (165mm for Spirit, Spirit LS models, and 177mm for Spirit GLS Hybrid model)

Table Down Page	
Relevant Buttons	Function
F1 (Back)	Back to previous page
F4 (Save)	Save your current settings
△ / ▽ Directional	Scroll through the menu selections
◀ / ▶ Directional	Adjust the value for that selection
Start / Stop	Back to Main Work Page
Auto Focus	Initiate the auto focus function
▲ / ▼ Manual Focus Buttons	Manually adjust the height of the work table (Z-axis)

## Machine Setting- Red Beam Page

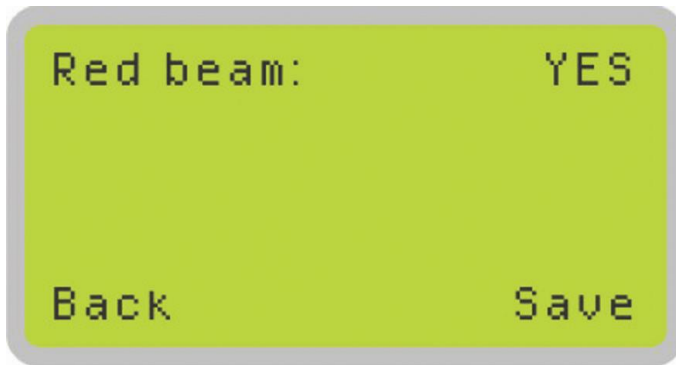

**i** Navigating to this page:

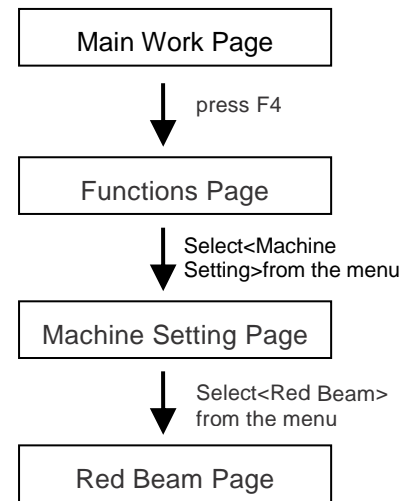

The Red Beam Page allows you to turn on or off the red dot laser pointer on the lens carriage. Enabling this function will indicate the exact area the engraving laser will fire upon.

- Red Beam YES / NO

Red Beam Page	
Relevant Buttons	Function
F1 (Back)	Back to previous page
F4 (Save)	Save your current settings
◀ / ▶ Directional	Cycle Red Beam between YES / NO
Start / Stop	Back to Main Work Page
Auto Focus	Initiate the auto focus function
▲ / ▼ Manual Focus Buttons	Manually adjust the height of the work table (Z-axis)

## Machine Setting- Carriage Free Page

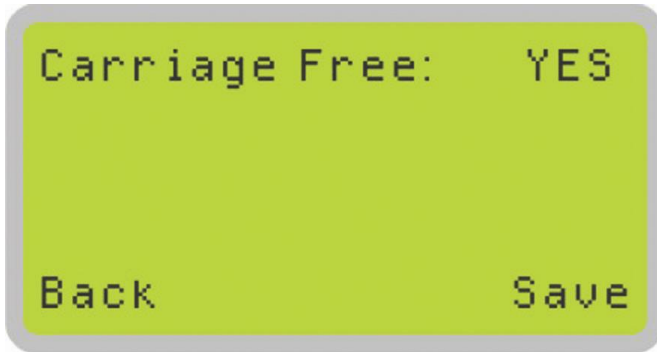

**i** Navigating to this page:

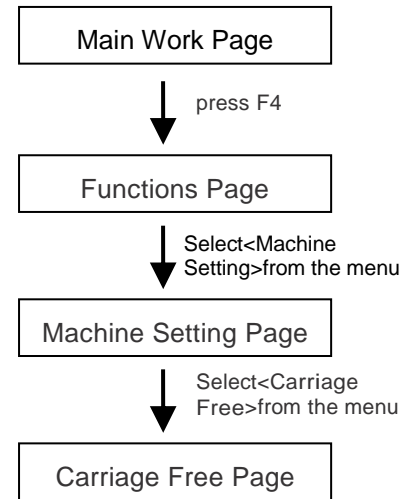

The Carriage Free Page allows you to decide whether the lens carriage to be locked or free for hand movement. If the Carriage Free setting is set to <YES>, then you will be able to manually move the lens carriage along the X and Y axis by hand with the top door open. Whereas setting the Carriage Free to <NO> will lock the lens carriage and movement or positioning can only be done by the control panel arrow keys.

- Carriage Free YES / NO

Carriage Free Page	
Relevant Buttons	Function
F1 (Back)	Back to previous page
F4 (Save)	Save your current settings
◀ / ▶ Directional	Cycle Red Beam between Back / Save
Start / Stop	Back to Main Work Page
Auto Focus	Initiate the auto focus function
▲ / ▼ Manual Focus Buttons	Manually adjust the height of the work table (Z-axis)

## Machine Setting- Command Mode Page

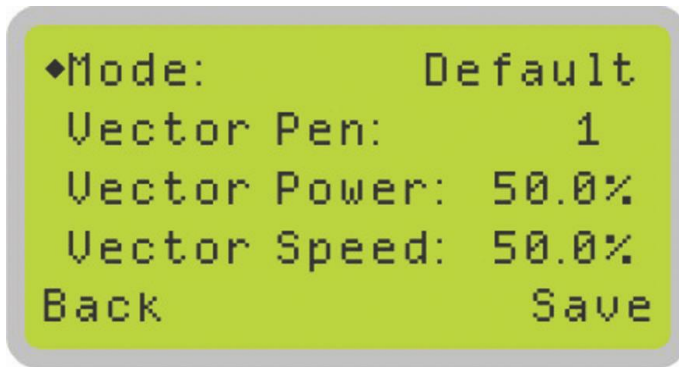

**i** Navigating to this page:

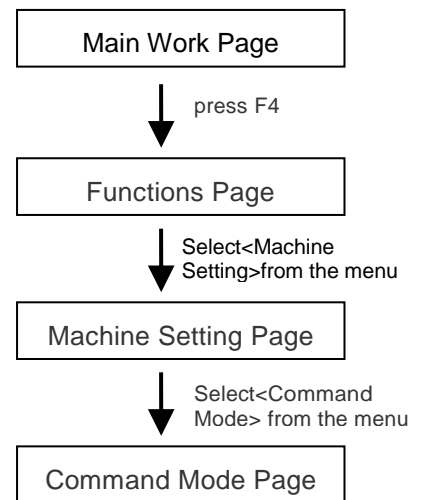

The Command Mode Page allows you to configure vector settings when outputting in Default or HPGL mode. Default mode refers to output the file through standard Windows print driver and also recognized by the most popular graphic software programs such as CorelDRAW, Photoshop, Illustrator, and more. Whereas, HPGL mode is a less common output format generated from some RIP applications (signage industry). Regardless of which format you will be working with, both output formats are supported.

- Mode: Default / HPGL
- Vector Pen: 1 - 16
- Vector Speed: 0.0% - 100%
- Vector PPI: 0.0% - 100%
- Power Ramp: YES / NO

Command Mode Page	
Relevant Buttons	Function
F1 (Back)	Back to previous page
F4 (Save)	Save your current settings
△ / ▽ Directional	Scroll through the menu selections
◀ / ▶ Directional	Adjust the value for that selection
Start / Stop	Back to Main Work Page
Auto Focus	Initiate the auto focus function
▲ / ▼ Manual Focus Buttons	Manually adjust the height of the work table (Z-axis)



## Machine Setting- File Save Mode Page

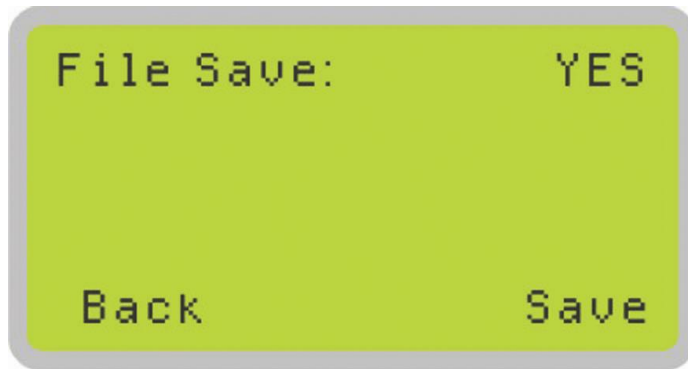

**i** Navigating to this page:

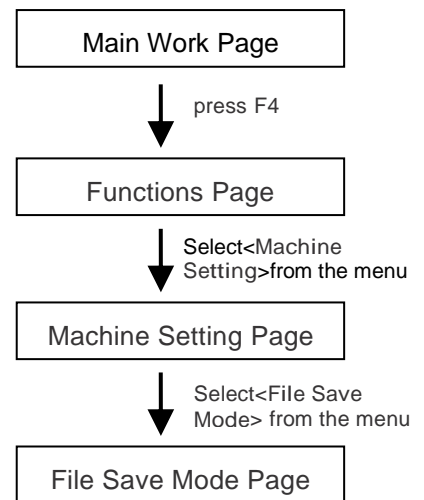

The File Save Mode Page allows you to set whether or not the LaserPro Spirit Series automatically deletes each job file after processing. Setting File Save to <NO> will automatically and immediately delete each job file from the LaserPro Spirit Series after the engraving or cutting process. Setting File Save to <YES> will retain the job files on the LaserPro Spirit Series.

- File Save: YES / NO

File Save Mode Page	
Relevant Buttons	Function
F1 (Back)	Back to previous page
F4 (Save)	Save your current settings
◀ / ▶ Directional	Cycle File Save between YES / NO
Start / Stop	Back to Main Work Page
Auto Focus	Initiate the auto focus function
▲ / ▼ Manual Focus Buttons	Manually adjust the height of the work table (Z-axis)

## Machine Setting- Set Standby Mode Page

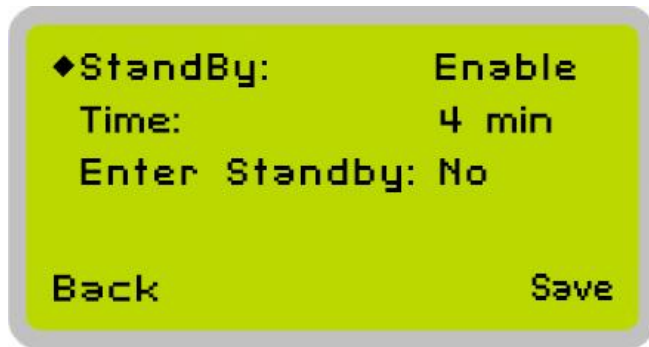

**i** Navigating to this page:

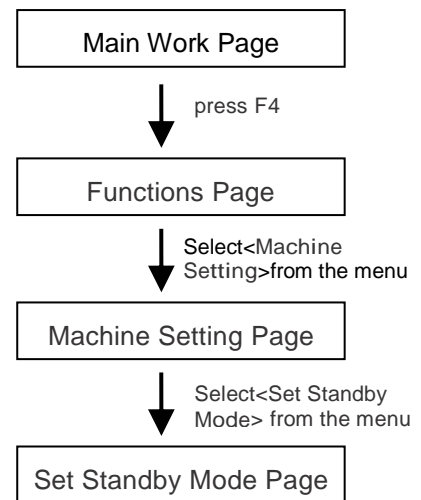

The Set Standby Mode page allows you to configure the laser machine automatically enter into power saving if machine is idle for a specified time.

When entering into the Set Standby Mode function, you can use Left or Right arrow keys to scroll between <Enable> or <Disable> the function. The Time function is to determine after how long the laser machine is idle, it will enter in power saving automatically. The default time is 4 minutes. The Enter Standby function will turn the machine into power saving immediately after selected.

- Standby: Enable/ Disable
- Time: 4-30 mins. (Default 4 mins.)
- Enter Standby: YES/ NO

Set Standby Mode Page	
Relevant Buttons	Function
F1 (Back)	Back to previous page
F4 (Save)	Save your current settings
◀ / ▶ Directional	Cycle standby mode between YES / NO
Start / Stop	Back to Main Work Page
Auto Focus	Initiate the auto focus function
△ / ▽ Directional	Scroll between menu options
▲ / ▼ Manual Focus Buttons	Manually adjust the height of the work table (Z-axis)

## Machine Setting- Save Position Page

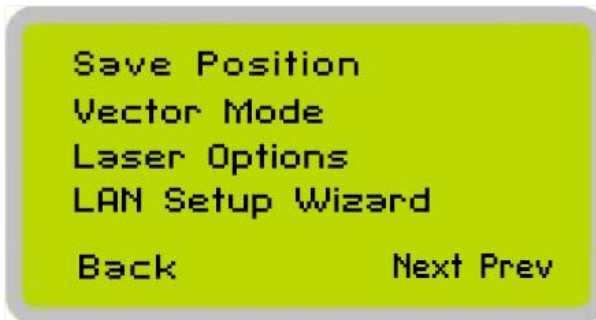

**(i)** Navigating to this page:

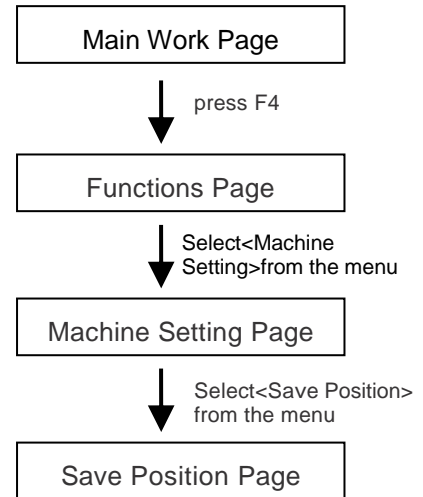

The Save Position Function allows you to save the current X-axis and Y-axis positions of the lens carriage to be the origin for subsequent jobs.



### Tip

.....  
 This is an excellent function to use when you are processing identical items or engraving relatively smaller objects positioned away from the default start position (top left) of the work table.

## Recall Position

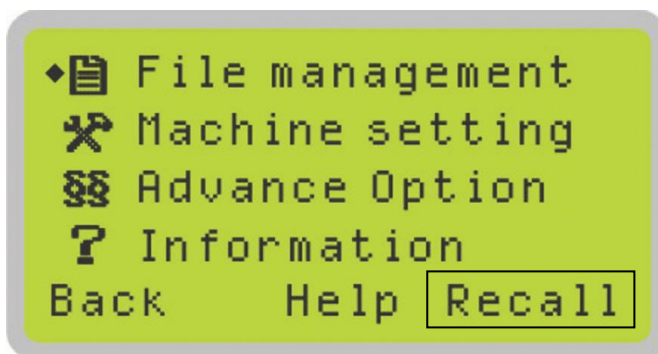

**(i)** Navigating to this page:

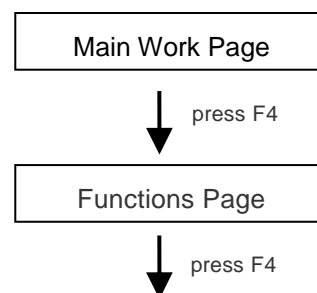

To recall the saved position, simply go to Functions page and press F4 again to recall the saved position. The lens carriage will be moved to the saved position and start subsequent jobs from this origin.

## Machine Setting- Vector Mode Page

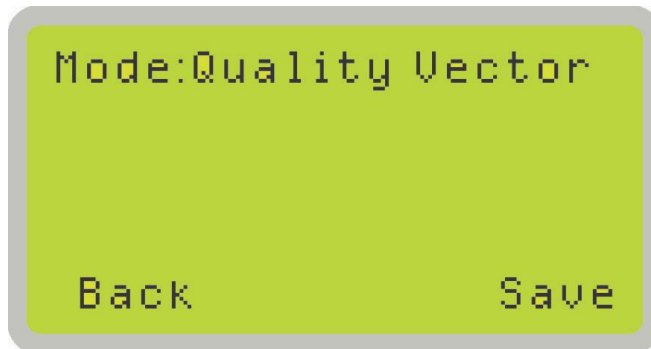

**i** Navigating to this page:

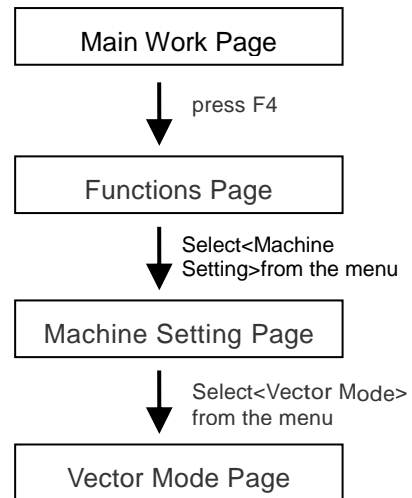

The Vector Mode Page allows you to adjust and balance vector mode's quality and speed settings based on your specific job. Speedy Vector Mode offers the highest output speed, sacrificing quality. Whereas Quality Vector Mode offers the highest quality, sacrificing output speed. Keep in mind that speed and quality are usually at a tradeoff. The system's default is Production Vector mode.

- Modes: Quality, Production, Speedy  
[Slower speeds / higher quality ----- Faster speeds / lower quality]

The machine will reboot automatically after clicking <Save> button for the change.

Vector Mode Page	
Relevant Buttons	Function
F1 (Back)	Back to previous page
F4 (Save)	Save your current settings
◀ / ▶ Directional	Cycle Set Vector Mode between QUALITY/ FINE/ COARSE/ SPEEDY VECTOR
△ / ▽ Directional	Scroll through menu options
Start / Stop	Back to Main Work Page
Auto Focus	Initiate the auto focus function
▲ / ▼ Manual Focus Buttons	Manually adjust the height of the work table (Z-axis)

## Machine Setting- Laser Options Page

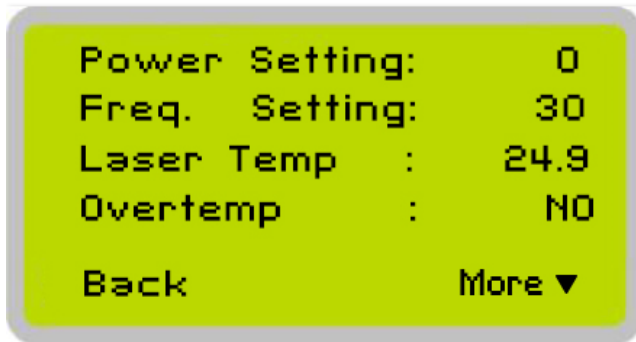
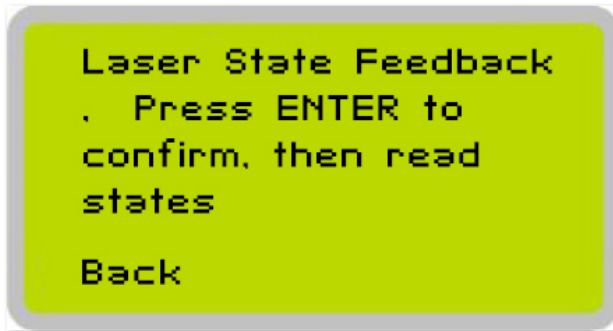

**i** Navigating to this page:

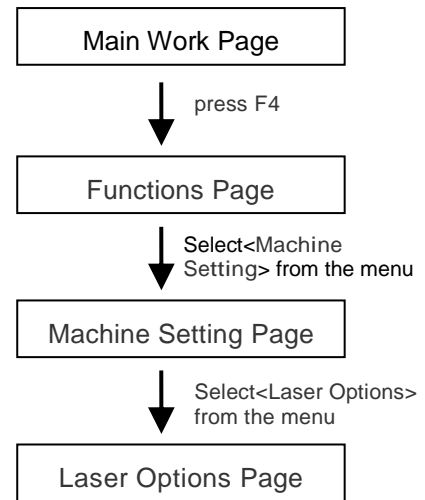

Laser Options Page is for GCC service engineer diagnosis purpose for Spirit GLS Hybrid machine with fiber laser tube only.

Laser Options Page	
Relevant Buttons	Function
F1 (Back)	Back to previous page
F4 (More)	To display information on next page
△ / ▽ Directional	Scroll the display page
Start / Stop	Back to Main Work Page
Auto Focus	Initiate the auto focus function
▲ / ▼ Manual Focus Buttons	Manually adjust the height of the work table (Z-axis)

## Machine Setting- LAN Setup Wizard Page

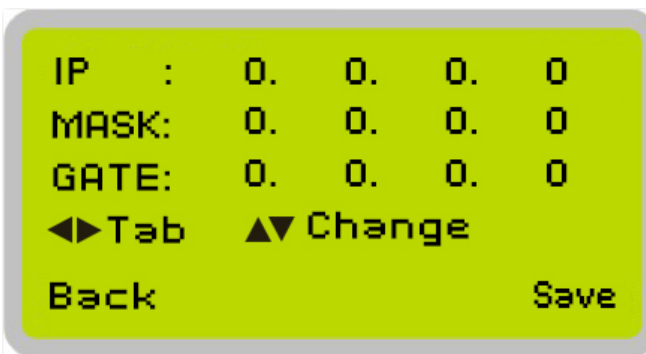
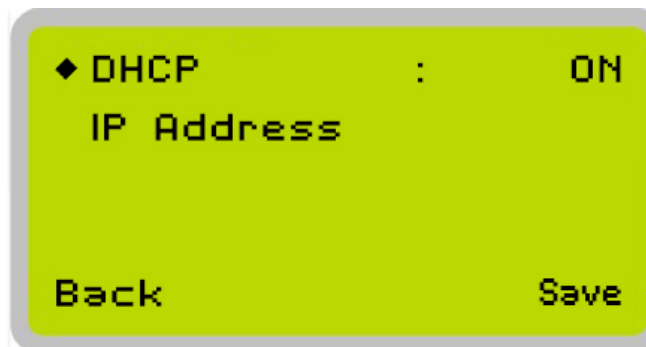
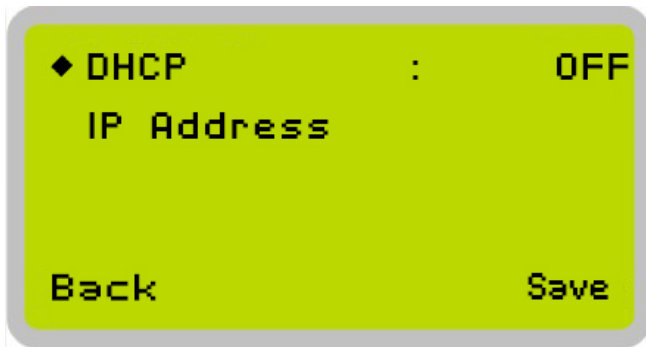

**i** Navigating to this page:

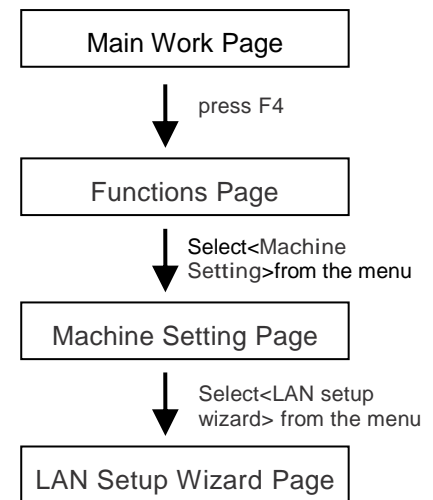

The LAN Setup Wizard Page allows you to connect the laser machine with ethernet to transmit files from computer to laser machine for processing jobs. When selecting the DHCP to <ON>, the network is set up to dynamic IP address, the IP address will automatically retrieve from network; while DHCP <OFF> is to apply static IP address, and you need to further enter the IP address, MASK, and GATE information. Using Left or Right directional keys under dynamic IP setting page to scroll between different columns to enter the address, and use Up or Down keys to change the numbers.

- DHCP: NO/ OFF

Please refer to Chapter 4.1.2 for ethernet connectivity setup in Windows driver.

## LAN Setup Wizard Page

Relevant Buttons	Function
F1 (Back)	Back to previous page
F4 (Save)	Save your current settings
◀ / ▶ Directional	Cycle DHCP between NO/ OFF, or move between tabs on IP address settings
△ / ▽ Directional	Scroll between menu options, or change the numbers of IP address settings.
Start / Stop	Back to Main Work Page
Auto Focus	Initiate the auto focus function
▲ / ▼ Manual Focus Buttons	Manually adjust the height of the work table (Z-axis)

## Machine Setting- Scaling Page

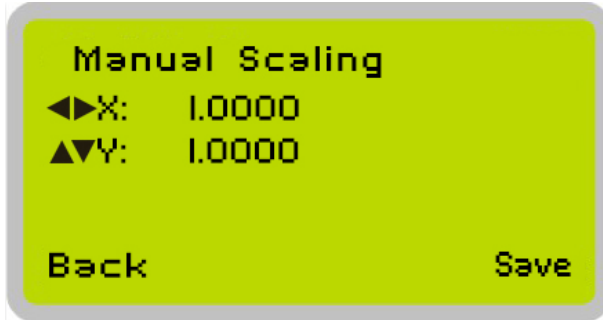

**i** Navigating to this page:

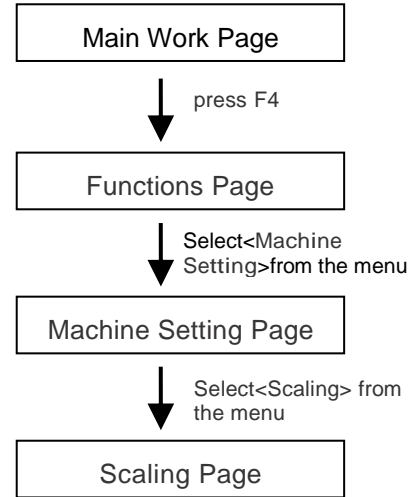

The Scaling Page allows you to fine tune the laser machine output scale to precisely fit the original graphic file design scale when precision output is required to your application.

Please reboot the machine after clicking <Save> button for the change.

Scaling Page	
Relevant Buttons	Function
F1 (Back)	Back to previous page
F4 (Save)	Save your current settings
◁ / ▷ Directional	Adjust the X axis scaling numbers
△ / ▽ Directional	Adjust the Y axis scaling numbers
Start / Stop	Back to Main Work Page
Auto Focus	Initiate the auto focus function
▲ / ▼ Manual Focus Buttons	Manually adjust the height of the work table (Z-axis)



## Machine Setting- Others Page

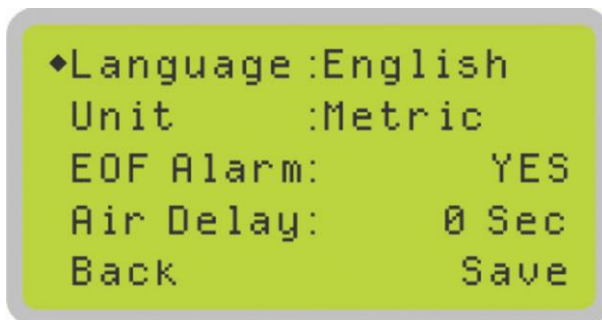

Navigating to this page:

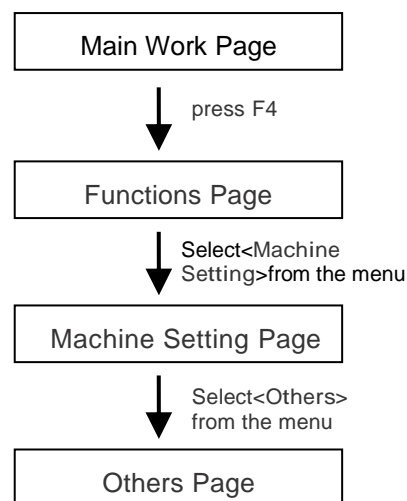

The Others Page allows you to change various settings that correspond to the control panel. The Language setting will allow users to change available languages displayed on the control panel.

The Unit setting will allow you to change whether the units displayed by the control panel is in the metric or imperial system. The EOF (end of file) Alarm setting will enable or disable an audible notification when jobs are complete. The Air Delay setting allows you to specify the delay in seconds of the SmartAIR air-assist after the point of laser firing.

- Language: ENGLISH (others dependent on Firmware)
- Unit: METRIC/ INCH
- EOF Alarm: YES/ NO
- Air Delay: 1-100 seconds



### Tip

Depending on the material you are working with, your laser settings, and the desired results, please experiment with the air delay to achieve your desired results.

Others Page	
Relevant Buttons	Function
F1 (Back)	Back to previous page
F4 (Save)	Save your current settings
△ / ▽ Directional	Scroll through the menu selections
◀ / ▶ Directional	Adjust the value for that selection
Start / Stop	Back to Main Work Page
Auto Focus	Initiate the auto focus function
▲ / ▼ Manual Focus Buttons	Manually adjust the height of the work table (Z-axis)

## Machine Setting- Reset Page

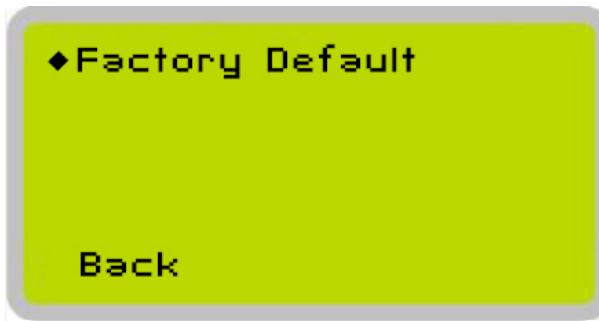

**i** Navigating to this page:

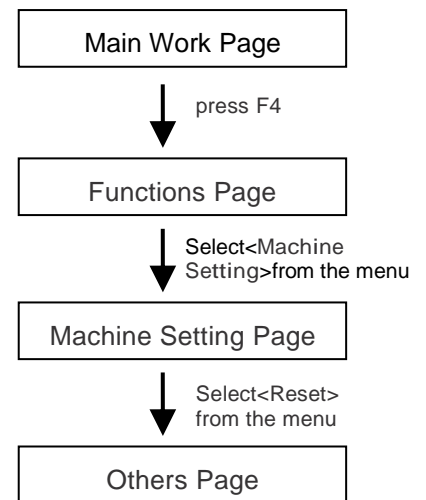

The Reset Page will restore machine settings back to factory default. Press ENTER to confirm the change, and restart the machine.

Reset Page	
Relevant Buttons	Function
F1 (Back)	Back to previous page
△ / ▽ Directional	Scroll through the menu selections
Enter	Perform the selection
Start / Stop	Back to Main Work Page
Auto Focus	Initiate the auto focus function
▲ / ▼ Manual Focus Buttons	Manually adjust the height of the work table (Z-axis)

## Advanced Option Page

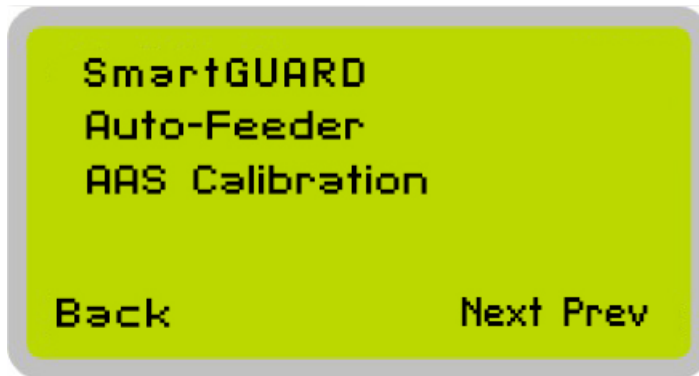

**i** Navigating to this page:

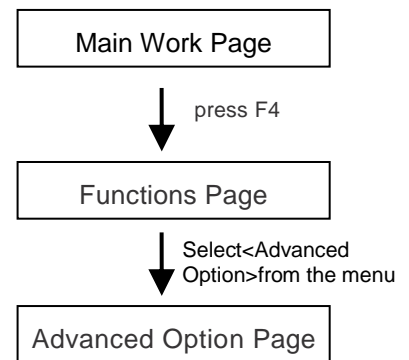

The Advanced Option Page allows you to access multiple setting for laser machine optional peripherals, including SmartGUARD, Auto-Feeder, and AAS Calibration.

Auto-Feeder and AAS Calibration options are only available for those Spirit series machines with CO2 laser tube configuration.

Advanced Option Page	
Relevant Buttons	Function
F1 (Back)	Back to previous page
F3 (Next)	Scroll to next page
F4 (Prev)	Scroll to previous page
△ / ▽ Directional	Scroll through menu options
Enter	Perform the selection
Start / Stop	Back to Main Work Page
Auto Focus	Initiate the auto focus function
▲ / ▼ Manual Focus Buttons	Manually adjust the height of the work table (Z-axis)

## Advanced Option- SmartGUARD Page

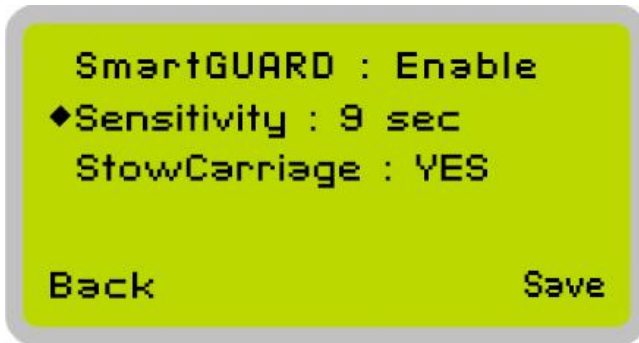

**i** Navigating to this page:

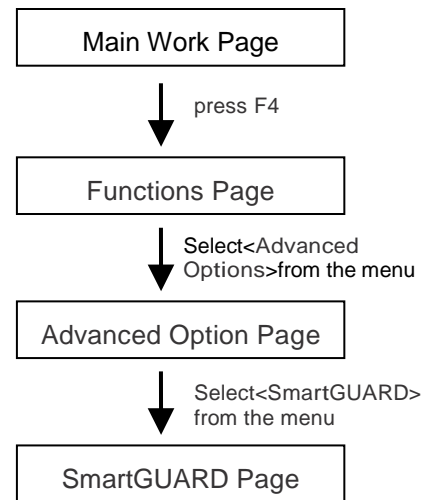

After optional SmartGUARD hardware installation, please enter the function menu on the control panel to enable the SmartGUARD fire alarm. Note SmartGUARD fire alarm system is not a fire extinguisher, but an fire detecting and alarm system.

### SmartGUARD Enable/ Disable:

Press directional key (Left or Right) to enable the SmartGUARD device or disable it.

### Sensitivity :

Press directional key (left or right) to set the sensitivity of SmartGUARD. There are five sensitivity settings (1, 3, 5, 7, 9 seconds) that can be selected. Sensitivity defines the delay time from when a fire is detected until the fire alarm alerts user, and automatically stop laser firing. For example, if the sensor delay switch is set to the 3-second position, the SmartGUARD will start an alarm and automatically stop laser firing after detecting a fire for 3 seconds.

### Stow Carriage :

This function will decide if the lens carriage stay in the last position (set to <NO>) or move to the opposite direction (up or down) when fire alarm is initiated. The default is <YES>, the lens carriage will move to opposite direction when a fire detected.

SmartGUARD Setting Page	
Relevant Buttons	Function
F1 (Back)	Back to previous page
F4 (Save)	Save your current settings
△ / ▽ Directional	Scroll through the menu selections
◁ / ▷ Directional	Adjust the value for that selection
Start / Stop	Back to Main Work Page
Auto Focus	Initiate the auto focus function
▲ / ▼ Manual Focus Buttons	Manually adjust the height of the work table (Z-axis)

## Advanced Option- Auto-Feeder Page

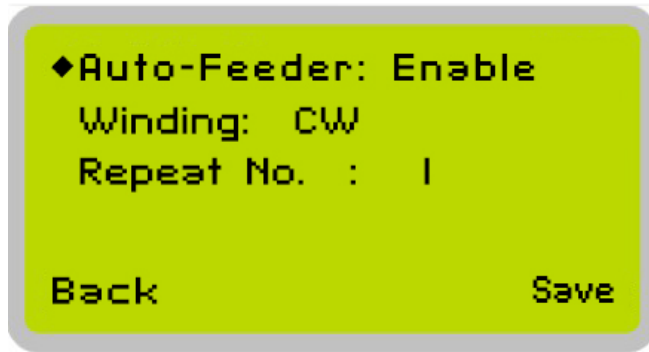

(i) Navigating to this page:

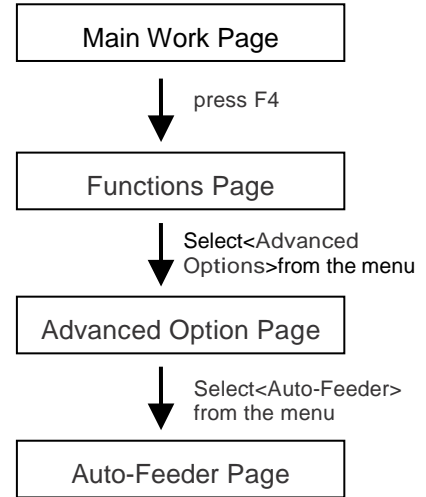

After optional Auto-Feeder hardware installation, please enter the function menu on the control panel to enable the Auto-Feeder roll to roll system. The winding setting will perform the feeder to take up the materials in <CW> (Clockwise) or <CCW> (Counterclockwise) which depends you want to take up the laser cut roll media with printed page toward inside or outside. The <Repeat No.> will decide the times the laser system to output the same jobs after the feeder wind to the next work area/ page. Follow the user manual comes along with the Auto-Feeder hardware for operation details.

- Auto-Feeder: Enable/ Disable
- Winding: CW/ CCW
- Repeat No.: 0-1000 (0 stands for unlimited repeat)

NOTE: Auto-Feeder and AAS Calibration options are only available for those Spirit series machines with CO2 laser tube configuration.

Auto-Feeder Page	
Relevant Buttons	Function
F1 (Back)	Back to previous page
F4 (Save)	Save the settings
◀ / ▶ Directional	Adjust the value for that selection
△ / ▽ Directional	Scroll through the menu selections
Start / Stop	Back to Main Work Page
Auto Focus	Initiate the auto focus function
▲ / ▼ Manual Focus Buttons	Manually adjust the height of the work table (Z-axis)

## Advanced Option- AAS Calibration Page

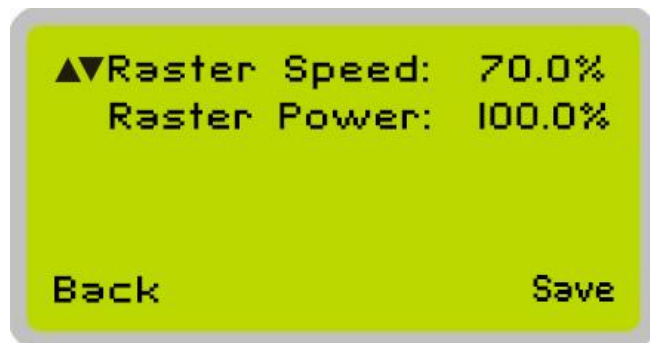
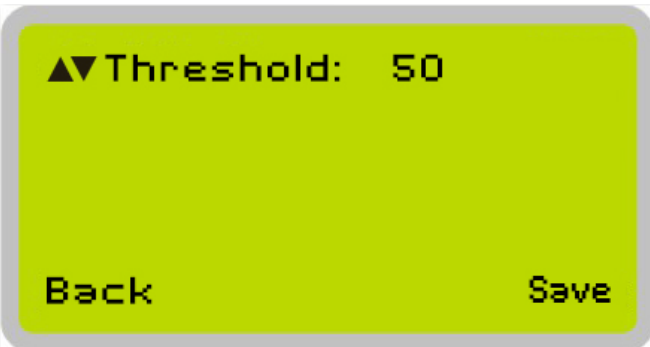
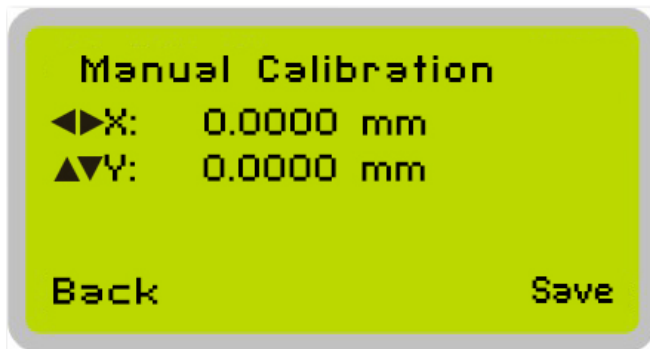
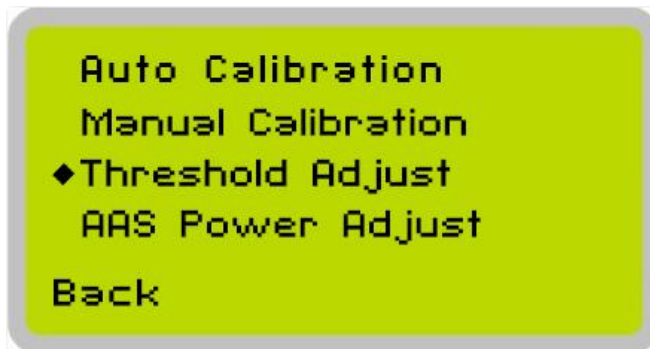

 Navigating to this page:

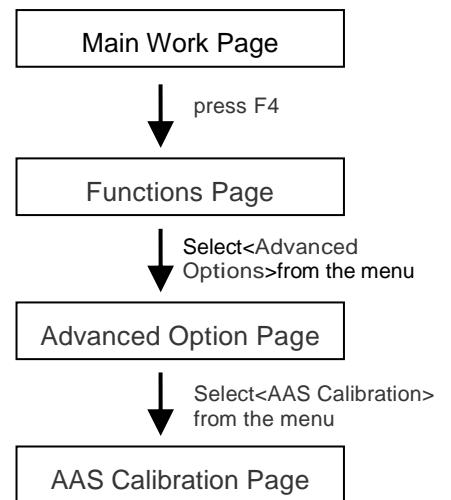

After optional AAS (Accu-Align System) contour cutting hardware installation, please enter the function menu of control panel to perform AAS Calibration before using AAS to do contour cutting job. The AAS Calibration function will fine tune the offset value between AAS and the lens carriage with auto and manual modes options. The <manual calibration> is designed for application requested for more precise offset value. <Threshold> adjustment will help to increase the recognition rate when AAS reading marks is failed. For black marks printed on white substrate, the higher the threshold value, the higher recognition rate the AAS can read the marks; while print white marks on dark substrate, smaller threshold value is suggested. The AAS Power Adjustment

allows changing laser output parameters when doing AAS calibration. Follow the user manual comes along with the AAS hardware for detailed operation.

- Threshold: 1-99 (Default 50)
- Raster Speed: 0-100%
- Raster Power: 0-100%

NOTE: Auto-Feeder and AAS Calibration options are only available for those Spirit series machines with CO2 laser tube configuration.

<b>AAS Calibration Page</b>	
Relevant Buttons	Function
F1 (Back)	Back to previous page
F4 (Save)	Save the settings
△ / ▽ Directional	Scroll through the menu selections
◀ / ▶ Directional	Adjust the value for that selection
Start / Stop	Back to Main Work Page
Auto Focus	Initiate the auto focus function
▲ / ▼ Manual Focus Buttons	Manually adjust the height of the work table (Z-axis)

## Information Page

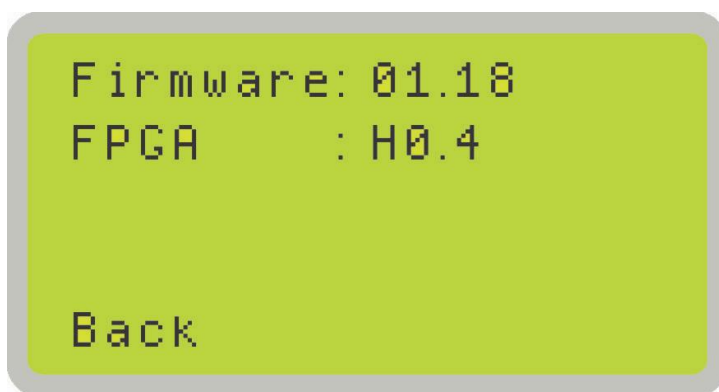

**i** Navigating to this page:

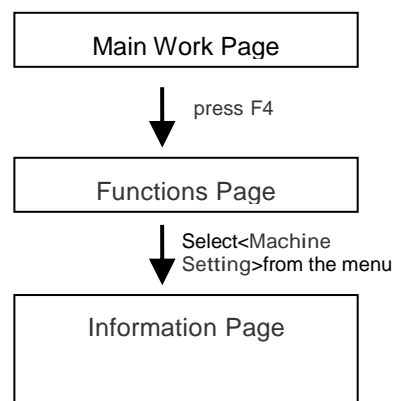

The Information Page allows you to view information regarding the system such as copyright, laser machine name, firmware version, and other information.

Information Page	
Relevant Buttons	Function
F1 (Back)	Back to previous page
△ / ▽ Directional	Scroll through the menu selections
Start / Stop	Back to Main Work Page
Auto Focus	Initiate the auto focus function
▲ / ▼ Manual Focus Buttons	Manually adjust the height of the work table (Z-axis)



## 5.2 The LaserPro Spirit Series Print Driver

With the LaserPro Spirit Series print driver successfully installed, you will need to adjust the printer and page size default settings before you can begin editing and completing jobs. By doing so, you will be setting the work area in your graphics software to match the work table area.

### NOTE

Please make sure the LaserPro Spirit Series is set to the default printer before proceeding to the page and layout setup.

Ensure that the LaserPro Spirit Series has been selected as the DEFAULT PRINTER. You can do so by going into your Windows Control Panel → Printers and Faxes. If the LaserPro Spirit Series is not selected as DEFAULT PRINTER, you may set it up through the graphics software as well. The following example takes CorelDRAW to demonstrate how to set up LaserPro Spirit Series as the Printer

- 1) From the primary menu, click FILE → PRINT SETUP.
- 2) From the navigation bar Name, click Spirit Series → OK

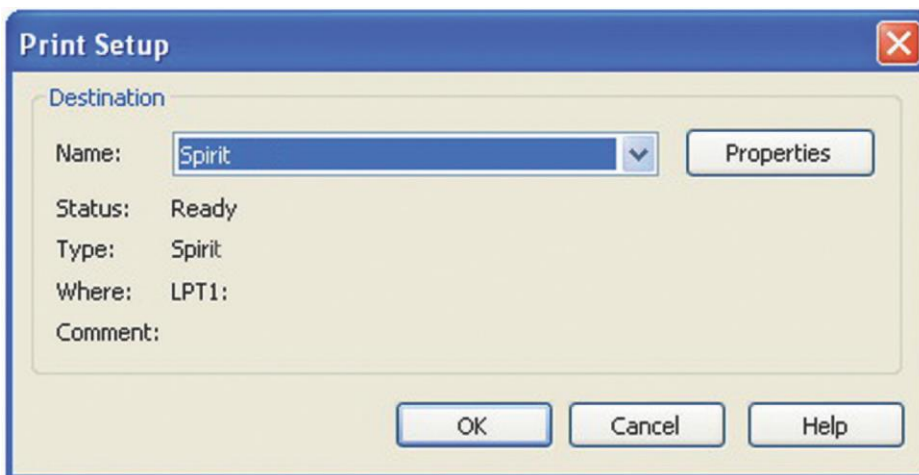

### 5.2.1 Page Setup and Orientation

The first thing you must do before working with the LaserPro Spirit Series Print Driver will be to make sure the page and layout settings are properly configured within your graphics software. You will need to access and edit the Page Setup or Layout page of your graphics software to set your graphics software's page layout to match the LaserPro Spirit Series' work table's dimensions and orientation.

From your graphic software's Page Setup page:

- Set the page orientation in the graphics software to Landscape mode.
- Set page size to match laser machine work area size.
  - Spirit and Spirit LS: 640x460 mm (25.19"x18.11") or 740x460 mm (29.13"x18.11") with extended mode
  - Spirit GLS: 860x610 mm (33.8"x20") or 960x610 mm (37.79"x20") with extended mode

## CoreIDRAW Example (Page Setup and Orientation)

The following is an example of how to set the Page Setup and Orientation in the graphics software. CoreIDRAW is the designated graphics software used for this example. For other graphics software, you will need to access the corresponding Page Setup page.

- 1) From the primary menu, click LAYOUT → PAGE SETUP.
- 2) From the navigation bar on the left, click DOCUMENT → PAGE → SIZE.
- 3) Ensure that NORMAL PAPER and LANDSCAPE are selected.
- 4) Ensure the Paper Width and Height dimensions match the LaserPro Spirit Series work area dimensions
  - Spirit and Spirit LS: 640x460 mm (25.19"x18.11") or 740x460 mm (29.13"x18.11") with extended mode
  - Spirit GLS: 860x610 mm (33.8"x20") or 960x610 mm (37.79"x20") with extended mode
- 5) Click OK to end the paper size adjustment.



### Tip

Instead of manually selecting the Landscape and setting the Paper Width and Height, you can simply click the Set From Printer function and CoreIDRAW will automatically set the proper orientation and dimensions based on LaserPro Spirit Series' work table. (You MUST have the Spirit Series set as the default printer prior to doing this.)

## 5.2.2 Color Management

The LaserPro driver uses pen color settings to control laser engraver's engraving and cutting parameters. In addition to having your Page Setup and Orientation properly set in your graphics software, you will also need to make sure Color Management is DISABLED prior to working with the LaserPro Spirit Series Print Driver.

From your graphic software's Color Management page:

- Disable Color Management or set Color Management to Off.

## CoreIDRAW Example (Color Management)

The following is an example of how to properly disable Color Management in the graphics software. CoreIDRAW is the designated graphics software used for this example. For other graphics software, you will need to access the corresponding Color Management page.

- 1) From the primary menu, click TOOLS → COLOR MANAGEMENT and CoreIDRAW's Color Management will appear.
- 2) Under the Style pull down menu, select COLOR MANAGEMENT OFF.
- 3) Click OK to complete the color management adjustments.

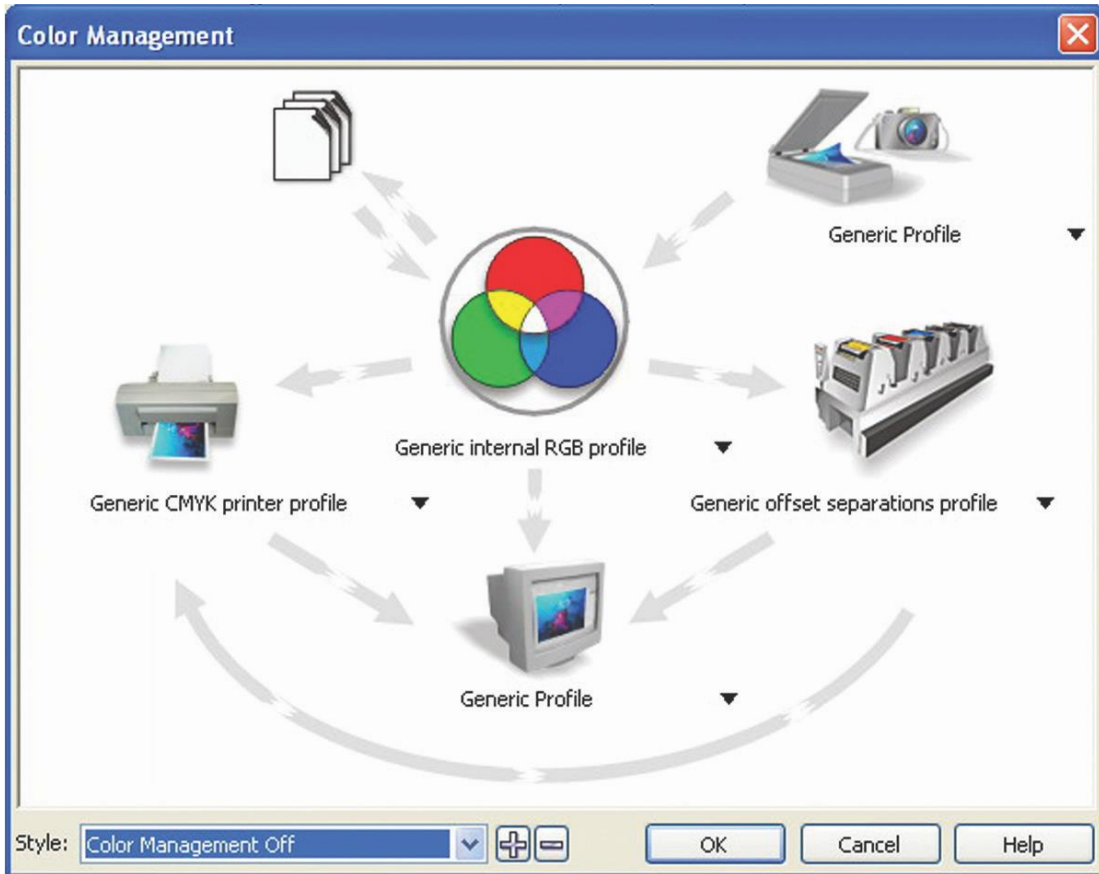

### 5.2.3 Using the LaserPro Print Driver

Now after you have properly set the Page and Layout and Color Management of your graphics software, you are ready to configure the details of your actual job through the LaserPro print driver. The LaserPro print driver allows you to adjust your engraving / cutting options. After you have setup your image, design, or text to be engraved in your software application, you can access the LaserPro Spirit Series print driver by going to <FILE> → <PRINT>→ <PROPERTIES>.

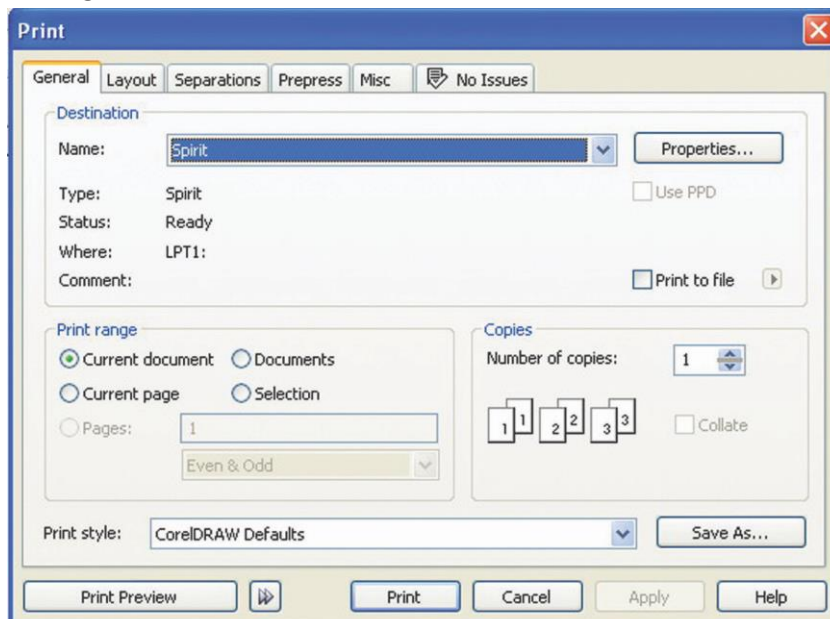

## NOTE

CorelDRAW was used as the software application for this screenshot example.

The LaserPro Spirit Series Print Driver consists of seven primary sections (pages) in which you will be able to choose various engraving / cutting options and settings:

- Options Page
- Pen Page
- Advanced Page
- Paper Page
- Language Page
- Raster Page (appears only in Black & White Mode)
- Stamp Page (appears only in Stamp Mode)



### Tip

The following sections describe the specific functions for each of the settings found in the LaserPro Spirit Series Print Driver. If you are new to laser engraving, it is recommended that you first familiarize yourself with the general principles of the laser process in Section 6, especially the Vector Cutting and Raster Engraving concepts. This will make it easier to understand the various descriptions and terminologies used in this section.

### 5.2.3.1 LaserPro Spirit Series Print Driver >> Options Page

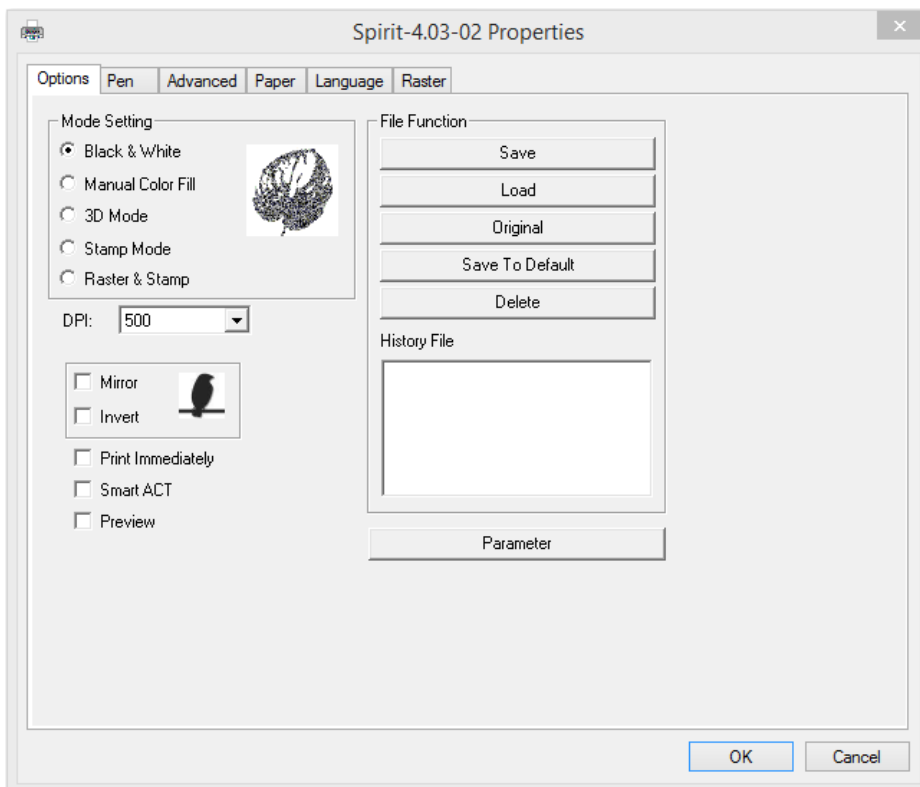

## Mode Setting (OPTIONS PAGE) [DEFAULT SETTING: Black & White]

You can select from four primary mode settings, depending on your application or results you would like to achieve.

### Black & White:

Select this mode when using clipart images or drawings with several colors, shades of gray, or many outlines. This mode outputs in a method similar to that of a black and white laser printer.

The GCC LaserPro print driver will interpret colored and shaded areas as 256-level shades of gray by producing a halftone effect while engraving. Instead of engraving only solid lines, gray or halftone areas will be a collection of dots with varying density.

The entire selected image will be engraved using a single set of power and speed settings (the black pen from the PEN menu. Please refer to the next section of the details regarding the PEN functions). The resolution and depth of these halftone areas can be adjusted with the DPI setting found on the Options page. Please note that selecting the Black & White mode will add a new Raster page to the menu. The Black & White mode dithering settings can be changed from the Raster page. (Please refer to the Raster section below for details). Experiment with different dithering settings to attain the desired results.



### Tip

The Black & White mode interprets the processed image by the varying colors and shades. For the best results, we suggest you convert the image to a grayscale image with your graphics software prior to engraving in the Black & White mode.

### NOTE

Selecting the Black & White mode will enable the Raster page on the GCC LaserPro Print Driver, allowing you to adjust advanced stamp-related settings.

### Manual Color Fill:

Specify laser type to different color pens. The GCC LaserPro print driver allows a maximum of 16 pen parameters to be set. It will help user to set different parameters easily in one file.

Pen No.	Color	Speed	Power	PPI	Raster	Vector	Air	AF	Defocus	Bridge	Repeat
1	Black	50.0	50	400	YES	YES	NO	NO	0.0	5	1
2	Red	50.0	50	400	YES	YES	NO	NO	0.0	0	1
3	Green	50.0	50	400	YES	YES	NO	NO	0.0	0	1
4	Yellow	50.0	50	400	YES	YES	NO	NO	0.0	0	1
5	Blue	50.0	50	400	YES	YES	NO	NO	0.0	0	1
6	Magenta	50.0	50	400	YES	YES	NO	NO	0.0	0	1
7	Cyan	50.0	50	400	YES	YES	NO	NO	0.0	0	1
8	Brown	50.0	50	400	YES	YES	NO	NO	0.0	0	1
1*	Light Green	50.0	50	400	YES	YES	NO	NO	0.0	1	1
10	Light Yellow	50.0	50	400	YES	YES	NO	NO	0.0	0	1
11	Light Blue	50.0	50	400	YES	YES	NO	NO	0.0	0	1
12	Light Magenta	50.0	50	400	YES	YES	NO	NO	0.0	0	1

Speed:	< [Slider] >	50.0	<input checked="" type="checkbox"/> Raster
Power:	< [Slider] >	50	<input checked="" type="checkbox"/> Vector
PPI:	< [Slider] >	400	<input type="checkbox"/> Air
Defocus:	< [Slider] >	0.0 mm	<input type="checkbox"/> Auto Focus
Bridge:	< [Slider] >	0 mm	<input type="checkbox"/> Defocus
			<input type="checkbox"/> Bridge Cutting
			Repeat: <input type="text" value="1"/>

### 3D Mode:

3D Mode allows the naked eyes to visualize the curvatures of the 3D effect by applying 200 grayscale power level technology to create different depth of engraving.

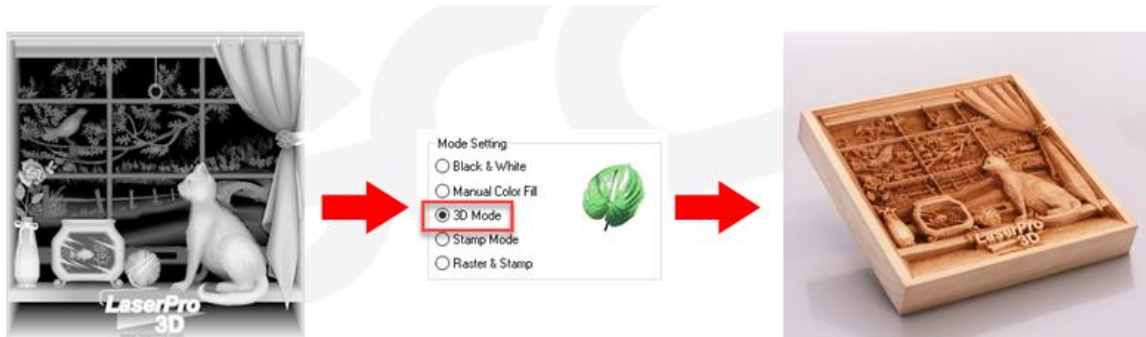

### Stamp Mode:

The stamp mode is one of the more dynamic functions of the LaserPro laser engravers by applying 200 power level to create different steps.



### NOTE

Selecting the Stamp mode will enable the Stamp page on the Spirit Series Print Driver, allowing you to adjust advanced stamp-related settings.

### Raster & Stamp Mode:

Select this mode when you would like to engrave image on stamps. The Raster & Stamp mode combines the 256 level gray scale image processing technology and 200 power level stamp steps production requirement to create slopes.

Noted Raster & Stamp mode is only suitable for CO2 laser system (Spirit, Spirit LS, Spirit GLS, Spirit GLS Hybrid CO2 models), not suitable for Spirit GLS Hybrid fiber laser, and CO2/Fiber dual lasers configurations.

### DPI (Options Page) [DEFAULT SETTING: 500]

DPI (dots-per-inch) represents the number of times the laser will fire over a one-inch path. This setting determines the image resolution and quality when performing raster engraving functions. Higher DPI settings result in cleaner and deeper engravings, but require more time to complete. Lower DPI settings result in coarser and shallower engravings, but require less time to complete. The LaserPro Spirit Series offers 8 DPI options: 125, 250, 300, 380, 500, 600, 760, 1000, and 1500 experiment with different settings to get your desired effect.

Below is a chart for your convenience detailing the Set DPI (your input setting) vs. Actual DPI (your output results).

Set DPI	125	250	300*	380	500	600*	760	1000	1500
Actual DPI	127	254	381	381	508	762	762	1016	1524

**NOTE**  
 Outputting a full-table (25.1" x 18.1") job using 300 or 600 DPI will result in a truncation error; this is due to the large differences in set DPI vs. actual DPI output for those two particular DPI settings. Therefore, when processing a 25.1" x 18.1" job using 300 DPI, we recommend you move to the next higher DPI setting of 380. Similarly, for a 25.1" x 18.1" job using 600 DPI, we recommend you use 760 DPI.

**Mirror (Options Page) [DEFAULT SETTING: Unselected]**

Checking this box will automatically engrave your image with a mirrored effect. This setting will flip the image along the Y-axis from left to right and vice-versa.



**Tip** .....

When engraving a stamp, via the stamp mode, the stamp image needs to be engraved in reverse (mirrored) for the final stamp to be correctly laid out.

.....



**Invert (Options Page) [DEFAULT SETTING: Unselected]**

Checking this box automatically inverts / reverses the color of your image (the white areas become black and vice versa). The Invert option is not available if disabled while Manual Color File mode is selected.



**Tip** .....

Invert mode is useful when creating a stamp in Stamp Mode, as inverting your normal image will set the negative space to be engraved out, with the remaining positive space (your stamp design) protruding out.

.....

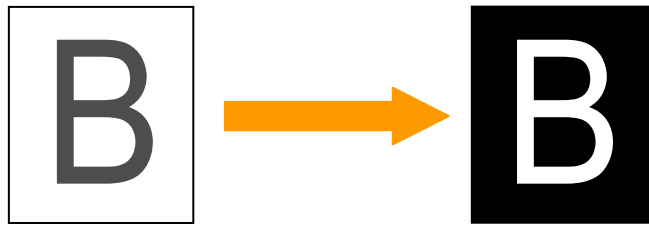

### Print Immediately (Options Page) [DEFAULT SETTING: Unselected]

Checking this will instruct the LaserPro Spirit Series to immediately begin the laser engraving process, when you select Print from your graphic software program. If Print Immediately is not checked, then selecting Print will transfer the job file to the LaserPro Spirit Series system and will need to be initialized from the LaserPro Spirit Series control panel.

### SmartACT (Options Page) [DEFAULT SETTING: Unselected]

By eliminating unnecessary travel of the lens carriage at the expense of some quality, SmartACT reduces the acceleration area to save of time to process a job~!

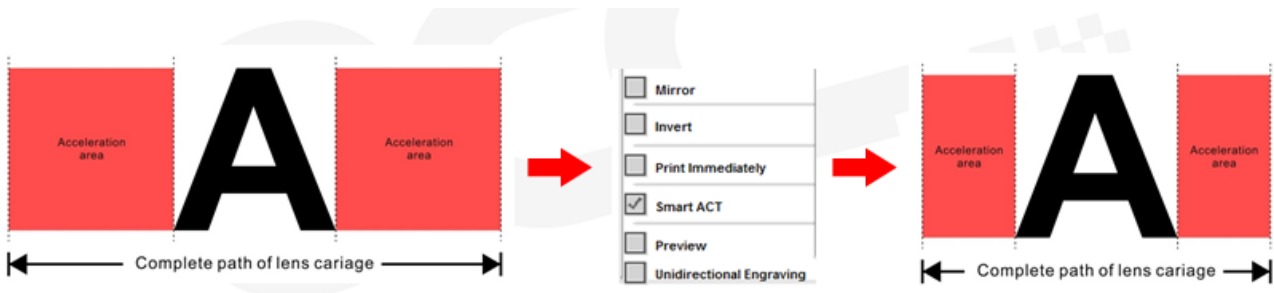

### Tip

There is a greater performance gain when enabling SmartACT for designs that are vertically longer than they are horizontally wide, as the SmartACT optimization modifies the movement of the X-axis of the lens carriage.



## Preview (Options Page) [DEFAULT SETTING: Unselected]

Users can use the Preview function to check a simulated output of the job. An estimated working time will also be shown. Please make sure to set the file printing option to “print to file” in order to activate the Preview function.

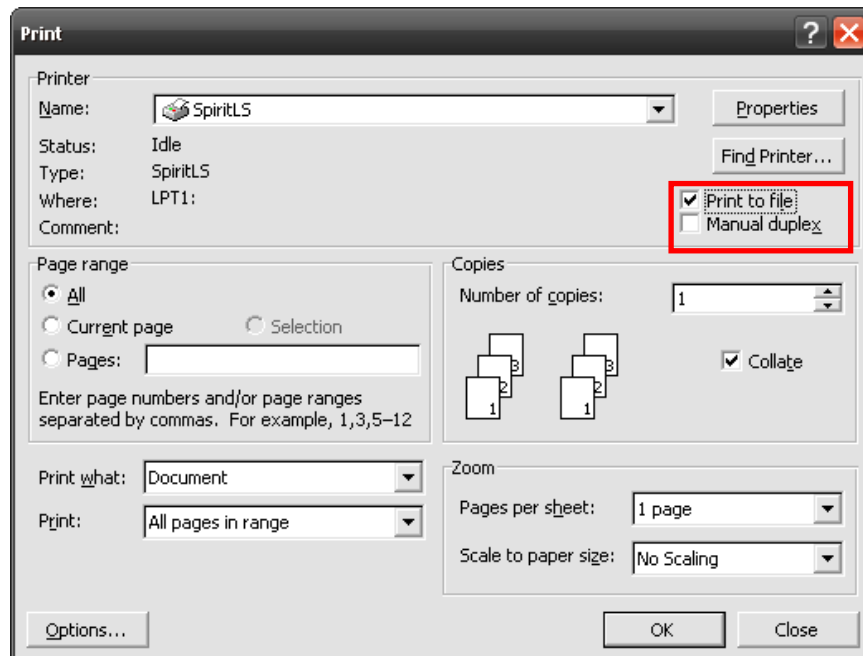

A filename will be prompted.

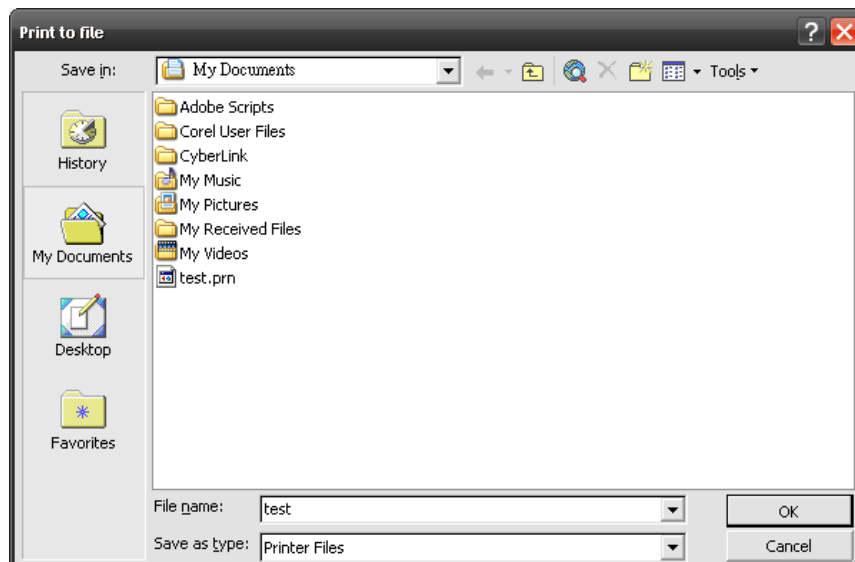

After entering the filename and pressing <ok>, the Preview screen will be shown.

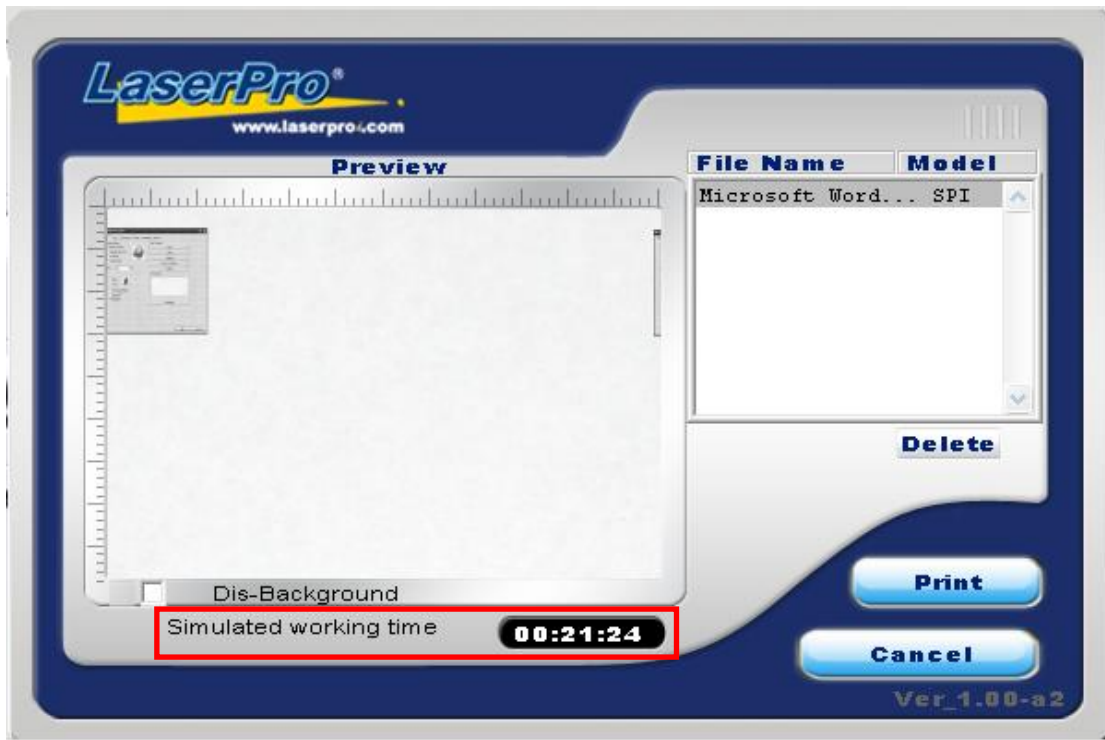

The output file can be previewed and an estimated working time of the job is also displayed.

#### File Function (Options Page):

The file function section allows you to manage various laser parameters. This section is useful when performing duplicate jobs on a variety of objects, allowing you to save your frequently used laser parameters and load them in the future.

- History File: This section contains a list of the recent files you have recently created and worked with.
- SAVE: This function will save the current print driver parameter settings to a file and location on your computer of your selection. (Saved parameter setting files will be tagged with the .Spi extension)
- LOAD: This function allows you to load those previously saved print driver parameters.
- ORIGINAL: This function will load the print driver's original factory parameter settings.
- SAVE TO DEFAULT: This function allows you to save your current print driver parameters as the default startup settings.

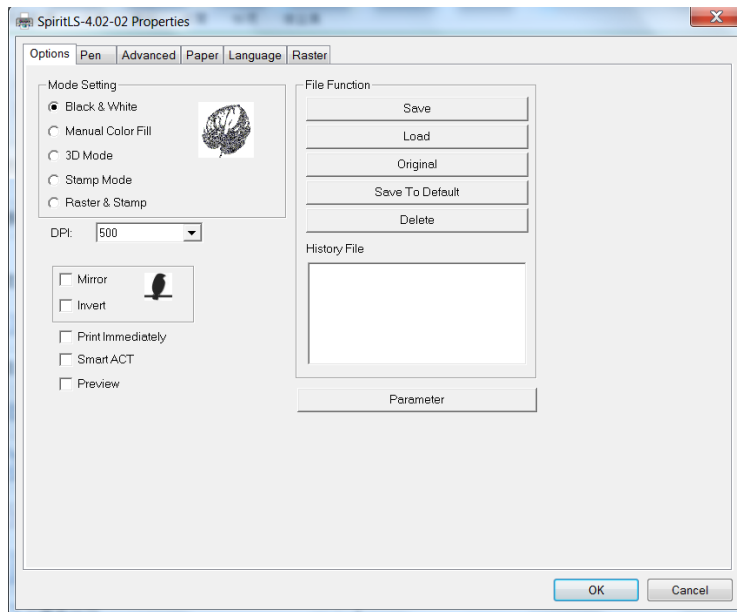

- **PARAMETER:** The material database consists of pre-built-in parameter settings to work with a wide variety of materia including wood, acrylic, glass, 2py-laminated plastic, marble, tiles, rubber, coated metal, and more. With this convenient function, users can easily set up their tool by selecting the appropriate job type (engraving or cutting) and material categories for the corresponding parameters to be applied.

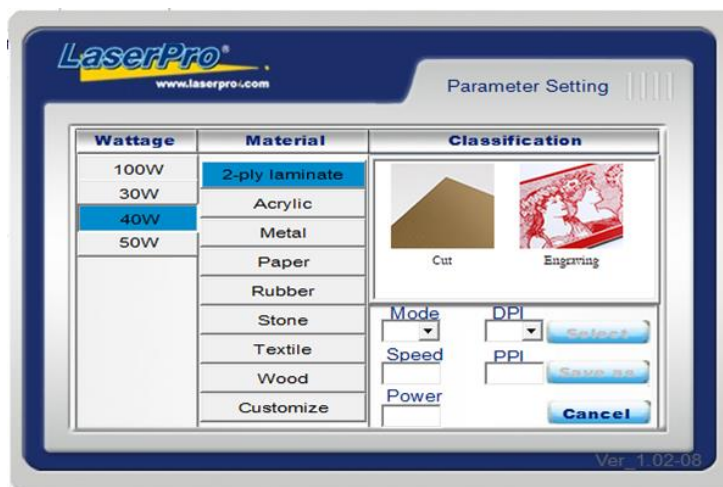

- **DELETE:** This function will delete the file you select from the History File section. Please note the Delete function only removes the file from the history file section, it does not remove the .Spi file from your hard drive, if you wish to completely remove the file from your hard disk, then you will have to manually delete the file from your operating system.)

## NOTE

If you are using Windows 2000 or above as your operating system, make sure you log in with an administrator or administrator-rights account in order to properly save laser parameter settings.



## Tip

LaserPro material database settings allow you easy to load the several parameters.

If you are loading LaserPro parameter database as your operating parameter, please click <Parameter> under OPTIONS page, and direct load from several build-in parameter folders.

### 5.2.3.2 Spirit Series Print Driver >> Pen Page

The LaserPro Spirit Series incorporates the use of 16 different colors to represent 16 different laser power and speed settings when cutting and engraving. These colors are referred to as "Pens". Think of each pen as a designated laser setting, rather than as a color. As an example, a black and white image will use only one power and speed laser setting (Black). An image that is made up of black, red and blue colors will be processed using the laser settings designated for each particular color. In order to utilize up to 16 different pens (laser parameter settings), make sure your graphics software can recognize and utilize the 16 pen colors designated by the Spirit Series print driver.

#### [Pen Page of Spirit/ Spirit LS/ Spirit GLS Models:](#)

**SpiritGLS-4.04-02 Properties**

Option Pen Advance Paper Language Raster

Pen No.	Color	Speed	Power	PPI	Raster	Vector	Air	AF	Defocus	Bridge	Repeat
1	Black	50.0	50	400	YES	YES	NO	NO	0.0	0	1
2	Red	50.0	50	400	YES	YES	NO	NO	0.0	0	1
3	Green	50.0	50	400	YES	YES	NO	NO	0.0	0	1
4	Yellow	50.0	50	400	YES	YES	NO	NO	0.0	0	1
5	Blue	50.0	50	400	YES	YES	NO	NO	0.0	0	1
6	Magenta	50.0	50	400	YES	YES	NO	NO	0.0	0	1
7	Cyan	50.0	50	400	YES	YES	NO	NO	0.0	0	1
8	Light Blue	50.0	50	400	YES	YES	NO	NO	0.0	0	1
9	Light Green	50.0	50	400	YES	YES	NO	NO	0.0	0	1
10	Light Yellow	50.0	50	400	YES	YES	NO	NO	0.0	0	1
11	Light Purple	50.0	50	400	YES	YES	NO	NO	0.0	0	1
12	Light Pink	50.0	50	400	YES	YES	NO	NO	0.0	0	1

Speed: < 50.0 >  
 Power: < 50 >  
 PPI: < 400 >  
 Defocus: < 0.0 mm >  
 Bridge: < 0 mm >

Raster  
 Vector  
 Air  
 Auto Focus  
 Defocus  
 Bridge Cutting

Repeat: 1

OK Cancel

[Pen Page of Spirit GLS Hybrid Model:](#)

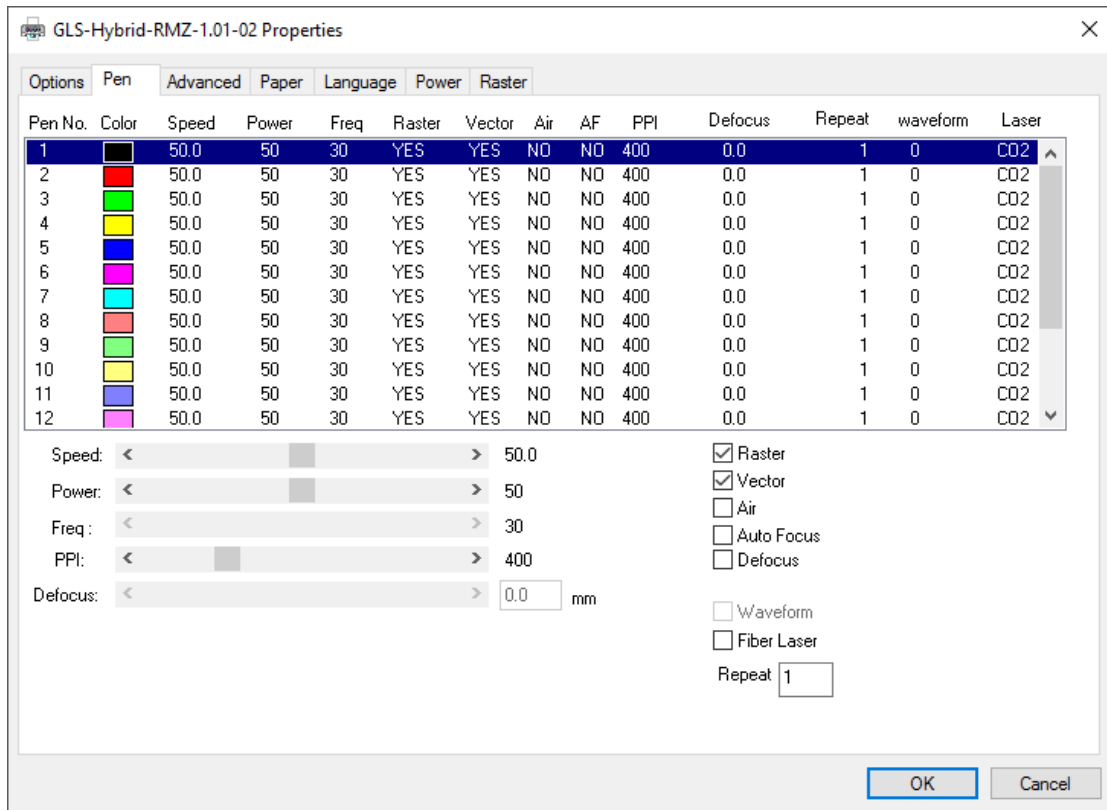

If you would like to specify your own colors to designate to a particular laser setting, then all you have to do is to double-click on that particular pen color from the pen menu and a color manager window will open where you can select “define custom colors” to define your own color (shown in the picture below). This is useful when your image is composed of colors that are not part of the pen menu’s default color selection, and instead of modifying your image, you simply assign the laser settings based on the existing colors depicted from your current image.

**NOTE**

The Spirit Series print driver cannot store more than 16 pen colors or different laser parameter settings per file.

**Speed (Pen Page) [DEFAULT SETTING: 50]**

The speed slider controls the laser’s speed during operation (engraving speed) with settings ranging from 0.1 – 100%. Keep in mind, the speed setting refers to the lens carriage moves at when cutting or engraving straight lines. The machine will automatically slow down when processing curves.



**Tip**

Cutting / engraving depth and quality are determined by a combination of power and speed. Slower speeds at higher power will produce deeper cuts and engravings, whereas higher speeds at lower power will produce more shallow cuts and engravings.

### Power (Pen Page) [DEFAULT SETTING: 50]

The power slider controls the laser's power during operation (engraving power) with a range setting from 0 – 100%. The percentage setting represents the power for each laser pulse fired.

### PPI (Pen Page) [DEFAULT SETTING: 400]

PPI (pulses-per-inch) represents the number of times the laser pulses (fires) per linear inch, exclusive for vector cutting. Higher PPI settings will generate deeper, overlapping laser pulses, resulting in cleaner cuts. Lower PPI settings (lower than 150) will result in the individual laser pulses being spread apart, resulting in a perforated effect (similar to the perforation in the paper between mailing stamps).

If you drag the PPI slider to the furthest right (maximum), the value will change to X. This completely disables the PPI control and continuously fires the laser non-stop, without pulsing. Think of setting PPI to X as being equivalent to turning a water faucet on with the water continuously flowing out. This also disables the power ramp functionality, which automatically controls the PPI depending on the speed of the lens carriage (such as vector cutting around the corner of a square).



#### Tip .....

Cutting / engraving depth and quality are determined by a combination of power and speed. Slower speeds at higher power will produce deeper cuts and engravings, whereas higher speeds at lower power will produce shallower cuts and engravings.

### Raster / Vector (Pen Page) [DEFAULT SETTING: Selected]

Checking the Raster checkbox will process only the raster functions for the areas of your design that correspond to that particular "pen" color.

Checking the Vector checkbox will process the vector functions for the areas of your design that correspond to that particular "pen" color.

As an example: a particular "pen" color may be assigned to areas in your design containing color fills (raster engraving) and very thin lines (vector cutting). By checking / unchecking the Raster and Vector will force the driver to process / ignore the color fills / thin lines.

	Vector Checked	Vector Unchecked
Raster Checked	Processes both Vector and Raster functions for that particular color	Processes only the Raster functions for that particular color (Vector functions ignored)
Raster Unchecked	Processes only the Vector functions for that particular color (Raster functions ignored)	Does not process Vector or Raster functions for that particular color

**Fiber Laser (Pen Page) [DEFAULT SETTING: Unselected]** (only for Spirit GLS Hybrid model)

You can assign Pen to apply different laser tube for Spirit GLS Hybrid model, CO2 laser as the default, by selecting “Fiber Laser” option to switch the corresponding Pen No. to apply fiber laser. Only when assign the specified Pen to Fiber Laser, the related fiber laser settings, ie. Freq. and Waveform can be adjusted for that Pen.

Pen No.	Color	Speed	Power	Freq	Raster	Vector	Air	AF	PPI	Defocus	Repeat	waveform	Laser
1	Black	50.0	50	30	YES	YES	NO	NO	400	0.0	1	0	CO2
2	Red	50.0	50	30	YES	YES	NO	NO	400	0.0	1	1	Fiber
3	Green	50.0	50	30	YES	YES	NO	NO	400	0.0	1	0	CO2
4	Yellow	50.0	50	30	YES	YES	NO	NO	400	0.0	1	1	Fiber
5	Cyan	50.0	50	30	YES	YES	NO	NO	400	0.0	1	0	CO2
6	Magenta	50.0	50	30	YES	YES	NO	NO	400	0.0	1	1	Fiber
7	Blue	50.0	50	30	YES	YES	NO	NO	400	0.0	1	0	CO2
8	Orange	50.0	50	30	YES	YES	NO	NO	400	0.0	1	0	CO2
9	Light Green	50.0	50	30	YES	YES	NO	NO	400	0.0	1	0	CO2
10	Light Yellow	50.0	50	30	YES	YES	NO	NO	400	0.0	1	0	CO2
11	Light Blue	50.0	50	30	YES	YES	NO	NO	400	0.0	1	0	CO2
12	Light Purple	50.0	50	30	YES	YES	NO	NO	400	0.0	1	0	CO2

**Freq (Pen Page) [DEFAULT SETTING: 30]** (only for Spirit GLS Hybrid model)

Freq (frequency) determines the peak power of the laser which affects the color variation and depth of the laser marking. A lower frequency will produce a deeper marking. You can drag the Freq. slider to the experiment the output.

Notice to select “Fiber Laser” for the corresponding pen No. first before adjusting fiber laser related parameters like Freq. and Waveform.

**Waveform (Pen Page) [DEFAULT SETTING: Unselected]** (only for Spirit GLS Hybrid model)

GCC Fiber Laser is equipped an unique Waveform function to give users greater control over laser pulse parameters that can lead to more efficient and effective processing. An example would be the use of low repetition rate, high-energy pulses to rough out and remove the bulk of the material while a higher frequency shorter pulse with less energy can subsequently be used in a polishing pass yielding a better surface finish.

Remember to select “Fiber Laser” first for the desired Pen No. before enable Waveform function. The Waveform value will turn into “1” when the option is enabled.

To achieve a high quality finish, Waveforms are used to maintain control of the engraving process. When engraving starts, a less aggressive pulse is initially used in order to avoid a perimeter ridge around the engraved area. Then the Waveforms can be switched to a long high energy pulse with its higher material removal rate. Throughout this process, a short pulsed Waveforms is regularly used to clean the engraved area which helps to remove dross and debris. After the engraving process has finished, the surrounding area is Laser cleaned using a short Waveforms to remove any surface deposits. Note that there is a trade-off between material removal rate and engraving quality.

Below is the waveform parameter table for different fiber laser models:

Waveform Number	20RMZ			30RMZ			50RMZ		
	Pulse Duration (ns)	Pulse Frequent (kHz)	Pulse Energy (mJ)	Pulse Duration (ns)	Pulse Frequent (kHz)	Pulse Energy (mJ)	Pulse Duration (ns)	Pulse Frequent (kHz)	Pulse Energy (mJ)
0	260/40	20	1	260/40	30	>1	260/40	50	>1
1	40/26	90	0.2	40/26	140	>0.2	40/26	250	>0.2

### Air (Pen Page) [DEFAULT SETTING: Unselected]

This checkbox controls the SmartAIR air-assist function (if you have the optional air compressor installed). By selecting a pen color and checking this box will enable the SmartAIR air-assist function for that particular pen color. As an example, if you are performing a combination of both surface raster engraving job and deep vector cutting on a material such as acrylic, you may want to enable the SmartAIR air-assist for the vector cutting sections to get the cleanest cuts. To do this, you would simply need to select the pen color that you have assigned to the sections to be cut and select the Air checkbox for those particular pen colors.

### NOTE

In order to use the Air Delay function under the firmware or the Air assist function in the driver, make sure that the optional air compressor is connected to the power outlet located in the lower machine cabinet. There are two power outlets located in the right hand side of the lower machine cabinet, make sure that the air compressor is connected to the power outlet towards the left which is closer to the fuse.

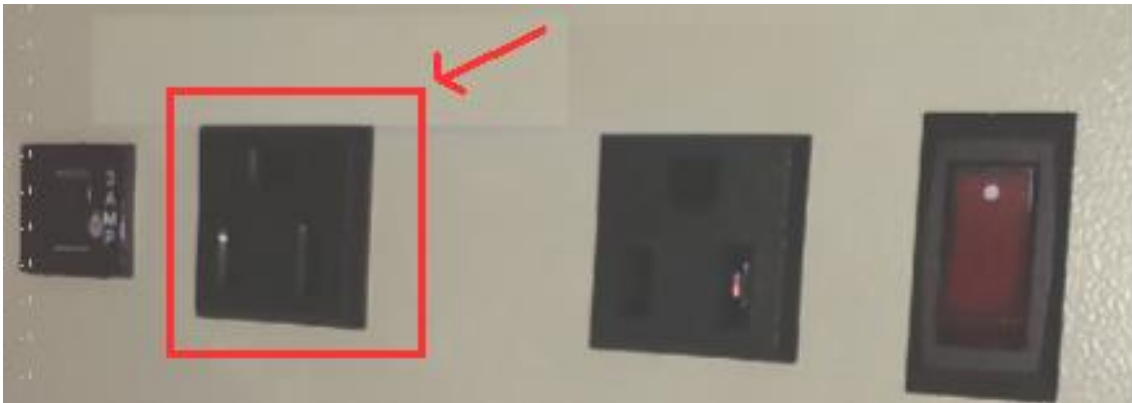

### Auto Focus (Pen Page) [DEFAULT SETTING: Unselected]

This checkbox sets the Auto Focus for that particular job. With the Auto Focus button checked, the Spirit will automatically initialize the auto focus procedure before starting the job. This will ensure the focal distance is properly set based on the particular material you are working with and the focal lens you have installed.



## Defocus (Pen Page) [DEFAULT SETTING: Unselected]

This checkbox enables users to set the Defocus or out of focus distance for a particular job. With the Defocus button checked, the Spirit Series will use the entered focus distance when performing the auto focus procedure before starting the job. This feature allows users to use out of focus engraving techniques when working with different types of materials. Note that the Defocus distance is set by the different pen colors.

Pen No.	Color	Speed	Power	Freq	Raster	Vector	Air	AF	PPI	Defocus	Repeat	waveform	Laser
1	Black	50.0	50	30	YES	YES	NO	NO	400	4.0	1	0	CO2
2	Red	50.0	50	30	YES	YES	NO	NO	400	0.0	1	0	CO2
3	Green	50.0	50	30	YES	YES	NO	NO	400	0.0	1	0	CO2
4	Yellow	50.0	50	30	YES	YES	NO	NO	400	0.0	1	0	CO2
5	Blue	50.0	50	30	YES	YES	NO	NO	400	0.0	1	0	CO2
6	Magenta	50.0	50	30	YES	YES	NO	NO	400	0.0	1	0	CO2
7	Cyan	50.0	50	30	YES	YES	NO	NO	400	0.0	1	0	CO2
8	Brown	50.0	50	30	YES	YES	NO	NO	400	0.0	1	0	CO2
9	Light Green	50.0	50	30	YES	YES	NO	NO	400	0.0	1	0	CO2
10	Light Blue	50.0	50	30	YES	YES	NO	NO	400	0.0	1	0	CO2
11	Light Purple	50.0	50	30	YES	YES	NO	NO	400	0.0	1	0	CO2
12	Light Cyan	50.0	50	30	YES	YES	NO	NO	400	0.0	1	0	CO2

Speed: < [Slider] > 50.0  
 Power: < [Slider] > 50  
 Freq: < [Slider] > 30  
 PPI: < [Slider] > 400  
 Defocus: < [Slider] > 4.0 mm

Raster  
 Vector  
 Air  
 Auto Focus  
 Defocus  
 Waveform  
 Fiber Laser  
 Repeat: 1

## Bridge Cutting (Pen Page) [DEFAULT SETTING: Unselected / 0.0 mm]

Checking the Bridge Cutting checkbox will allow users to easily create perforation lines (dash-line). Once set the line color along with another corresponding pen can be used in tandem to indicate the length of the gap and the uncut part of a perforation line. (If Pen 1 is selected for bridge cutting, Pen 9 will be reserved to the length of the connected lines of the perforation. If Pen 2 is selected, Pen 10 will be reserved and so on...)

Pen No.	Color	Speed	Power	PPI	Raster	Vector	Air	AF	Defocus	Bridge	Repeat
1	Black	50.0	50	400	YES	YES	NO	NO	0.0	5	1
2	Red	50.0	50	400	YES	YES	NO	NO	0.0	0	1
3	Green	50.0	50	400	YES	YES	NO	NO	0.0	0	1
4	Yellow	50.0	50	400	YES	YES	NO	NO	0.0	0	1
5	Blue	50.0	50	400	YES	YES	NO	NO	0.0	0	1
6	Magenta	50.0	50	400	YES	YES	NO	NO	0.0	0	1
7	Cyan	50.0	50	400	YES	YES	NO	NO	0.0	0	1
8	Brown	50.0	50	400	YES	YES	NO	NO	0.0	0	1
9	Light Green	50.0	50	400	YES	YES	NO	NO	0.0	1	1
10	Light Blue	50.0	50	400	YES	YES	NO	NO	0.0	0	1
11	Light Purple	50.0	50	400	YES	YES	NO	NO	0.0	0	1
12	Light Cyan	50.0	50	400	YES	YES	NO	NO	0.0	0	1

Speed: < [Slider] > 50.0  
 Power: < [Slider] > 50  
 PPI: < [Slider] > 400  
 Defocus: < [Slider] > 0.0 mm  
 Bridge: < [Slider] > 5 mm

Raster  
 Vector  
 Air  
 Auto Focus  
 Defocus  
 Bridge Cutting  
 Repeat: 1



### 5.2.3.3 Spirit Series Print Driver >> Advanced Page

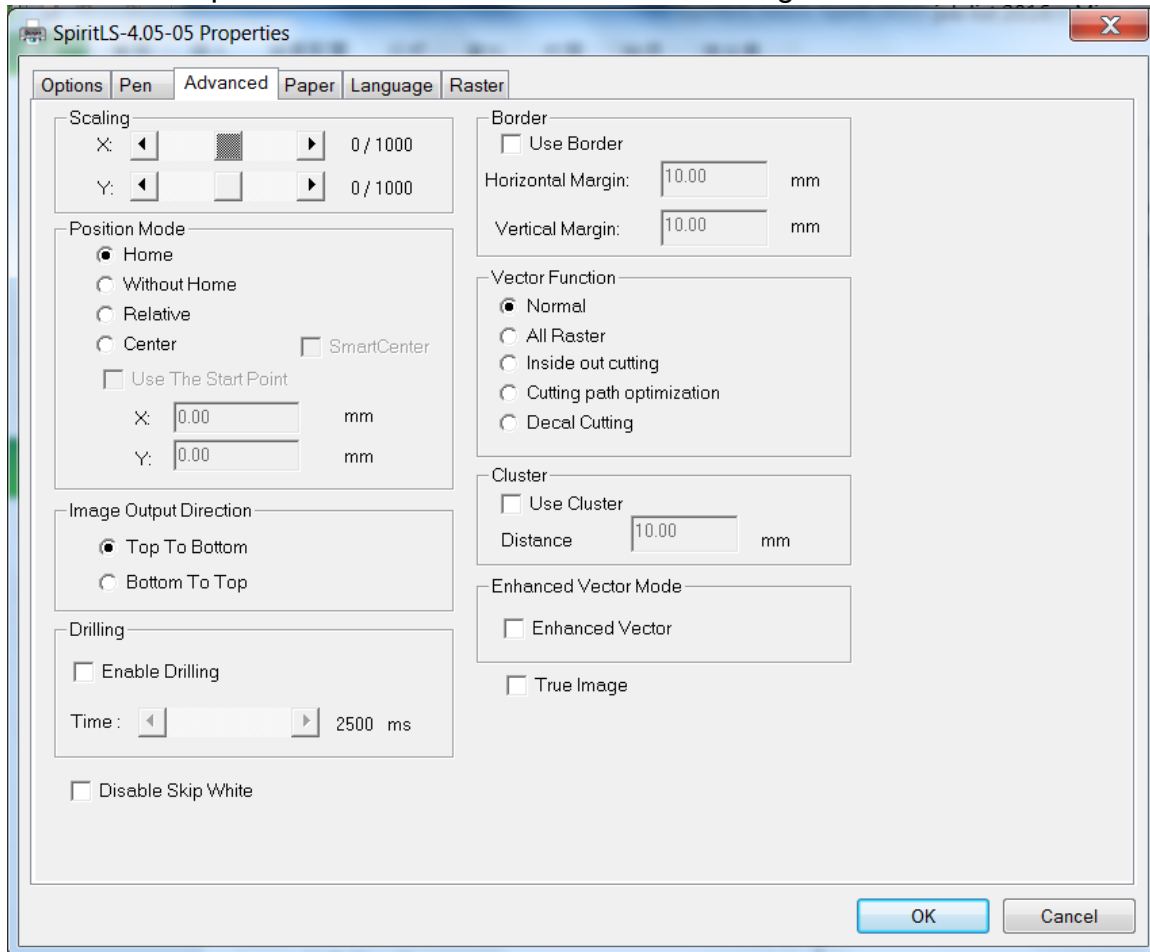

#### Scaling (Advanced Page) [DEFAULT SETTING: 0]

In some cases you may find a slight output inaccuracy in the actual output compared to what you have set in the computer. This margin of error or offset is extremely small (approximately 1/300). What this means is that there may be a 1-unit offset for every 300 unit increments. As an example, if you engrave a 300mm straight line, it may end up measuring only 299 mm or 301 mm in the final output. In this case, you will want to set the scaling setting to +1/1000 or -1/1000 respectively to compensate. A general rule of thumb is for every 300 unit increment, you will want to adjust the slider by +1 if the final output is 1 unit increment shorter or -1 if the final output is 1 unit increment longer than your graphic design setting.

#### Position Modes (Advanced Page) [DEFAULT SETTING: Home]

These selections allow you to control the positioning of the laser head after each job completion and before the next subsequent job.

- Home: Resets the positioning of the laser head to the 'home position' (upper-right) before and after each job.
- Without Home: The laser head will start the next job based on the position from its graphic application software setting, from the last position of the previous job. Upon completion of the current job, the laser head will remain at the last position of the previous job.
- Relative: This mode sets the current laser head position to correspond to the origin (top left) position of the graphic software. Therefore, the laser head will process the job from its current position relative to its setting in the graphics software.

- Center: Sets the current position of the laser head as the center point for your subsequent job. As an example, if the subsequent job is to vector cut a circle and you have the Position Mode set to Center, then the Spirit Series will vector cut a circle around the initial position of the laser head.
- SmartCENTER: The SmartCENTER function is a quick and easy way to precisely locate the center point between two points or four points.

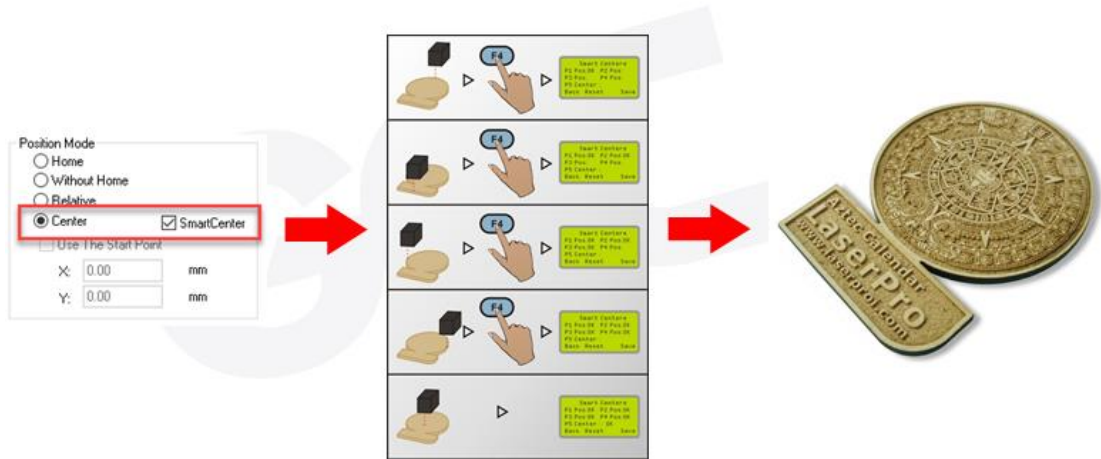

**Tip** .....

The SmartCENTER function is a quick and easy way to precisely locate the center point between two points or four points. It is a great tool for users whose jobs often require engraving on specific locations such as on award signs and plaques.

.....



**Tip** .....

It is highly recommended you enable the red dot laser pointer when setting / adjusting the Position Modes, as this will ease your job positioning with enhanced accuracy.

.....

## Image Output Direction (Advanced Page) [DEFAULT SETTING: Top to Bottom]

These selections allow you to control the direction in which the system processes an engraved image.



- Top To Bottom: Selecting this will force the system to process the current task by moving the lens carriage from the top to the bottom of the image (rear end to front end of the work table).
- Bottom To Top: Selecting this will force the system to process the current task by moving the lens carriage from the bottom to the top of the image (front end to rear end of the work table)

Normally, the LaserPro Spirit Series engraves from left to right, top to bottom. Selecting Bottom Up will alter the engraving sequence and the engraving will start from the bottom and work its way to the rear of the working table.



### Tip .....

In situations where the material you will be working with may produce a lot of dust byproducts and you are utilizing the optional air extraction system, it is recommended that you select the Bottom To Top image output direction option. This will minimize the amount of dust byproducts lodged in the engraved sections as the air extraction system is vented from the rear of the machine, the same direction as the image is processed.

## Border (Advanced Page) [DEFAULT SETTING: Unselected]

In cases where you are working with a negative image (negative outline areas of your image are engraved, rather than the positive areas), you may wish to include a border around your image. To properly add a border, you will first need to Invert your design from the Options Page, then check Use Border and specify a value for the thickness of the border you would like to add to your design. This mode is useful for engraving rubber stamps, as it allows you to create the outline around your stamp image.

### NOTE

If you wish to use the Border and Cluster function simultaneously, the Border Thickness value must be less than the Distance value specified in the Cluster setting.

## Vector Function (Advanced Page) [DEFAULT SETTING: Normal]

- Normal: This selection will not apply any special advanced vector function to your job. This is the default Vector Function setting.
- All Raster Output: This selection will instruct the print driver to process your entire image as a raster engraving. Any vector lines within the image will be treated as raster data and outputted as a raster engraving, similar to a dot-matrix printer.

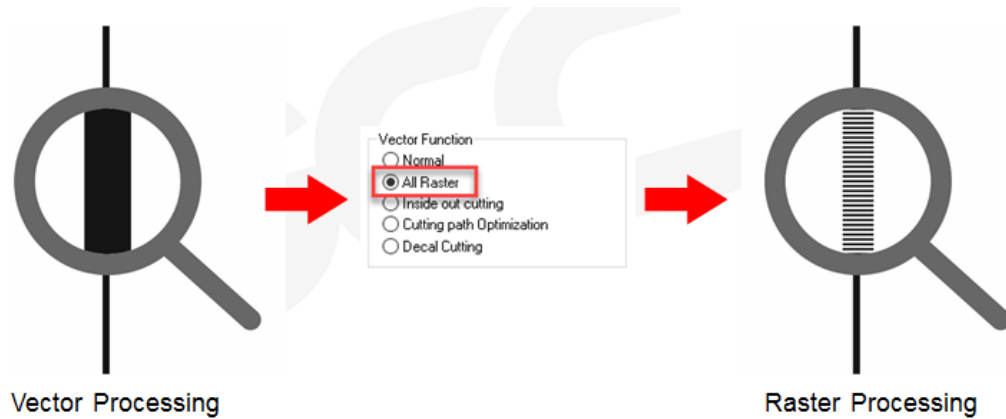

- Vector Sorting: When performing a vector cutting job in which your image has one vector cut area enclosed within another vector cut area, select the Vector Sorting mode. This mode will automatically instruct the print driver to process the inside vector image and moving outwards. If you try to process a vector image that has multiple layers without using this mode, what may occur is the laser engraver may process the outer vector cutting first, and any inner vector cutting will not be possible as your centerpiece material may have dropped to the cutting table. This setting will always automatically direct the laser to cut from the inner most vector shape and move outwards.
- Inside out Cutting: This setting will always automatically direct the laser to cut from the inner most vector shape and move outwards.



- Optimization Sorting: This is a setting that will minimize your process time. When selected, the print driver will analyze your image and automatically determine the most efficient processing path to process your image.

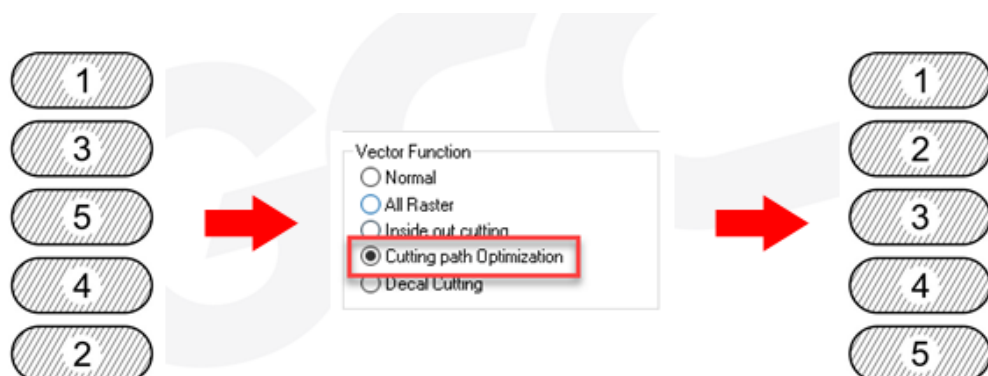

- Decal Cutting: this function is developing to reduce material weeding job after laser cutting for multiple layers adhesive materials, such as lettering vinyl, heat transfer film, and twill film. This function allows allocating different parameters for corresponding decal layer numbers to do die cut (cut through media) for the unwanted parts, and kiss-cut (half cut) for the kept material parts, after the laser cutting, users can just peel off the materials to get rid of waste parts.



Visit GCC LaserPro Youtube channel for decal cutting introduction video at <https://www.youtube.com/watch?v=YgGTMHqtWqE&feature=youtu.be>

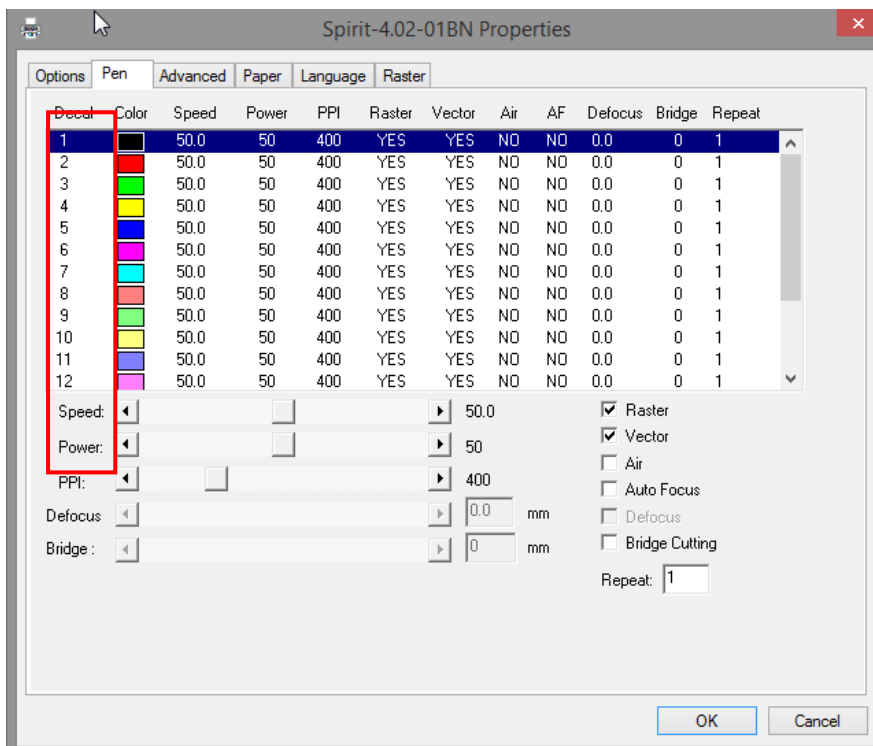
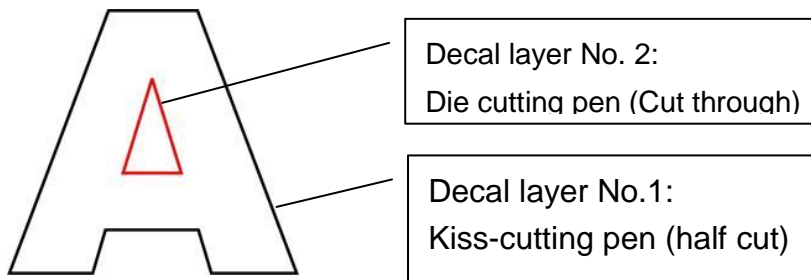

### Enhanced Vector Mode (Advanced Page) [DEFAULT SETTING: Unselected]

This setting allows you to improve the cutting quality at the expense of speed. Your engraving speed will be dropped by 50%, to maximize the cutting power. We recommend that you enable this function when cutting thicker materials.

### Drilling (Advanced Page)

The drilling function is available only for use with AutoCad. Users can insert dots from AutoCad's tool bar and use the drilling function to set the drilling time required to create holes.

Use the default "dot" tool (  ) from the tool bar to create dots which will be interpreted as drilling locations.

Use the adjusting bar on under the "Drilling" function to set the drilling time (spot delay) required. The size of the drilled hole can be adjusted by deploying a longer or shorter drilling time.

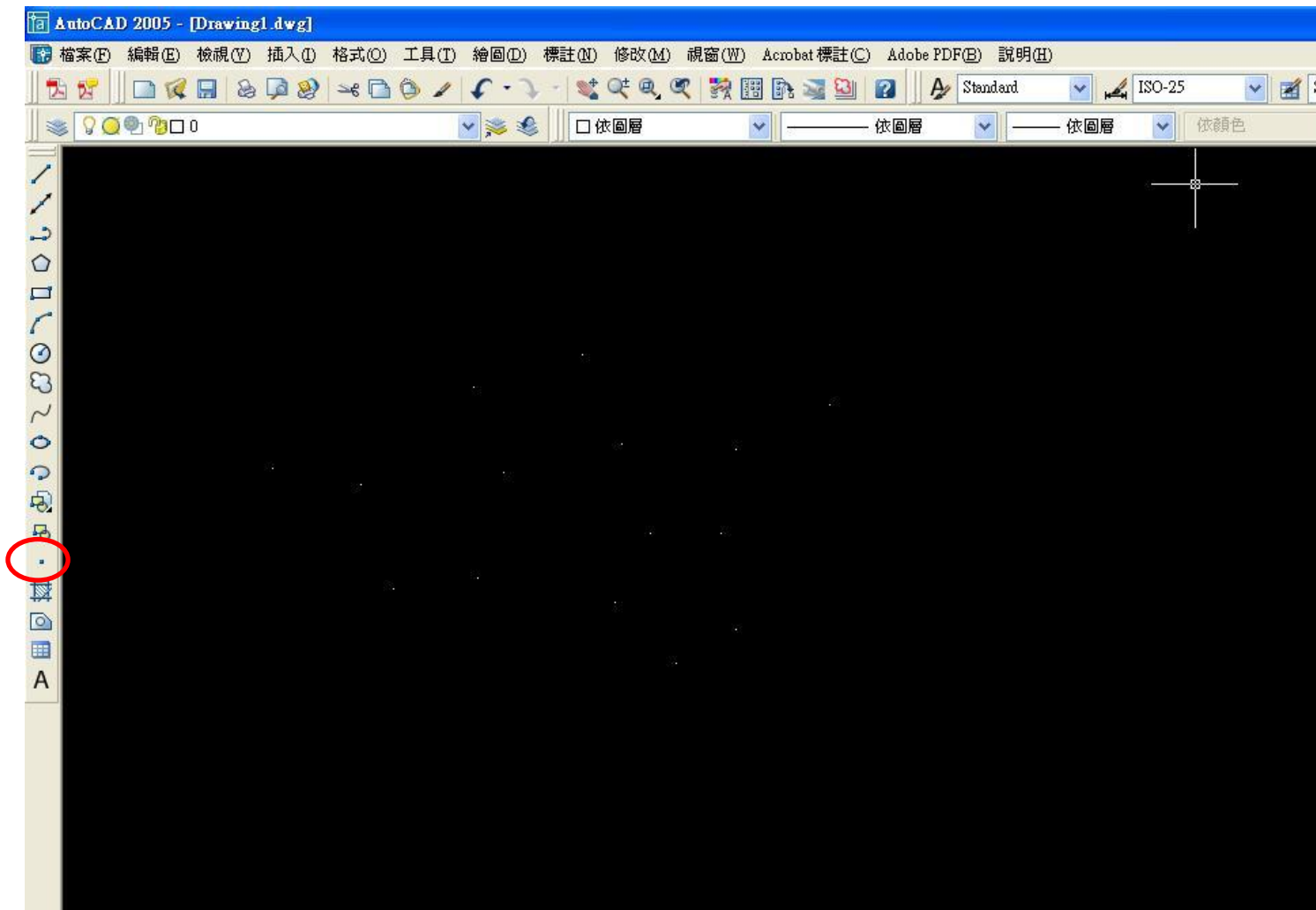

### Use Cluster (Advanced Page) [DEFAULT SETTING: Unselected]

This setting allows you to change how the Spirit interprets and processes individual / independent areas of an image in order to minimize job-processing times. The Cluster function is only applicable when multiple areas of an image are broken down and isolated from each other (areas not touching each other, blank space in-between). Another condition that must be met for the Cluster function is that these individual areas of your design must have some X-axis overlap, meaning that they should be to some extent side-by-side with empty spaces between them. The distance value can be set by the user and represents the limit or cutoff point in which side-by-side objects will be processed in Cluster mode or not. If the distance between side-by-side objects is

greater than the set distance value, then the individual areas will be processed in Cluster mode. Conversely, if the distance between side-by-side objects is lesser than the set distance value, then the individual areas will be processed normally (not via Cluster mode).

An example of an image that would benefit from the Cluster function would be: 2 squares to be engraved, side-by-side on the X-axis with a 20 cm gap in between them. In this scenario, you would want to enable the Cluster setting and set the distance to a value less than 20. By doing so, the laser will completely process one square and “leap-frog” to the second square, rather than processing both squares simultaneously. The resulting processing time is minimized by eliminating the unnecessary travel distance the laser head needs to make across the X-axis in between squares, if they were to be processed simultaneously.

## NOTE

If you wish to use the Border and Cluster function simultaneously, then the Border Thickness value must be less than the Distance value specified in the Cluster setting.

## True Image Mode (Advance Page) [DEFAULT SETTING: Unselected]

This setting allows you to improve the engraving quality by reordering the line by line output sequence and by doing so masking the banding problems. This feature is only suitable for engraving large sized graphics. Note: The overall working time will be increased.

True Image is a function that will shuffle the normal engraving sequence to produces a nicer engraving output by reducing possible banding occurrences.

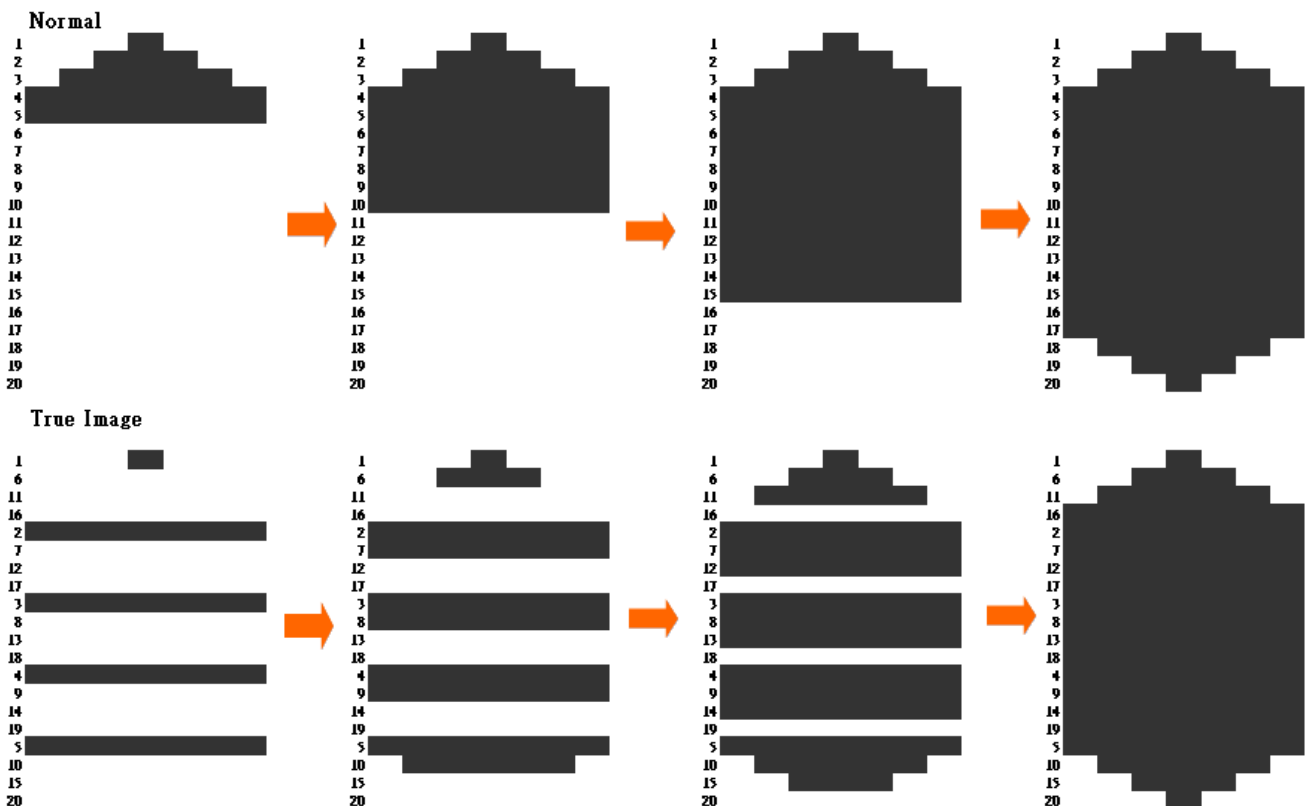



### 5.2.3.4 Spirit Series Print Driver >> Paper Page

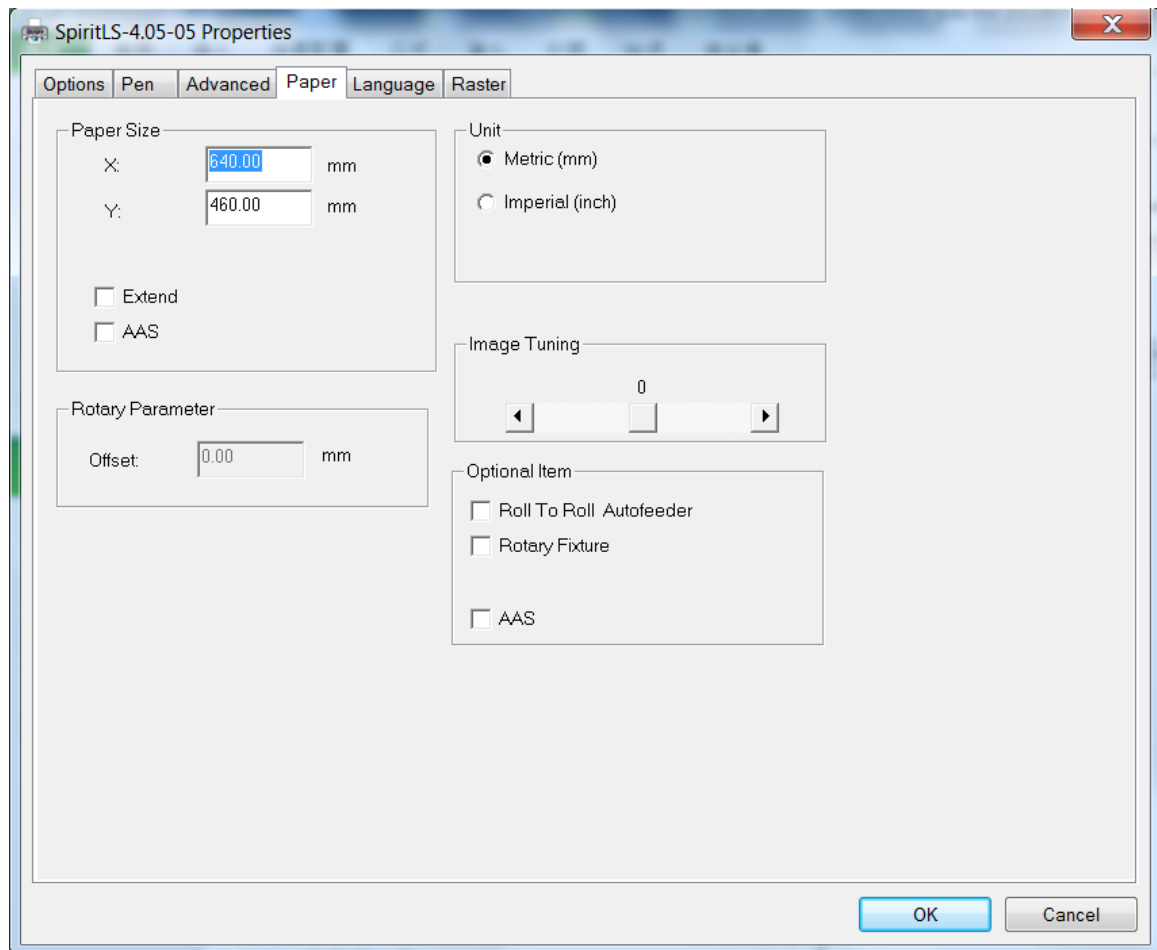

#### Paper Size (Paper Page)

The paper size represents your total work area. Ensure that the paper size is never set greater than the working area. The X value represents the length and the Y value represents the width.

GCC Laser System	Spirit	Spirit LS	Spirit GLS	Spirit GLS Hybrid
Working Area	25"x18" (640x460 mm)	25"x18" (640x460 mm)	34"x24" (860 x 610 mm)	34"x24" (860 x 610 mm)
Extended Working Area*	29"x18" (740 x 460 mm)	29"x18" (740 x 460 mm)	38"x24" (960 x 610 mm)	38"x24" (960 x 610 mm)

\* when Extend option is checked in Paper Page

#### NOTE

When using the optional rotary attachment system and with the Rotary Fixture option checked, the X value represents the length of your working piece. The Y value will be changed to Diameter, which represents the diameter of your working piece (at the position you wish to engrave).

#### Unit (Paper Page) [DEFAULT SETTING: Metric (mm)]

Here you can set your preferred measurement standard in which you would like to use with the Spirit Series print driver. You can choose between metric or imperial standards.

#### Image Tuning (Paper Page) [DEFAULT SETTING: 0]

In the event that you are processing extremely fine and detailed designs requiring near-microscopic edge-to-edge precision, you will need to adjust the image tuning setting. To adjust this setting, we recommend that you engrave a small black square design as a sample and use a magnifying glass to view the engraved results.

When you look at your engraved test square under a magnifying glass, you may notice the edges of your square may be slightly offset, with every consecutive engraved even or odd line protruding past the square's ideal edge. This occurrence may occur on the left or right side of the square and can be compensated for by the image tuning setting. In the diagram below, the arrows refer to the direction the laser head is moving to generate that engraved line. If the first and every other line protrude to the left of the square's ideal edge, you will want to set the image tuning to a negative value. If the first and every other consecutive line protrude to the right of the square's ideal edge, you will want to set the image tuning to a positive value. The further the protruding lines are from the square's ideal edge, the larger you will need to set the Image Tuning value to compensate.

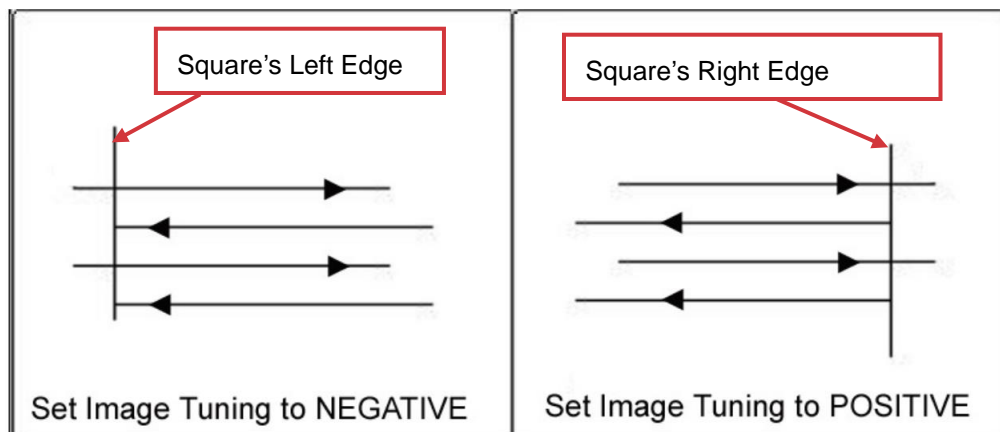

The following is an example that has the proper image tuning, and demonstrates this significance when engraving fine, small, intricate text. The following two pictures show engraved text magnified with no image tuning (left picture) and image tuning enabled (right picture).



#### Extend (Paper Page) [DEFAULT SETTING: Unselected]

If you are processing a very large area requiring the maximum work table area, you will want to enable this mode. Enabling this mode will extend the Spirit maximum work area to 29" x 18" (740 mm x 460 mm) from the default 25.197" x 18.110" (640 mm x 460 mm), Spirit LS maximum work area from 25"x18" (640x470mm) to 29"x18"(740x460mm), and Spirit GLS maximum work area from 33.8"x24" (860x610mm) to 37.8"x24" (960x610mm). This function is enabled at the expense of some quality loss, usually on the left and right edges of your full-size engraving. Usually the quality loss is minimal and may not be apparent, depending on your design.

## NOTE

With the Extend function enabled, the following functions are disabled: 3D mode (Options Page), Stamp Mode (Options Page), SmartACT (Options Page), Disable Skip White (Advanced), Auto Focus (Pen Page), and Rotary Fixture (Paper Page).

### Rotary Fixture (Paper Page) [DEFAULT SETTING: Unselected]

## NOTE

This option is only to be used with the Rotary Attachment optional accessory properly set up. For instructions on how to set up the Rotary Attachment, please refer to Chapter VII of this manual.

You will need to select this option when processing a job with the optional rotary attachment system to engrave on round or cylindrical objects. When you have your material and rotary attachment properly set up:

- 1) Check the Rotary Fixture function and notice the change in the Paper Size fields under Paper Size, the X value represents the length of your work piece. Enter the length of your work piece in this field.
- 2) Under Paper Size, the Diameter value represents the diameter of your working piece (at the position you wish to engrave). Enter the diameter of your work piece in this field. Again, remember the proper diameter value would be the diameter location, at the point of engraving on your work piece.
- 3) Under Rotary Parameter, the Offset value represents distance from the open end of your work piece to the base of the padded rubber wheel. This value will be displayed on the LCD panel. Enter the proper offset value in this field.

### Roll to Roll Autofeeder\* (Paper Page) [DEFAULT SETTING: Unselected]

This option is only to be used with the Roll to Roll Autofeeder optional accessory properly set up. The Roll to Roll Autofeeder function is allow laser system to work with roll media continuously, when laser machine finishes the work, the Roll to Roll Autofeeder will automatically to wind up the processed materials and load another frame of unprocessed materials for laser processing. For instructions on how to set up and operate the Roll to Roll Autofeeder, please refer to its accessory manual along its package.

Noted Roll to Roll Autofeeder is only available for CO2 laser system (Spirit, Spirit LS, and Spirit GLS), not compatible for Spirit GLS Hybrid dual lasers configuration.

### AAS\* (Paper Page) [DEFAULT SETTING: Unselected]

This option is only to be used with the AAS optional accessory properly set up. The AAS optional module allow you to laser contour cut the printed image, the AAS module will find the registration marks printed around the image, and position the laser contour cutting line automatically. For instructions on how to operate the AAS, please refer to its manual along with package.

Noted AAS module is only available for CO2 laser system (Spirit, Spirit LS, and Spirit GLS), not compatible for Spirit GLS Hybrid dual lasers configuration.

## NOTE

1. This option is only to be used with the AAS optional accessory properly set up.
2. When activate AAS selection in print driver, the paper size will be reduced.

### 5.2.3.5 Spirit Series Print Driver >> Language Page

This page allows you to specify the language displayed by the Spirit Series Print Driver. Current language options allow for: English, Spanish, French, Chinese (Simplified, Traditional), Japanese, and German. Remember to select “Save to Default” on Options Page to save the specified language.

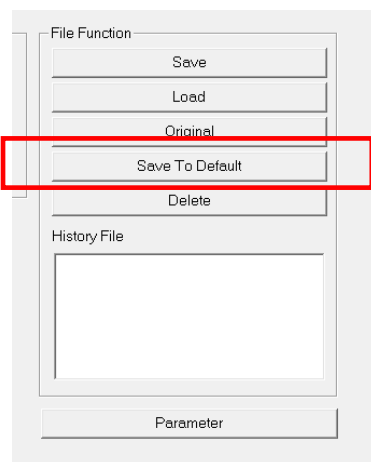
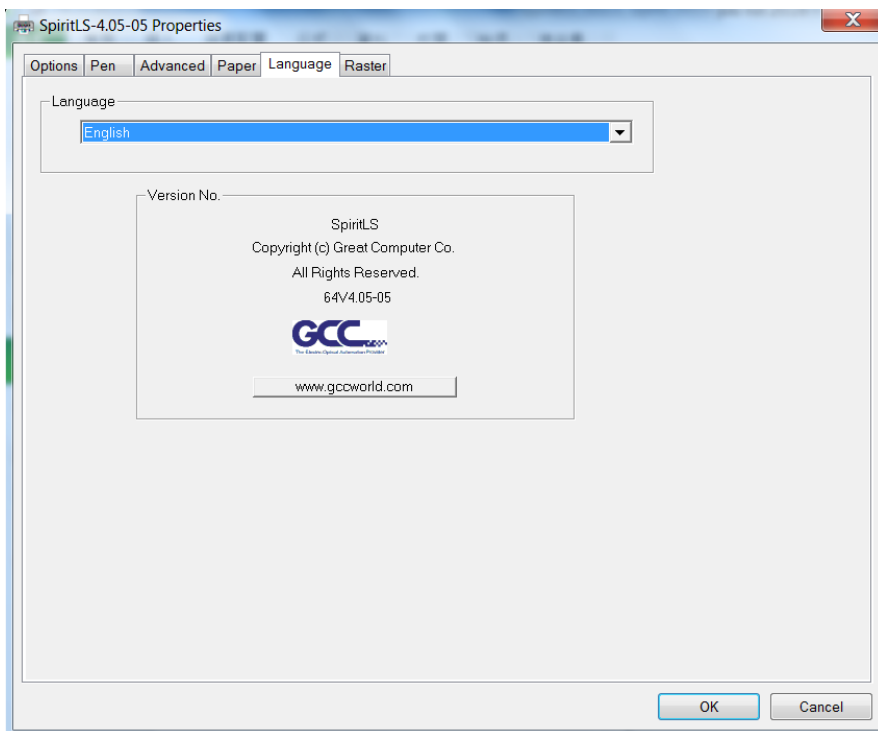

### 5.2.3.6 Spirit Series Print Driver >> Raster Page

#### NOTE

The Raster Page is only available when Black & White Mode Setting is selected from the Options Page, this page offers a number of advanced Raster Engraving output options.

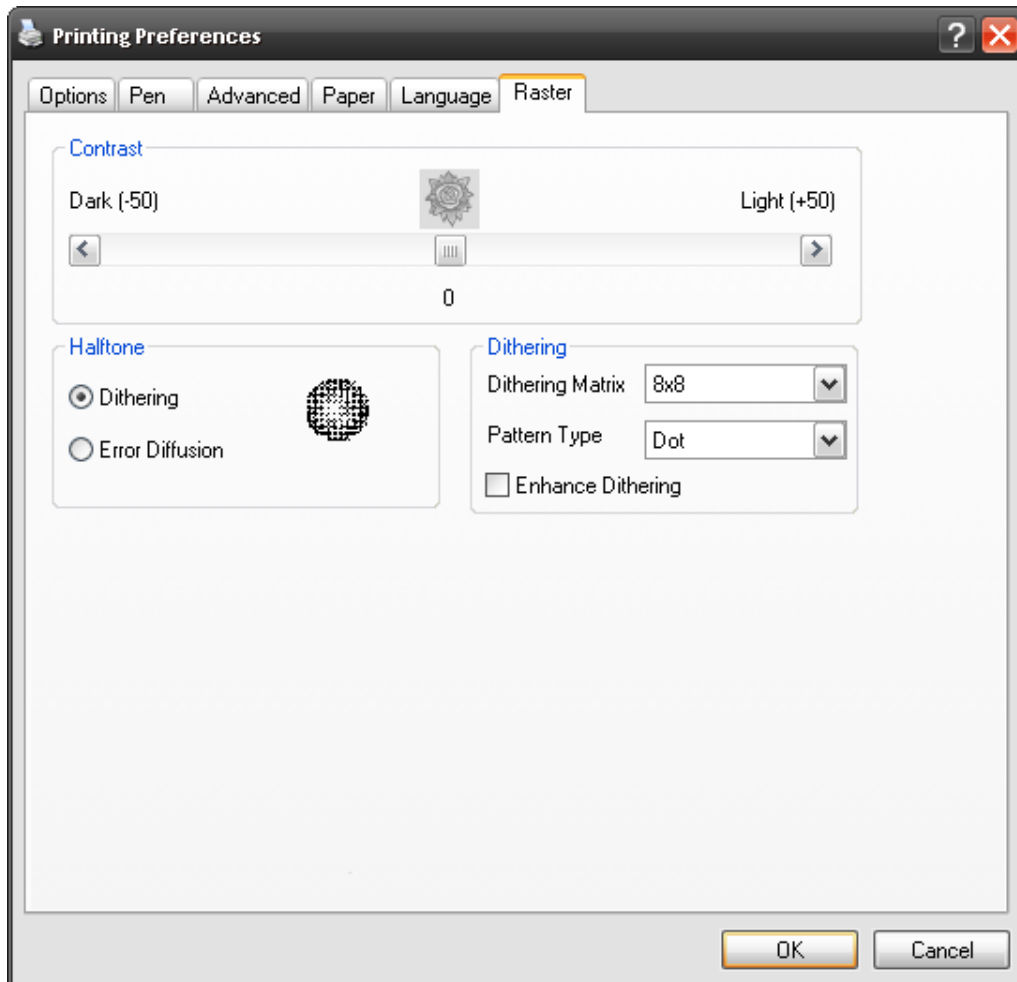

#### Contrast (Raster Page) [DEFAULT SETTING: 0]

This provides a quick and easy way to immediately adjust the contrast of an engraved image. Moving the slider to the Dark setting will increase the contrast levels of the engraved output, whereas moving the slider to the Light setting will decrease the contrast levels of the engraved output.



#### Tip .....

There are other ways to adjust an engraved image's contrast such as: adjust the power / speed settings or simply adjust the contrast of the image in software with the graphic software application.

.....

## Halftone (Raster Page) [DEFAULT SETTING: Dithering]

This option controls the way a raster-engraved image is processed. The “digital image to engraved output” process can be processed via two methods: Dithering or Error Diffusion. Each offer additional output options yielding different output effects, style, and quality.

- Dithering: Interprets and outputs the raster engraving via the dithering method. This mode will allow you to select the Pattern Type and Dithering Matrix, and Enhanced Dithering.

- Pattern Type: Dot, Bayer, Corner, 45 Degree [DEFAULT SETTING: Dot]

Each pattern type uses a different shape and arrangement of dots to compose the shading effect of a raster image.

The following diagram is an example of the raster effects when using the different pattern types.

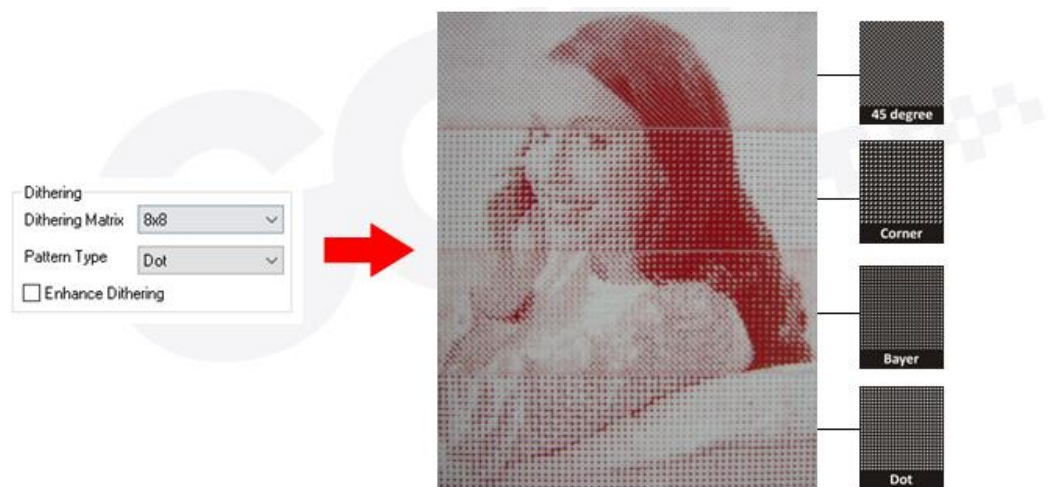

- Dithering Matrix: Variable depending on the Pattern Type selected. [DEFAULT SETTING: 8x8]

This controls the resolution (dot size) and the number of dots the image is broken down into for the dithering process. As an example, selecting 2 x 2 will shade with a 5-grade halftone, where as an 8 x 8 Dithering Matrix will dither with a 65-grade halftone.

The following diagram is an example of the raster effects when using the different dithering matrices.

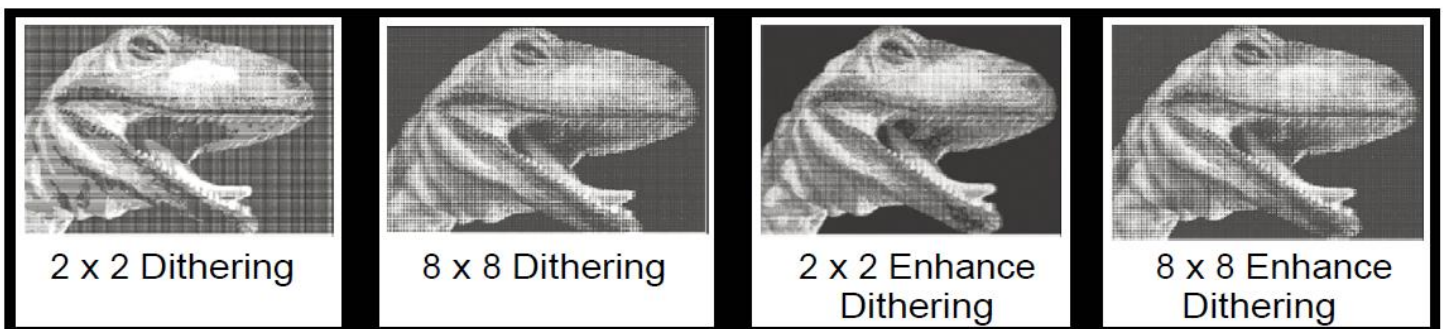

- Enhance Dithering [DEFAULT SETTING: Unselected]

Selecting this will produce a finer dithering output.

- Error Diffusion (Raster Page): Interprets and outputs the raster engraving via the error diffusion method. This mode will allow you to select from three diffusion types: Floyd, Stucki, and Jarvis.
- Diffusion Type: Floyd, Stucki, Jarvis [DEFAULT SETTING: Floyd]

Each diffusion type presents the shade of image as different spread halftones instead of dots to compose a raster image.

The following diagram is an example of the raster effects when using the different diffusion types.

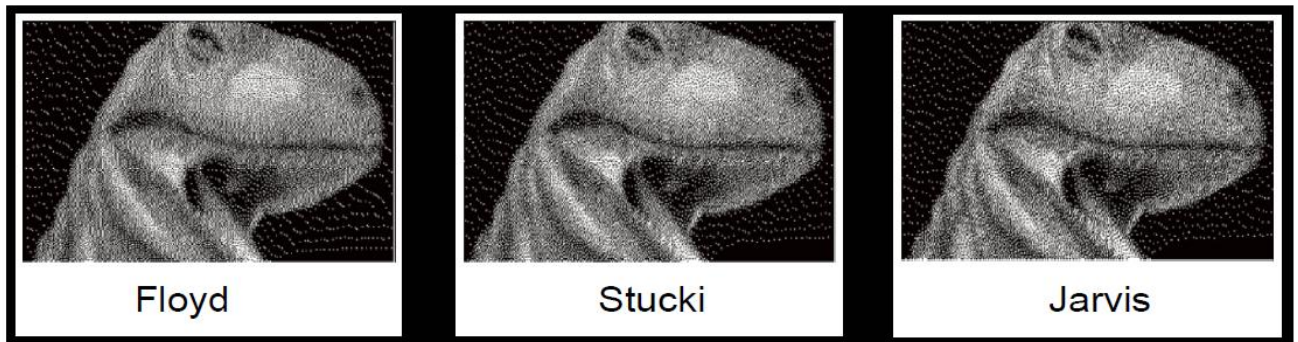

**Tip** .....

There is no “correct” or “best” setting when using the Raster options. The most appropriate settings will be based on a variety of factors: your design, the material you are engraving on, and the results you wish to achieve, etc. Please take some time to experiment with the multitude of raster options to get the one you feel is the best for your piece. This is where much of the fun in engraving is....experimentation!

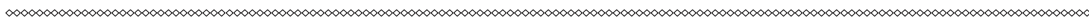

### 5.2.3.7 Spirit Series Print Driver >> Stamp Page

Producing stamps require different operational steps than your standard engraving or cutting jobs. The Stamp page offers dynamic options allowing you to customize your stamp production process.

Noted Stamp function is only suitable for CO2 laser system (Spirit, Spirit LS, and Spirit GLS), not suitable for Spirit GLS Hybrid dual lasers configuration.

#### NOTE

The Stamp page will only appear and be accessible when you have selected the Stamp Mode from the Options Page.



#### Tip

Functions located on the other pages that are useful when making a stamp: Set Shoulder, Pitch, Border, Invert, and Mirror.

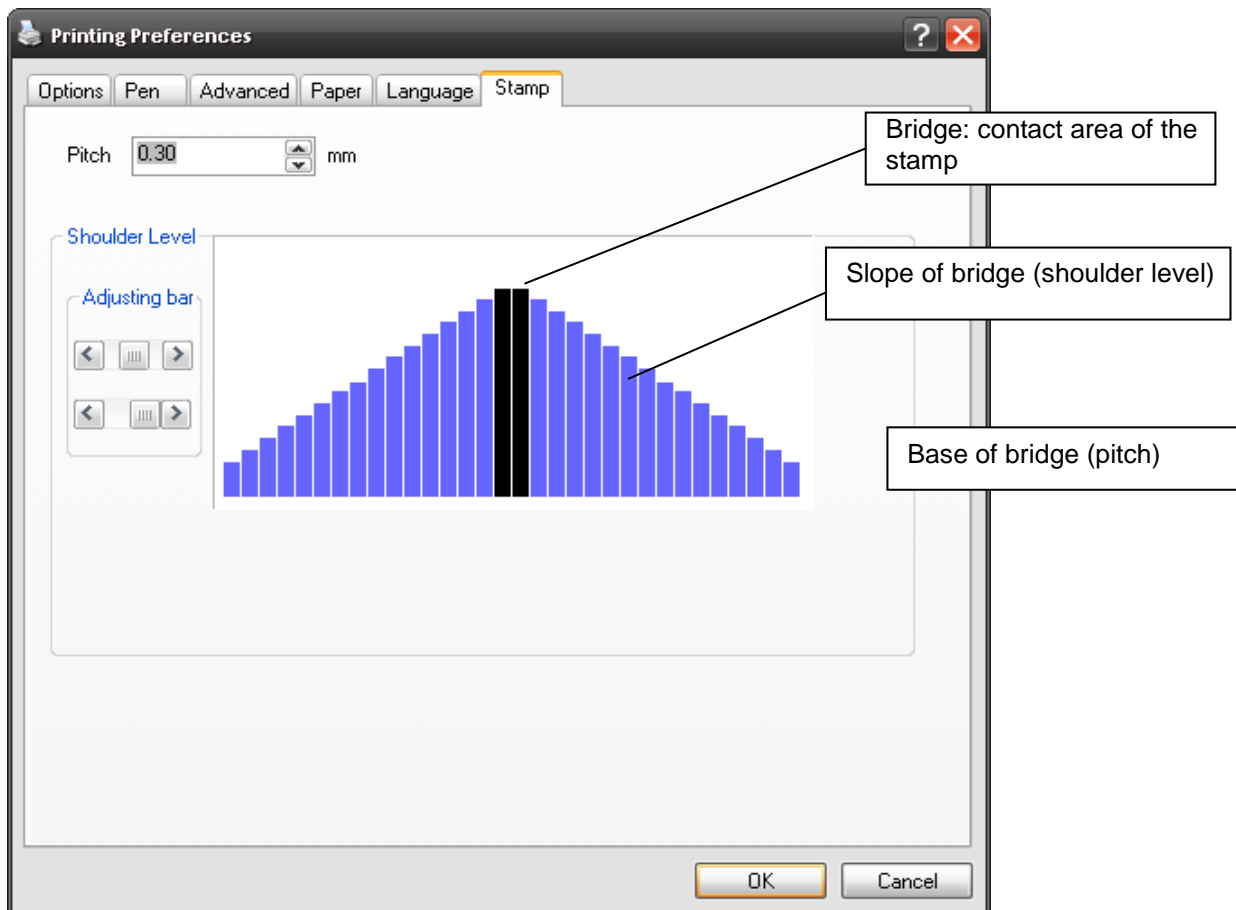

#### Pitch (Stamp Page)

Your stamp will be a reversed image composed of engraved depressions and ridges. Think of these ridges as the “contact sections” of the stamp. If the ridges of these contact sections are too thin, they may break. The Pitch setting allows you to increase the width of the ridge base, hence creating more stable “contact sections” and longer lasting stamp. The pitch value setting allows



you to adjust the base width of the ridge. Broad pitch gives the maximum amount of support for each ridge. Experiment with different pitch value settings in order to produce the stamp that is best suited for your application.

### Adjustment Bar/ Power Level (Stamp Page)

Another important aspect of creating a stamp is setting the slope level of the shoulder. The shoulder is the section from the “contact section” of the stamp to its base. This function allows you to adjust the slope for the shoulder sections of your stamp. By sliding the sliders or directly input of power levels, you will be able to change the slope of the shoulder.

#### NOTE

The visual representations of the Pitch and Shoulder Levels in the Spirit Series driver are an exaggerated representation to allow for easy visual guidance and precise input. Remember we are working with distances less than 1 mm here.

# 6

Chapter 6

---

## Engraving and Cutting Techniques

Raster Engraving

Vector Cutting

Vector and Raster

3D Tips

Modify Image Setting of a Picture for Better  
Engraving Quality

## 6.1 Raster Engraving

A CO2 laser engraver can process text, scanned image, digital picture, or design by “laser firing” grids /dots of individual pixels into a raster image. Think of this as simply “printing” your job onto any particular material. An example of a raster engraved piece would be a photo engraving on tile, as shown in the picture below.



## 6.2 Vector Cutting

A CO2 laser engraver can process text, design, and images composed of lines through continuous-firing of the laser to cut out various shapes. When performing vector cutting operations, imagine the laser head as a pair of scissors cutting out the lines specified in your design. An example of a vector cut piece would be a customized dining mat, as shown in the picture below.



The Spirit Series Print Driver determines which sections should be raster engraved or vector cut based on the outline width of that particular area or section of the design. In order to prep a particular section for vector cutting, you will need to set that object's fill color to white and set its outline thickness between 0.001" (0.025 mm) to 0.004" (0.1 mm) via the graphics software.

Below is an example of how to prep an area (in this case, we will use a section of text) for vector cutting. CorelDRAW will be used as the selected graphics software.

- 1) With the text function, create a string of characters and select those characters by clicking on the text.

- 2) Change the text fill color of the selected characters to white by left clicking on the white color from the CorelDRAW Color Palette (located on the right hand side of the screen)
- 3) Change the outline color of the selected characters outline by right clicking on the desired color from the CorelDRAW Color Palette.
- 4) Change the selected characters outline thickness to the thinnest width by right clicking on the selected text select <Properties> → Click on the <Outline> tab and change the Width to its thinnest dimension. Click on “OK” to apply the changes.
- 5) Now your string of characters has been properly designated as an area to be vector cut. Simply “print” your job (output the file to the Spirit Series) and watch as your string of characters is vector cut.

### 6.3 Vector and Raster

In some cases, you will want to process both raster engraving and vector cutting tasks within a single project. For example, if you wanted to engrave a design onto a particular material and then cut a particular shape around that engraving. The picture below is an example of engraving on a piece of leather which has then been cut out: The picture below is an example of an engraving on a piece of cork, which has then been cut out with a square shape:



In these situations when there are raster engraving and vector cutting operations on a single project, the LaserPro Spirit Series driver will interpret between raster sections and vector sections by the types of lines and line widths of your design. Areas of your design with line widths set between 0.001" (0.025 mm), 0.004" (0.1 mm) will be designated for vector cutting, and the other areas will be designated for raster engraving.

### 6.4 Hybrid Laser Engraving, Cutting, Marking (only for Spirit GLS Hybrid with dual lasers configuration)

Spirit GLS Hybrid model with dual lasers configuration can process engraving, cutting, and marking on organic materials and metals. Specify different laser type to different Pen No. on GCC print driver, then Spirit GLS Hybrid machine will automatically switch different laser source between jobs. Here we use a knife as an illustration.

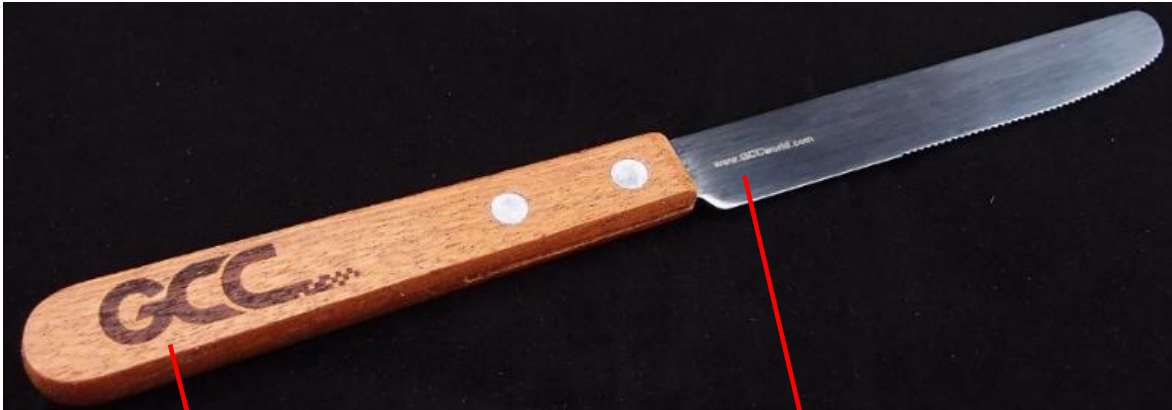

Laser Engraving with  
CO2 laser

Laser Marking with  
fiber laser



Step 1. Assign different colors to the graphics to be processed by different laser tubes in graphic softwares like Corel Draw, Photoshop, and Illustrator. Example here is the graphic for CO2 laser processing in black color, and Red for fiber laser processed graphics.



Step 2. Go to Pen Page of Spirit GLS Hybrid print driver. The default laser type for each pen is CO2 Laser, leave Pen 1 (Black Pen) as default, while change Pen 2 (Red Pen) to Fiber Laser, and enable AutoFocus function for Pen 2 to have laser system re-do focusing when working on where has different surface level to Pen 1 (CO2 laser).

Step 3. Print the file from print driver to Spirit GLS Hybrid machine.

Pen No.	Color	Speed	Power	Freq	Raster	Vector	Air	AF	PPI	Defocus	Repeat	waveform	Laser
1	Black	50.0	50	30	YES	YES	NO	NO	400	0.0	1	0	CO2
2	Red	50.0	50	30	YES	YES	NO	YES	400	0.0	1	1	Fiber
3	Green	50.0	50	30	YES	YES	NO	NO	400	0.0	1	0	CO2
4	Yellow	50.0	50	30	YES	YES	NO	NO	400	0.0	1	0	CO2
5	Blue	50.0	50	30	YES	YES	NO	NO	400	0.0	1	0	CO2
6	Magenta	50.0	50	30	YES	YES	NO	NO	400	0.0	1	0	CO2
7	Cyan	50.0	50	30	YES	YES	NO	NO	400	0.0	1	0	CO2
8	Orange	50.0	50	30	YES	YES	NO	NO	400	0.0	1	0	CO2
9	Light Green	50.0	50	30	YES	YES	NO	NO	400	0.0	1	0	CO2
10	Light Yellow	50.0	50	30	YES	YES	NO	NO	400	0.0	1	0	CO2
11	Light Blue	50.0	50	30	YES	YES	NO	NO	400	0.0	1	0	CO2
12	Light Purple	50.0	50	30	YES	YES	NO	NO	400	0.0	1	0	CO2

Speed: < [Slider] > 50.0

Power: < [Slider] > 50

Freq: < [Slider] > 30

PPI: < [Slider] > 400

Defocus: < [Slider] > 0.0 mm

Raster  
 Vector  
 Air  
 Auto Focus  
 Defocus  
 Waveform  
 Fiber Laser  
 Repeat: 1

Step 4. Manually move the lens carriage of laser machine to where wants to processed by CO2 laser and press AutoFocus button on control panel.

Step 5. Press START button on control panel to begin laser jobs.

Step 6. The lens carriage will move to holder of knife for Pen 1 (CO2 laser) processing, and move to blade section to do AutoFocus again then start Pen 2 (Fiber laser) processing.

## 6.5 3D Tips

3D Mode is one of the functions of GCC CO2 laser engraver. Instead of traditional two dimensional graphic processing, 3D Mode allows the naked eyes to visualize the curvatures of the 3D effect by applying 200 power levels technology to create different depth of engraving. Although it is easy to produce 3D samples with LaserPro Engraver, production of the 3D graphic can be a hassle for our users.

### Principle for 3D production by laser

3D processing uses degrees of the gray level to adjust the output energy of the laser. Take the figures below as an example. When the color of a certain block is set as 100% black, the laser output energy for processing will be at 100%. The processing depth will be fairly deep. When the gray level is set as 50% black, the laser output energy will be adjusted to a smaller value accordingly so that the processing depth is not as deep.

By specifying the degrees of the gray level in this way, various energy output is achieved and the 3D effects are produced.

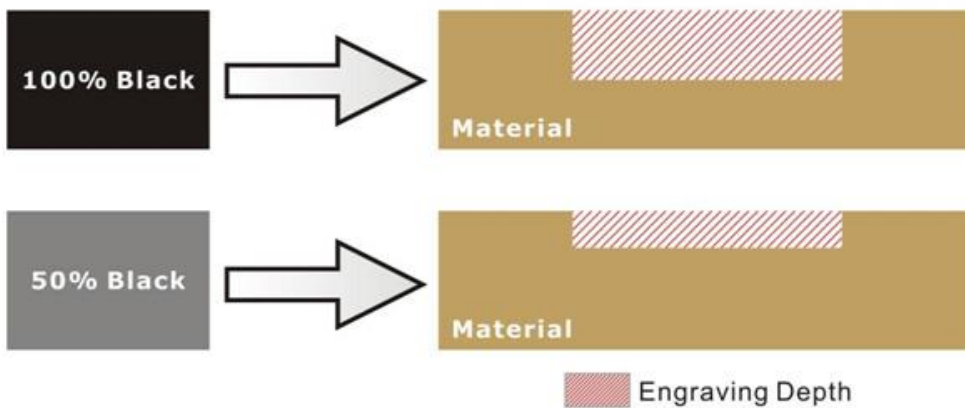

By specifying different levels of black in design software, the corresponding laser power energy will generate different depths of engraving result.

## Introduction to software for 3D graphic production

Many ways to produce 3D graphics are available. If you are familiar with or frequently use one of the 3D software in the market like Laser Type, EngraveLab, 3D Studio etc., you may use it for the production of 3D graphics. After completion, save the 3D images as one of the formats that is compatible with the Laser Engraver (such as JPG or BMP) and let the machine begin the engraving. If you are not familiar with any 3D software, some editing software specific for laser in the market also have 3D mode functionality, which could be a handy tool for you to produce 3D objects. Of course, you may also use Photoshop or CorelDRAW, which you might be using on daily basis, for the production of 3D objects. Ways to produce 3D graphics with these software are not the same. In the following section, we will give you simple illustrations with respect to how these software work.

## Laser Professional AP

Currently, quite few laser professional application softwares like Laser Type, 3D studio, EngraveLab are available in the market. You can not only create all kinds of vector images with these AP but also convert these vector images into 3D module, which is a great way to produce 3D graphics.

As illustrated in the figure below, all you need to do is to choose the direction of the vector and then set the length and shape of the convex or concave surface. The software will automatically generate the 3D graphic for you.

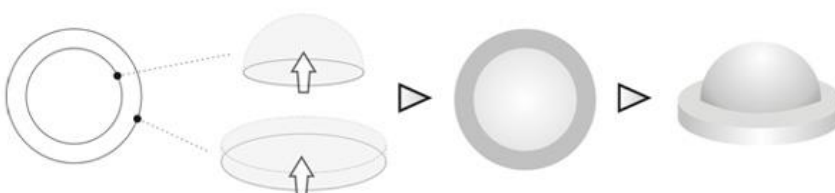

## Concept illustration of 3D graphic production with Laser Professional AP

After the graphic is completed, you can output the 3D graphic directly to the laser machine through GCC LaserPro driver, which is very handy. Or you can also export the 3D graphics as JPG or BMP format and edit with frequently used CorelDRAW or Illustrator software, then output the graphic to GCC laser system.

### Photoshop & CorelDRAW

The way to produce 3D graphics with Photoshop and CorelDRAW is very similar. Fill in the desired gray level colors to each of the drawn figures, and proceed with further arrangement and combination. Then you may output the 3D graphic to the laser for the production of the 3D object. Take the figure below as an example. After producing two graphs in gray level, proceed with the arrangement and combination. Then you may let the laser proceed with 3D mode.

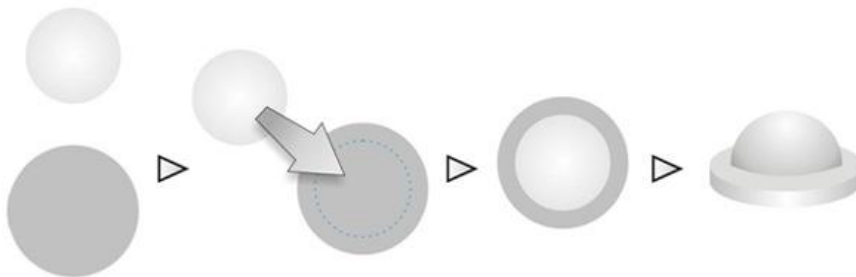

Both Photoshop and CorelDRAW may produce 3D graphics in the manner of combination.

### A way to produce 3D graphics

For the production of 3D graphics, in addition to the requirement of having great familiarity with the software, a significant amount of time is required to design and arrange the layout. Thus, we use a relatively simple graphic for illustration so that you would understand how to produce 3D graphics better.



Take the graphic above as a production example. CorelDRAW is used for the production of the 3D graphic.

#### Step 1. Produce the gray level background



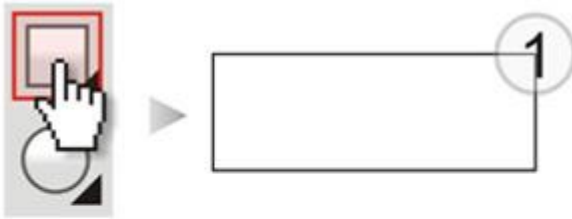

▲ Draw a rectangular box with the drawing tool



▲ Select Fountain Fill to fill in the gray level

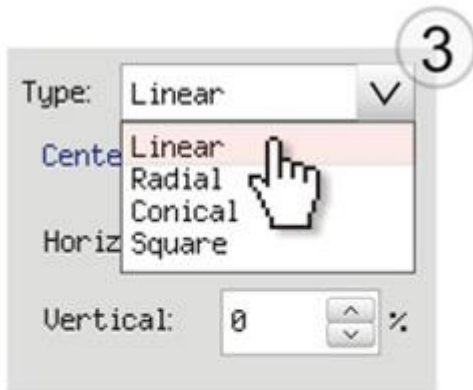

▲ Select Linear as the type of the gray level

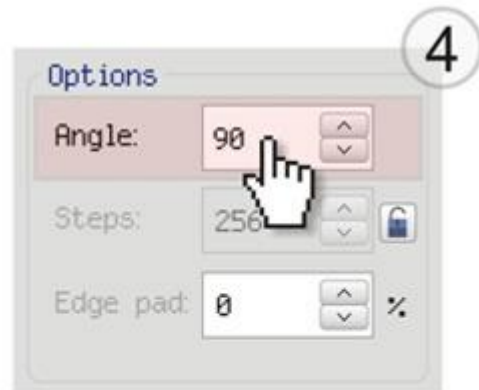

▲ Set the gray level angle as 90 degrees

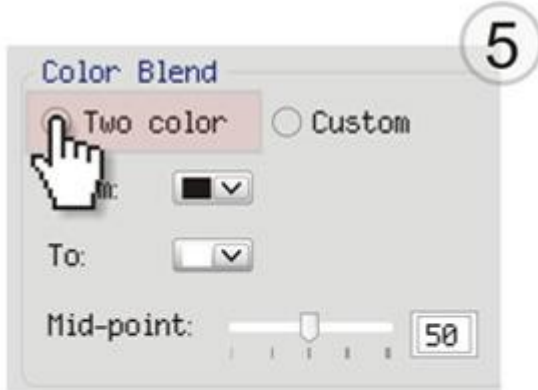

▲ Select Two color as the type of the gray level

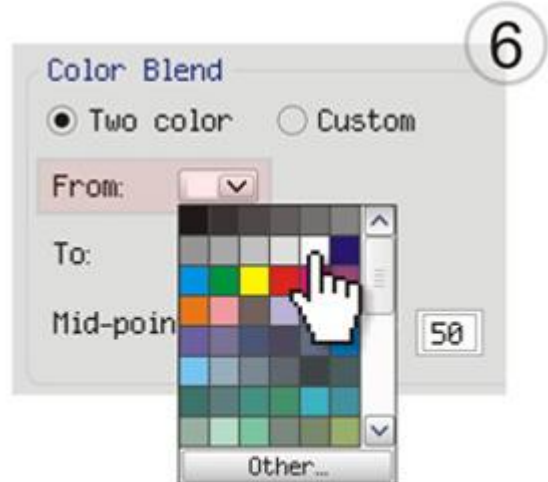

▲ Set the From color as 0% Black



▲Set the To color as 100% Black

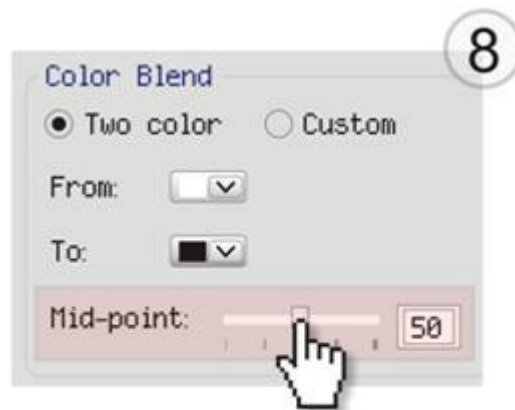

▲Set the Mid-point as 30



▲Click OK to complete the editing



▲A gray level graphic is finished

### LaserPro requests your attention

If you need to produce circular 3D graphics, you only need to select Radial as the gray level type in the pull-down menu of Type. Then, a circular 3D graphic may be produced.

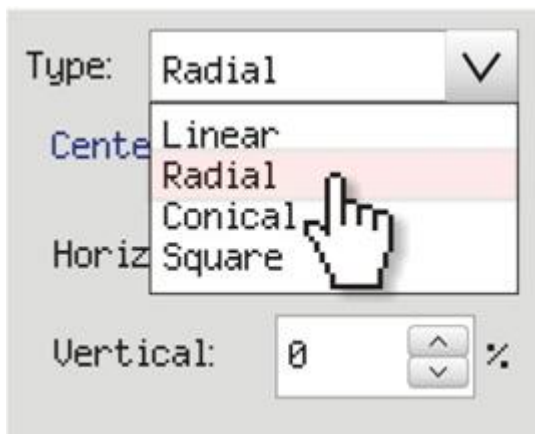

Step 2. Produce three-dimensional characters



▲Edit the word with the Text toolbox



▲Use the Color toolbox on the right to fill the white color into the characters



LaserPro

▲Select the desired font and size



LaserPro

▲**Bold** and *italic* style may also be used

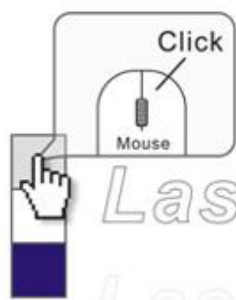

5

▲ On the palette, set the exterior frame as 10% gray level (Right click the mouse to set the color of the line for the exterior frame quickly)

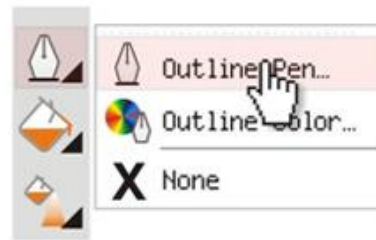

6

▲ Click on the Outline Pen tool



7

▲ Set the width of the line for the exterior frame



8

▲ Check the Behind Fill option



9

▲ Click OK to complete the text editing



10

▲ Three-dimensional characters are completed

**Step 3. Edit the characters for the website**



**Step 4. Combine the 3D images**

After finishing the production for each of the objects, you may proceed with the combination of the objects. The combined graphic may be output with the laser engraver.



**Output the 3D graphic**

After selecting the graphic to be output, set the Mode as 3D Mode in the driver. After setting the engraving parameters, output the 3D graphic.

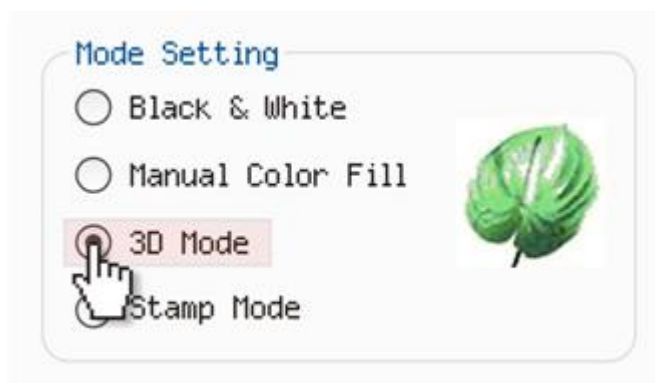

**Tips for engraving 3D graphics**

LaserPro Application Lab provides a few reminders that may require your attention during the 3D engraving in order to improve the result of the engraving.

### Turn on the Air Assist function

When the engraving is done along with Air Assist, the depth of the engraving would be deeper. Set Air assist inside the driver by checking the box.



### Polish

Dust will accumulate during the engraving when acrylic is engraved. The acrylic can be polished after the engraving. After the processing, don't remove the engraved object. Use the Control Panel to lower the platform (for about 7~8 mm) and then engrave once again to achieve the better finish.

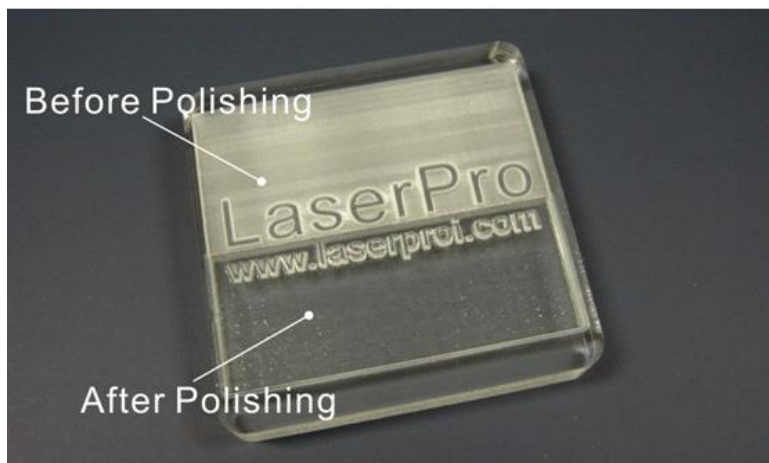

After engraving the wooden objects, please use a toothbrush with some clean water to remove the dust on top of the object.



## 6.5 Modify Image Settings of Picture for Better Engraving Quality

1. Connect your digital camera to the computer by USB cable.
2. Download the picture from the digital camera to the computer
3. Select the picture that you want to engrave.
4. Import the image from the folder where the picture is located by selecting File/Import

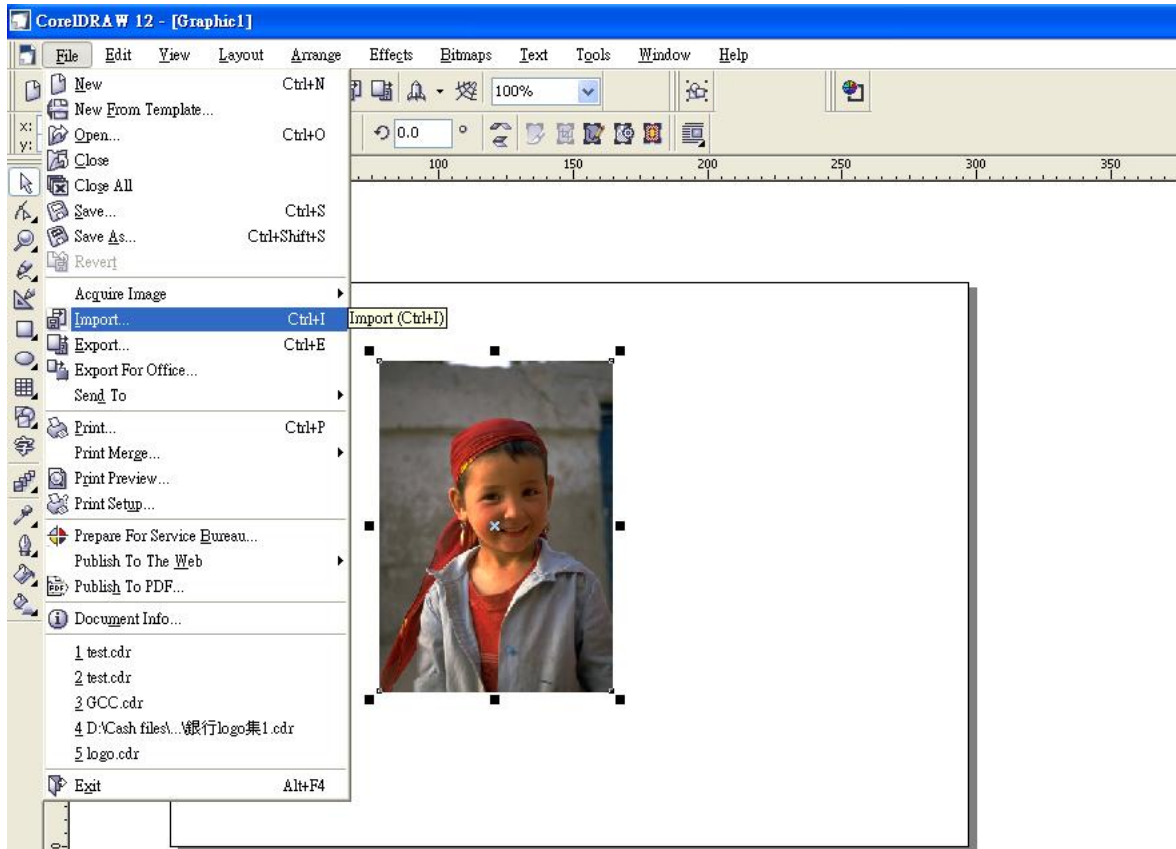

5. Convert the image to Bitmap by selecting the image and click on Bitmaps/Convert to Bitmap

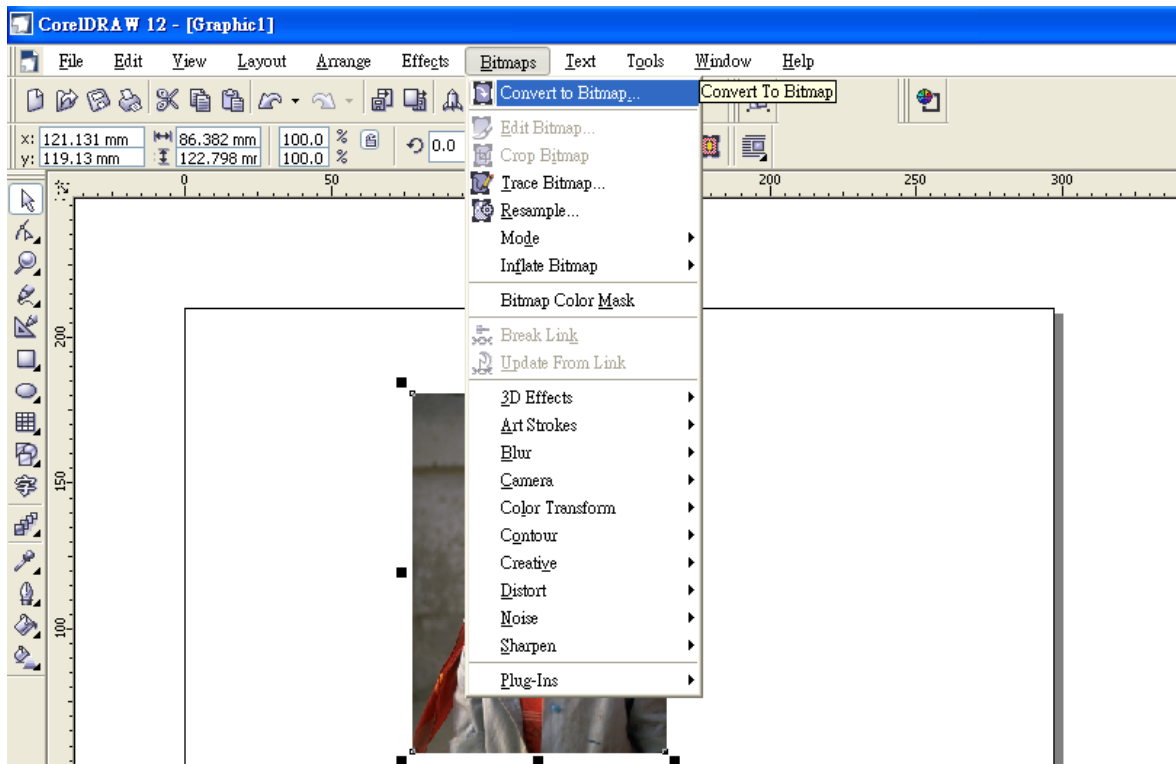

6. Change the Bitmap settings by setting “Color” to Grayscale (8-bit) and “Resolution” to 300 dpi and click OK.

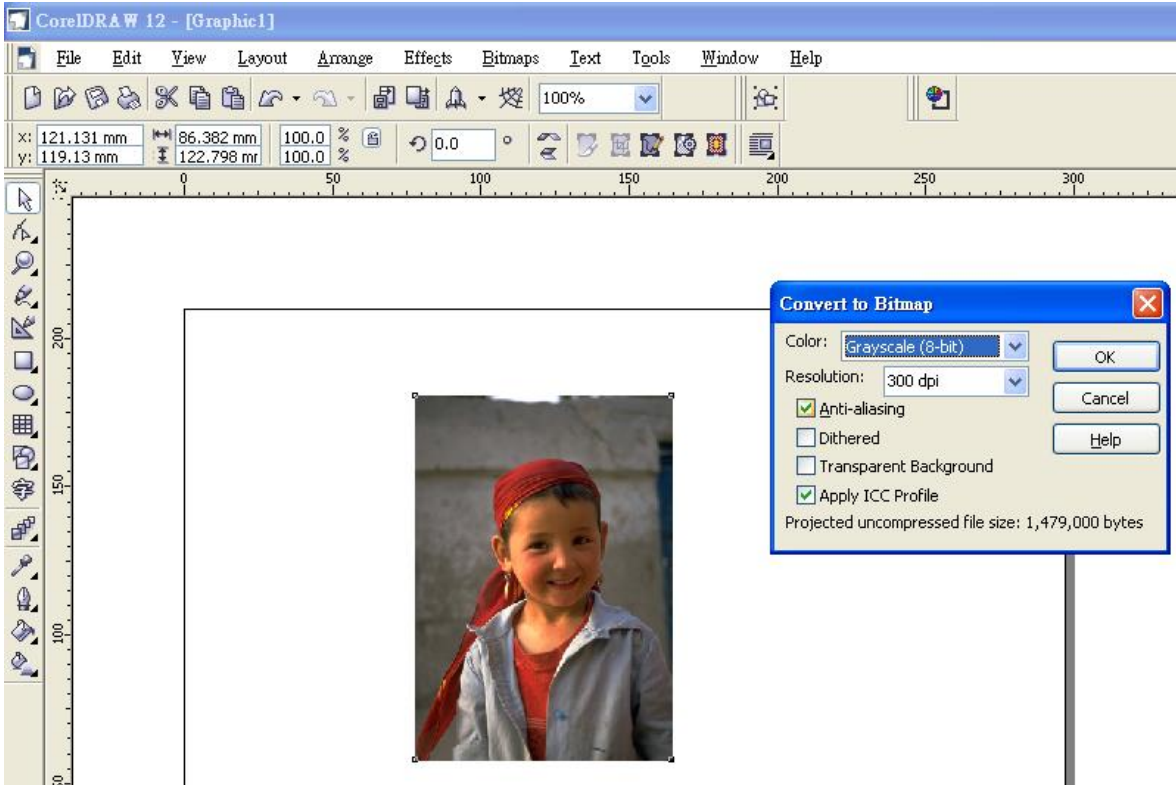

7. Finally, Invert the image by selecting Effects/Transform/Invert



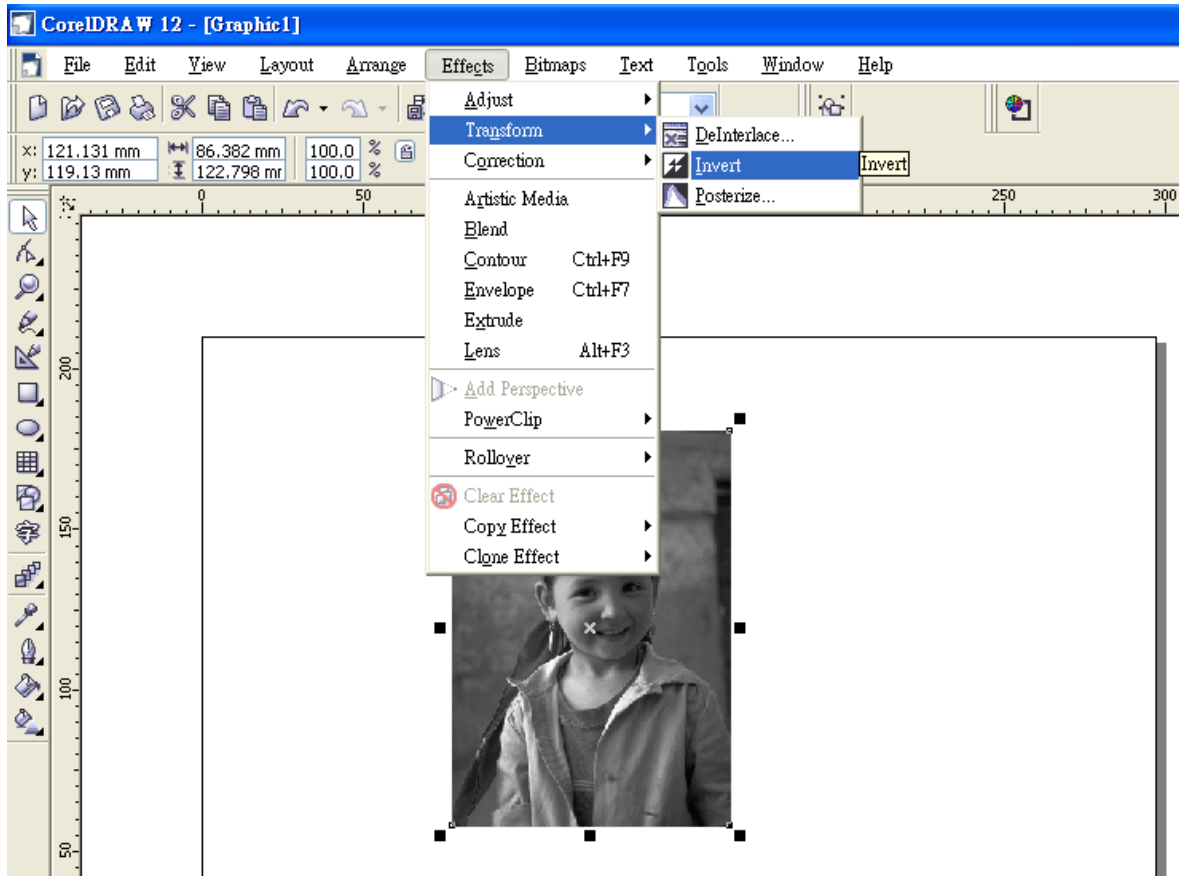

8. Now you are ready to output the modified image by clicking File/Print

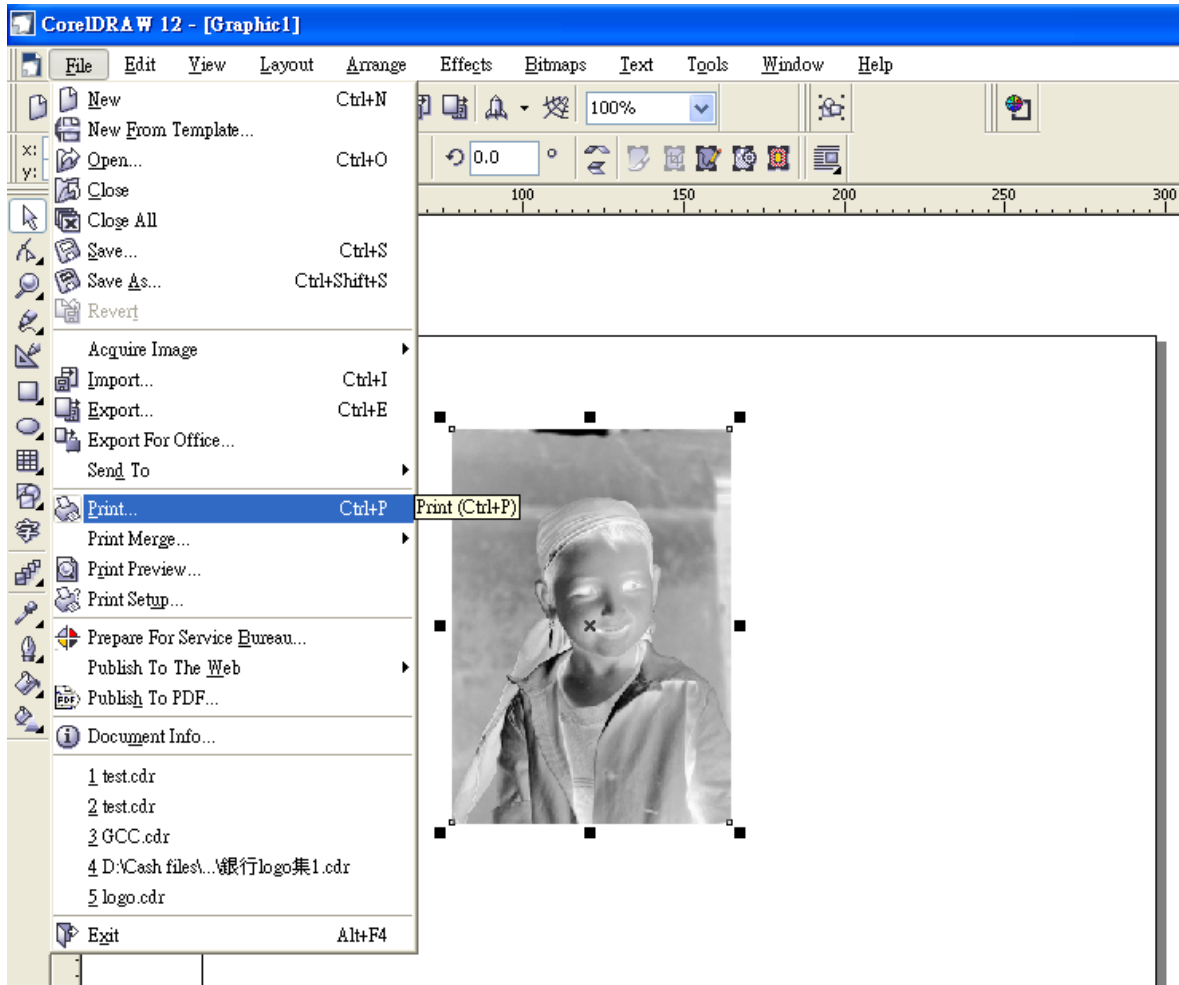

## NOTE

This instruction is a simple example for general use. There are many tips and tricks to achieve a good engraving quality. It takes a lot of practice and experience to achieve a good engraving quality. Different picture may need different modifications and different material may need different parameters.

# 7

## Chapter 7

---

# Optional Items

Fume Extraction Unit Option

Air Compressor Option Items

Focus Lens Option

Pass-Through Door Option

SmartBOX Option

Rotary Attachment Option

SmartGUARD Fire Alarm Option

Several optional items are available to enhance your experience with the Spirit Series system. If anytime after the purchase of your Spirit Series, should you ever consider to purchase any optional item, please contact your local authorized GCC distributor.

## 7.1 Fume Extraction Unit

To properly remove dust, vaporized materials and chemical smoke from the working area and machine, it is necessary to install a suitable air extraction system. The air extraction system and other components are readily available from your local authorized GCC distributor or you can elect to purchase and install one yourself with components found at your local industrial supply store.

LaserPro's Fume Extraction Units are specifically designed to prevent personnel from inhaling hazardous fumes and dust generated by the laser process. Available for all LaserPro engravers, the LaserPro Fume Extraction Unit represents the latest in exhaust extraction and odor reduction technology for all types of applications. Quiet operation, high vacuum capacity, compact design and long life expectancy are but a few outstanding features. Each LaserPro Fume Extraction Unit is powered by a maintenance-free, continuous-running turbine. In order to ensure personnel safety and legal compliance, the LaserPro Fume Extraction Unit is CE-compliant for Europe. To purchase a LaserPro Fume Extraction Unit, contact your local authorized GCC distributor.

### INSTALLATION (Self-Assembled Unit):

- 1) If you purchase an exhaust system at your local industrial supply store, we suggest that you have a contractor install the exhaust system. We highly recommend you to install the exhaust system outside of the building for both noise considerations and if it does not possess filtering capabilities.
- 2) Mount the fume ventilation system in an obvious and accessible location, not too far from the GCC LaserPro machines, so it can be routinely switched on prior to laser engraving. The maximal distance you should mount the exhaust system away from the Spirit Series depends on the blower's vacuum capacity. We recommend that you consult with the vendor regarding the unit's vacuum force, maximal distances, based on the available models.
- 3) Connect rigid and smooth walled tubing such as PVC or sheet metal with a 4" diameter to the ventilation opening located on the rear side of GCC LaserPro machines. (As shown in the picture below). Try to keep this tubing as straight as possible as bends reduce the exhaust efficiency. Use the appropriate sized tube clamps and sealants to ensure a tight and secure attachment.
- 4) There are two exhaust openings on the rear side of GCC LaserPro machines, you can connect the top or bottom one, or both for application requirements. The top ductwork is suitable for dust, smoke generated on material surface when doing laser engraving, which will reduce residue left on material surface; while the bottom ductwork is recommended for laser cutting jobs. Optimum down vacuum is critical for clear cutting edge when laser cutting materials.

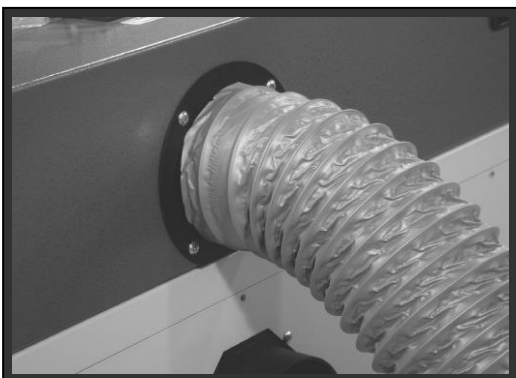

## 7.2 Air Compressor

Specifically designed for laser engravers, the air compressor utilizes an oil-free diaphragm. The air compressor helps to eliminate harmful and potentially damaging moisture from the laser optics, maximizing life of the laser optics. In addition, the air compressor provides an optimal air flow to the SmartAIR nozzles to minimize flaming, suppress working temperatures, and blow away dust and particle by products generated from the laser process. GCC LaserPro Spirit series provides an air control by pen color function in Windows driver to enable or disable air assist automatically per different pen jobs. Refer to Chapter 5.2.4.2 about driver operation in pen page.

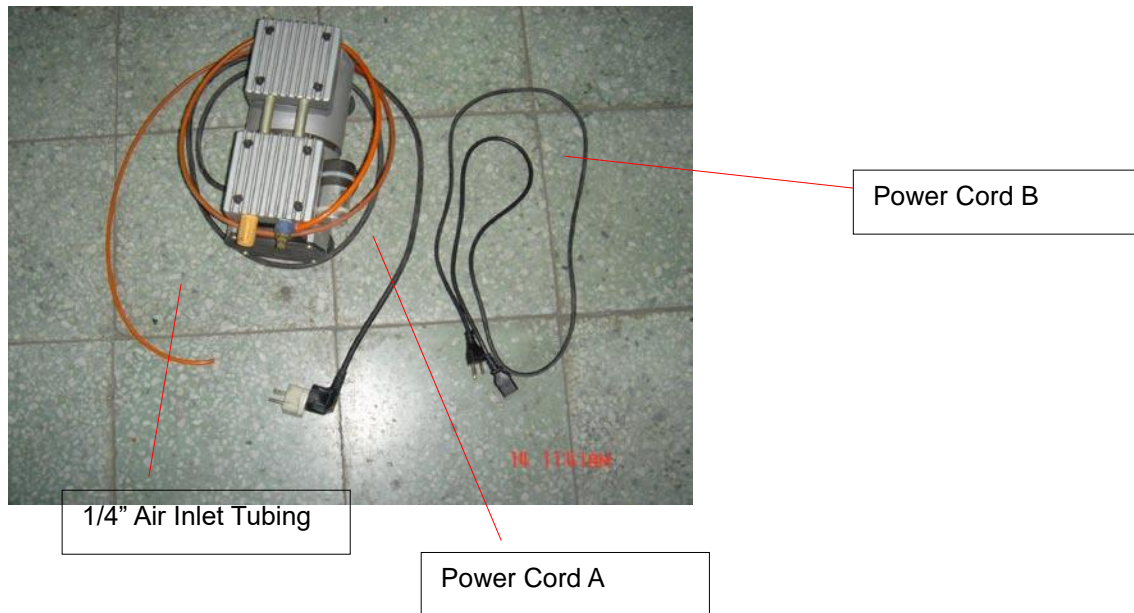

### **INSTALLATION:**

- 1) Remove the plugs on the air compressor to expose the air inlets.
- 2) Fasten the included air tube fastener valve to the outgoing air inlet (indicated by 2a) and the air filter into the ingoing air inlet (indicated by 2b).

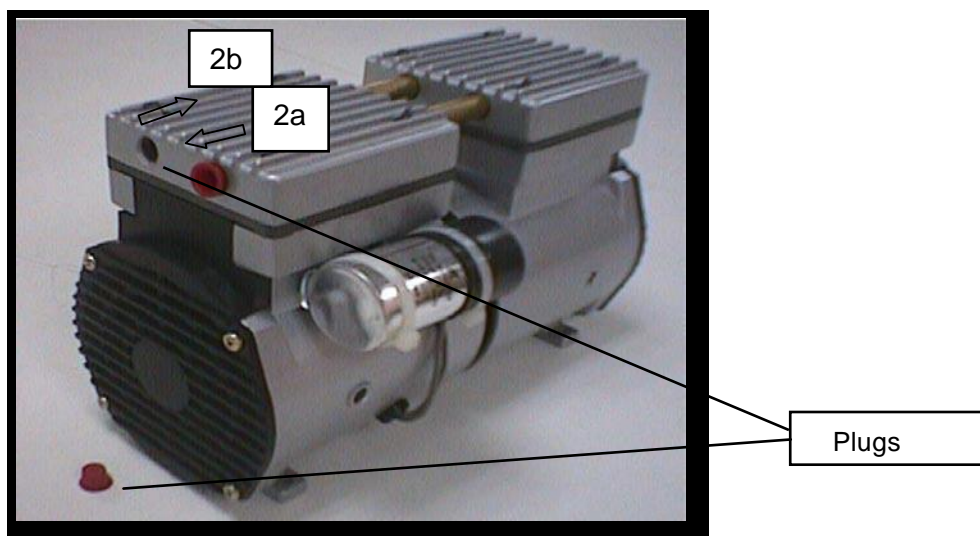

- 3) Connect a 1/4" tubing to the air tube fastener valve on the air compressor.

### **NOTE**

It is important that the 1/4" air tubing has clean, straight cuts on each end. Jagged or slanted cuts will not produce adequate sealing capabilities.

- 4) Open the bottom front doors of the Spirit series laser engraver to locate both the Air-Assist Valve and Internal Power Sockets. As indicated below:

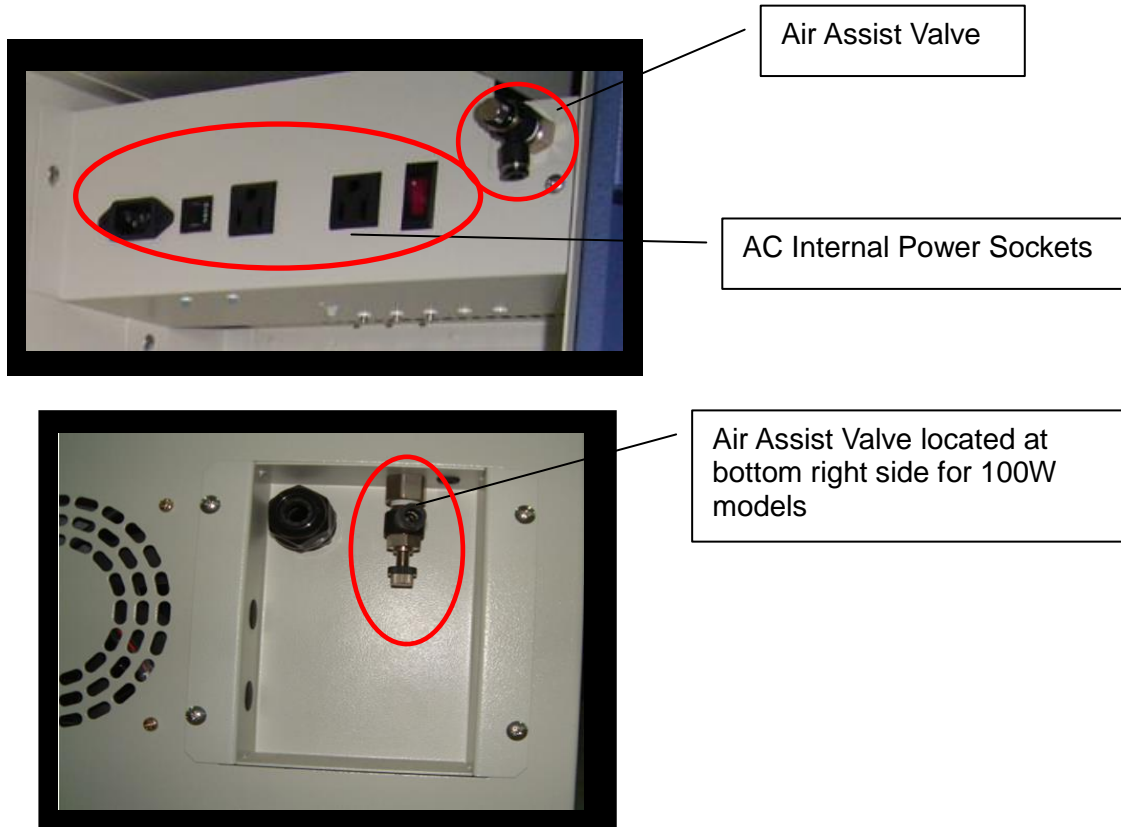

- 5) Plug the air compressor's power cord A into the AC internal power socket.
- 6) Plug the female end of power cord B to the AC internal power socket and the male end to an external power outlet.

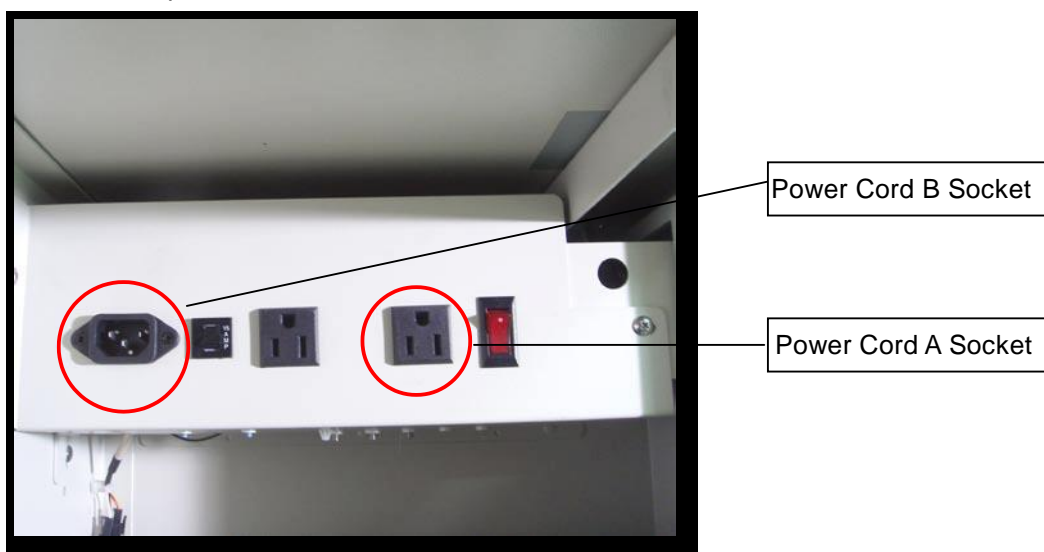

- 7) Take the unattached end of the 1/4" air tubing (other end already connected to air compressor) and connect it to the air tube connector on the air assist valve. Make sure you press down on the air tube fastener when inserting the 1/4" air tubing, to form a tight, secure attachment as indicated in the diagram below.

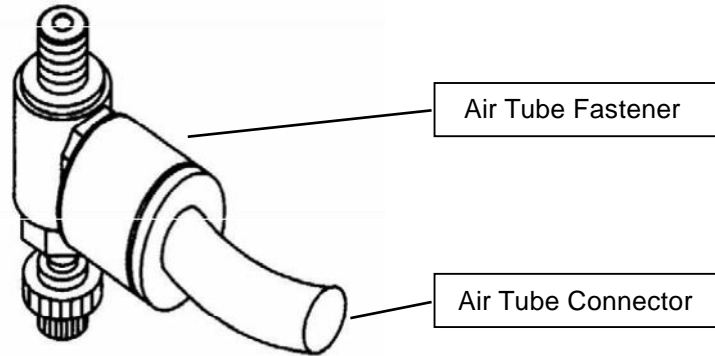
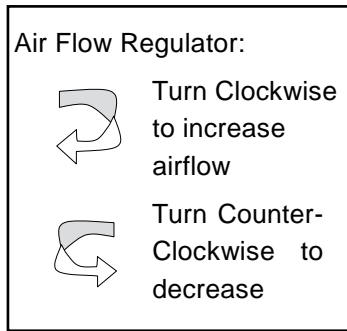

- 8) Congratulations, you have finished setting up the air compressor. Make sure you have the proper SmartAIR nozzle installed (depending on your application), before you turn on and utilize the air compressor.

**OPERATION:**

Switch on the air compressor unit and make sure that the airflow regulator on the air assist value is opened (turn clockwise to increase the airflow, counter-clockwise to decrease the airflow). The air nozzle under the laser head should emit a steady flow of air.

With the SmartAIR nozzle and air compressor properly installed and operating, all configurations and settings relating to air-assist functions are controlled through the LaserPro Spirit GLS print driver and hardware control panel. Please refer to the LaserPro Spirit GLS PEN page on print driver section of this manual for details on how to enable and configure air-assist functionality.



## 7.3 Focus Lens Options

### 7.3.1 CO2 Laser Focus Lens

GCC offers four different focal lenses namely the 1.5", 2.0", 2.5", and 4.0" for different applications. The number description, 1.5", 2.0", 2.5", and 4.0" signifies the distance of where passed through beam will converge. For example, when a laser beam passes through a 2.0" focus lens, the beam will converge at a 2.0" distance resulting in a concentration of energy at that spot.

The resulting spot size from the different focus lens are also different and the following chart shows the different spot sizes achieved from the different lenses.

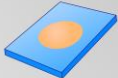
- 1.5" Lens: The 1.5" lens is best when used for engraving of very fine details
- 2.0" & 2.5" Lens: The 2.0" & 2.5" lenses are good for normal engraving and cutting of up to 10mm thick acrylic.
- 4.0" Lens: The 4.0" lens is good for 10mm and above acrylic cutting.

 Lens	1.5"	2.0"	2.5"	4.0"
 Spot Size	0.0029" (0.073mm)	0.0039" (0.099mm)	0.0048" (0.121mm)	0.0078" (0.198mm)

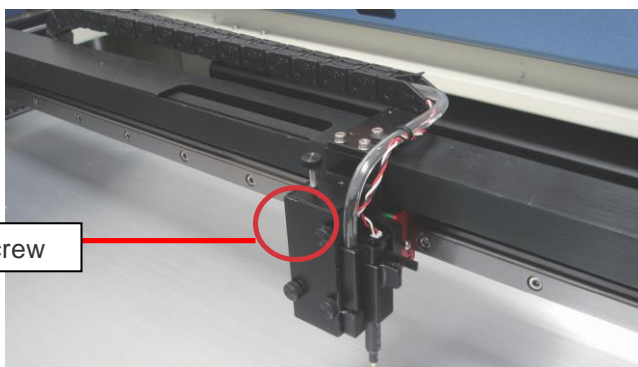

Unscrew the three thumb screws on lens carriage to remove the carriage panel. Take out the lens carriage and insert the optional one for different applications.



Engraving effects achieved with the different lenses



Cutting edges achieved with the different lenses

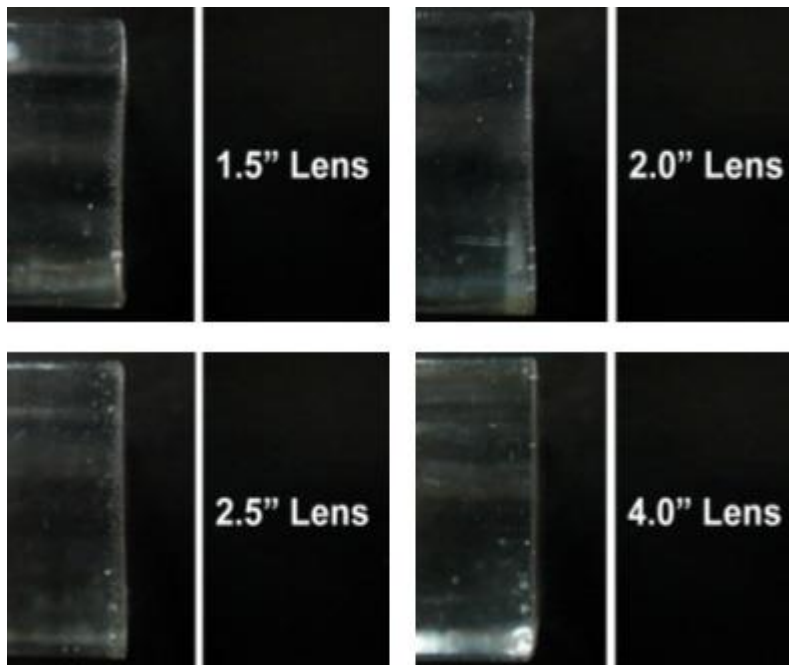



### 7.3.2 Hybrid (Dual Lasers) Focus Lens

GCC offers 2.0" focal lenses for Spirit GLS Hybrid models with dual laser tubes installed. The number description, 2.0" signifies the distance of where passed through beam will converge. For example, when a laser beam passes through a 2.0" focus lens, the beam will converge at a 2.0" distance resulting in a concentration of energy at that spot.

The following chart shows the application and spot size achieved from the focus lens.

- 2.0" Lens: The 2.0" dual laser focus lens is good for normal engraving and cutting of organic and metallic materials.

 Lens	2.0"	2.0"
 Spot Size	0.0039" (0.099mm)	0.0011" (0.0297mm)
Laser Type	CO2 Laser	Fiber Laser

## 7.4 Pass-Through Door Options



GCC Spirit Series laser systems are designed to be Class II safety requirement, the laser would stop firing if any door open during operation to protect operator safety. For users installed optional Pass-Through Door switch module, GCC laser system will be converted to Class IV safety machine, operators must follow the safety notice stated in Chapter 1.5 of this manual.

### How to Install Pass-Through Door Switch Option

Step 1. Open the top window of laser machine then lower down the work table of laser system to the bottom.

Step 2. Locate the Pass-Through Door switch key connector at the top-right corner of machine chassis

Step 3. Plug the Pass-Through Door switch key to the female connector

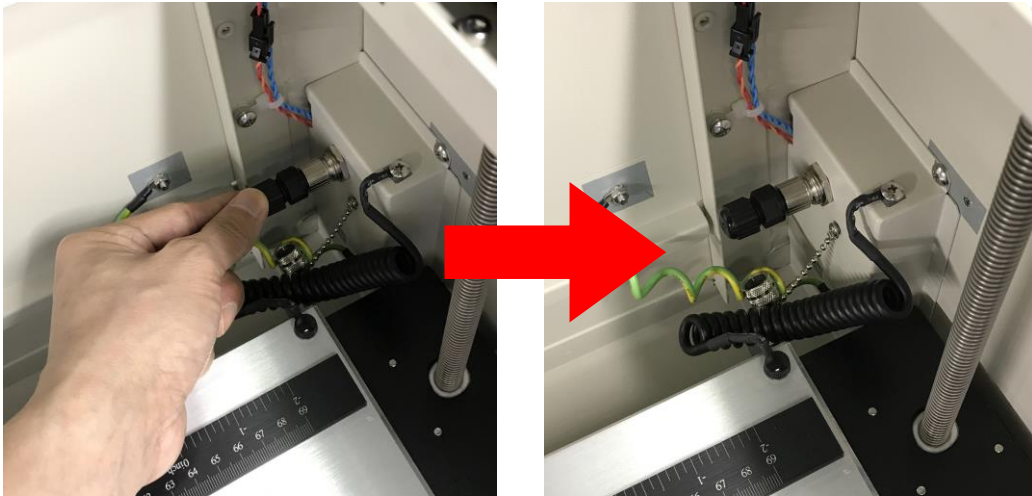

Step 4. Locate the external signal connector on the rear-right of laser system, and plug the warning light to this port. Put the warning light on top of laser machine with high visibility as class IV safety requirement.

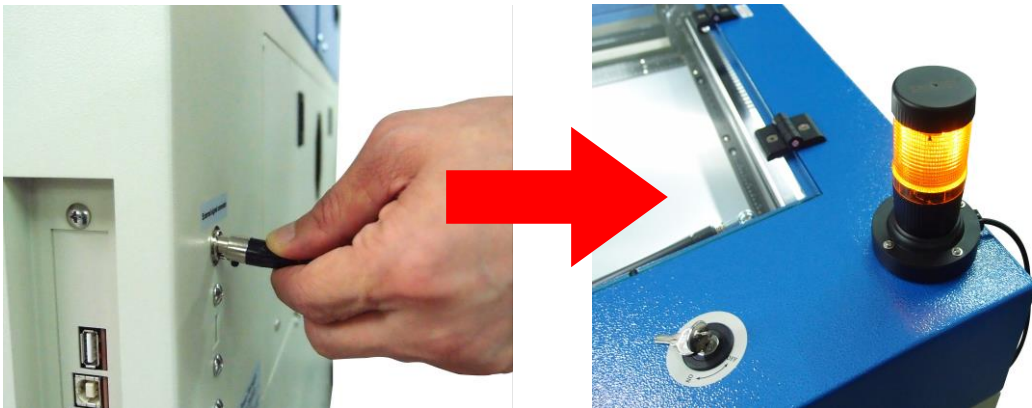

## 7.5 SmartBOX Cutting Accessory

The SmartBOX is an innovative combination of a cutting box, honeycomb table, and material support stands. During the cutting and engraving process, unwanted scrap, dust, and vapor byproducts are left behind. The cutting box collects the larger scrap byproducts while venting out the smaller dust particles, vapors, and smoke to minimize excess buildup on the machine, worktable, and your project. The SmartBOX allows you to maintain a clean worktable and minimizes backside burning of your media, whether you are working with thick and firm materials or thin and flexible materials.

### SmartBOX Components

- Cutting Box (a)
- Honeycomb Table (b)
- Material Support Stands (c)
- Thumb Screws (d)
- Aluminum Grid Table (e)

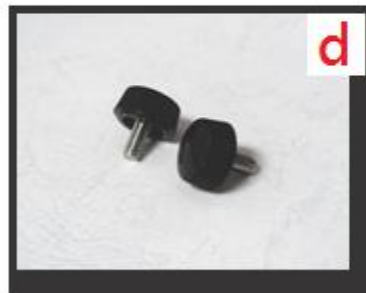
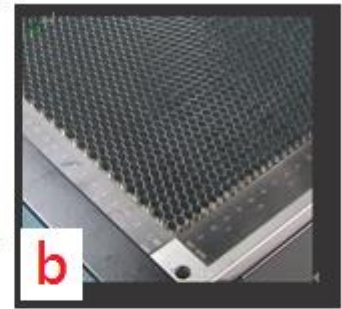

It is highly recommended that you use different setups of the SmartBOX depending on the physical properties of the material you will be working with. Here is the recommended SmartBOX component setups based on your working material.

Component \ Application	Cutting Box	Honeycomb Table/ Aluminum Grid Cutting Table	Support Stands
Thin, Flexible Materials	Required	Required	Not Required
Thick, Firm Materials	Required	Not Required	Required

Action	Suggestion setups
Engraving	NO Smart Box
Light cutting	honeycomb table
Thick cutting	Cutting box + Support
Thin textile/fabric module	smart box

## NOTE

Experienced users may choose to try other component setups to suit their particular engraving / cutting techniques or working material. Feel free to explore different ways to setup the various SmartBOX components to generate results you wish to achieve.

### **INSTALLATION/ OPERATION (Cutting Box and Honeycomb Table/ Aluminum Grid Cutting Table):**

- 1) Open the front pass-through door and lower the work table to the lowest possible position through the control panel.
- 2) Insert the cutting box and attached honeycomb table through the open front pass-through door onto the work table, with the air extraction opening facing towards the back end of the Spirit Series. Ensure the rear and left side of the cutting box is aligned to the edges of the left and right rulers on the work table.
- 3) Lift the honeycomb table to find the four screw holes at the bottom of the cutting box. With the included thumbscrews, secure the cutting box to the work table and close the honeycomb table.
- 4) [OPTIONAL] If you have an air extraction system option installed, then you will need to attach the air extraction system's pipe connector to the SmartBOX's air extraction opening from the Spirit Series rear side. (For detailed instructions to setup the air extraction system, please see the AIR EXTRACTION UNIT section in section 7.1).

Congratulations, you are now ready to position your thin, flexible materials on top of your honeycomb table / cutting box and commence your tasks.

### **INSTALLATION/ OPERATION (Cutting Box and Material Support Stands):**

- 1) In order to use the cutting box along with the material support stands, you must first remove the honeycomb table from the cutting box. Before you position the cutting box in the Spirit Series, first loosen the screws that attach the hinges of the honeycomb table to the cutting box.
- 2) Remove the honeycomb table. Please keep in mind the honeycomb table surface is fragile; therefore, it is suggested to keep it in a safe place.
- 3) Open the front pass-through door and lower the Spirit's work table to the lowest possible position through the Spirit Series control panel.
- 4) Insert the cutting box through the open front pass-through door and place it onto the work table, with the air extraction opening facing towards the back end of the Spirit Series. Ensure the rear and lefthand side of the cutting box is aligned to the edges of the left and right rulers on the work table.
- 5) Find the four screw holes at the bottom of the cutting box. With the included thumbscrews, secure the cutting box to the work table.
- 6) On the front right hand side of the cutting table, there will be a metal guard, which must be swiveled so that it is perpendicular to the front side of the cutting table (as shown in the picture below). This allows the Spirit Series to properly account for the extra height the cutting table which adds to the cutting table.

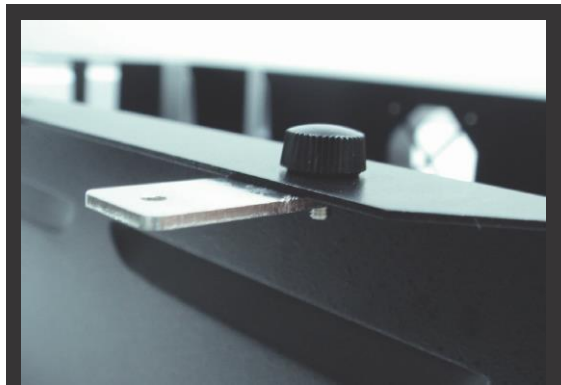



## CAUTION

Damage may occur to the system if you try to raise the work table without proper setting of the metal guard.

- 7) Now position the included material support stands so they support the thick, firm material you will be working with, while avoiding the laser path. In other words, avoid placing the support stands underneath any section of the material that will be lasered, especially during laser cutting.

## 7.6 Rotary Attachment & Rotary Chuck

The rotary attachment and rotary chuck options provide the Spirit Series with the ability to engrave on cylindrical or spherical objects. In addition to the standard X, Y, Z axis, the rotary attachment and rotary chuck allow for a fourth axis which rotates your object 360° to allow for engraving on cups, wine glasses, and even balls. Users can choose rotary attachment or rotary chuck according to their applications.

### Rotary Attachment Specification

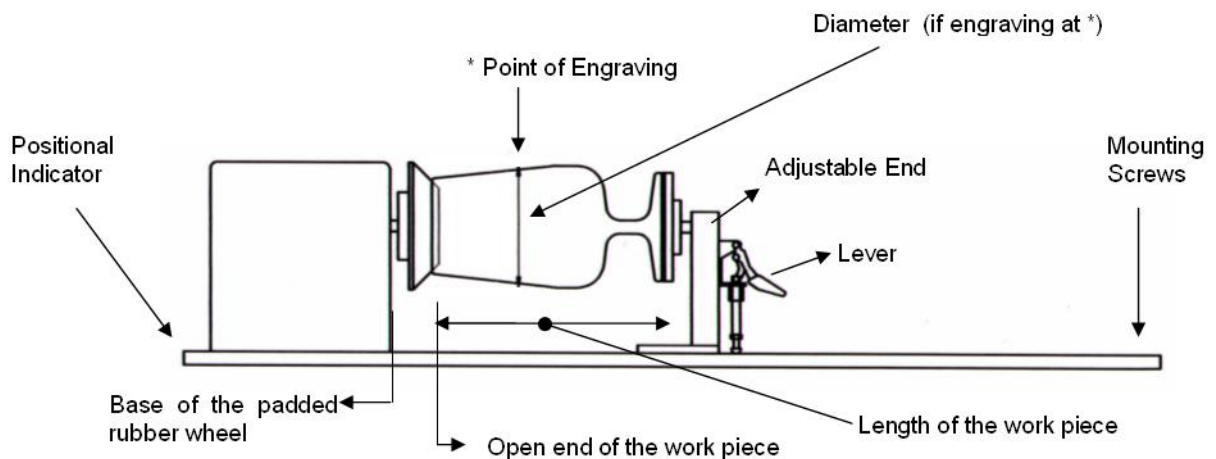

#### Medium Rotary Attachment for Spirit, Spirit LS models:

Work Piece Limitations	
Maximum Length	450 mm (17.71 inches)
Maximum Loading Weight	4 kg (8.8 lbs.)
Minimum Inner Diameter (Large conical fixture)	50 mm (1.96 inches)
Maximum Inner Diameter (Large conical fixture)	76 mm (2.99 inches)
Minimum Inner Diameter (Small conical fixture)	12 mm (0.47 inches)
Maximum Inner Diameter (Small conical fixture)	46 mm (1.8 inches)
Maximum Outer Diameter	176 mm (6.9 inches)

**Large Rotary Attachment for Spirit GLS and Spirit GLS Hybrid model:**

<b>Work Piece Limitations</b>	
Maximum Length	650 mm (25.59 inches)
Maximum Loading Weight	4 kg (8.8 lbs.)
Minimum Inner Diameter (Large conical fixture)	50 mm (1.96 inches)
Maximum Inner Diameter (Large conical fixture)	76 mm (2.99 inches)
Minimum Inner Diameter (Small conical fixture)	12 mm (0.47 inches)
Maximum Inner Diameter (Small conical fixture)	46 mm (1.8 inches)
Maximum Outer Diameter	176 mm (6.9 inches)

**Exchange the Conical Fixtures:**

A. Remove the 2 screws shown in the picture below.

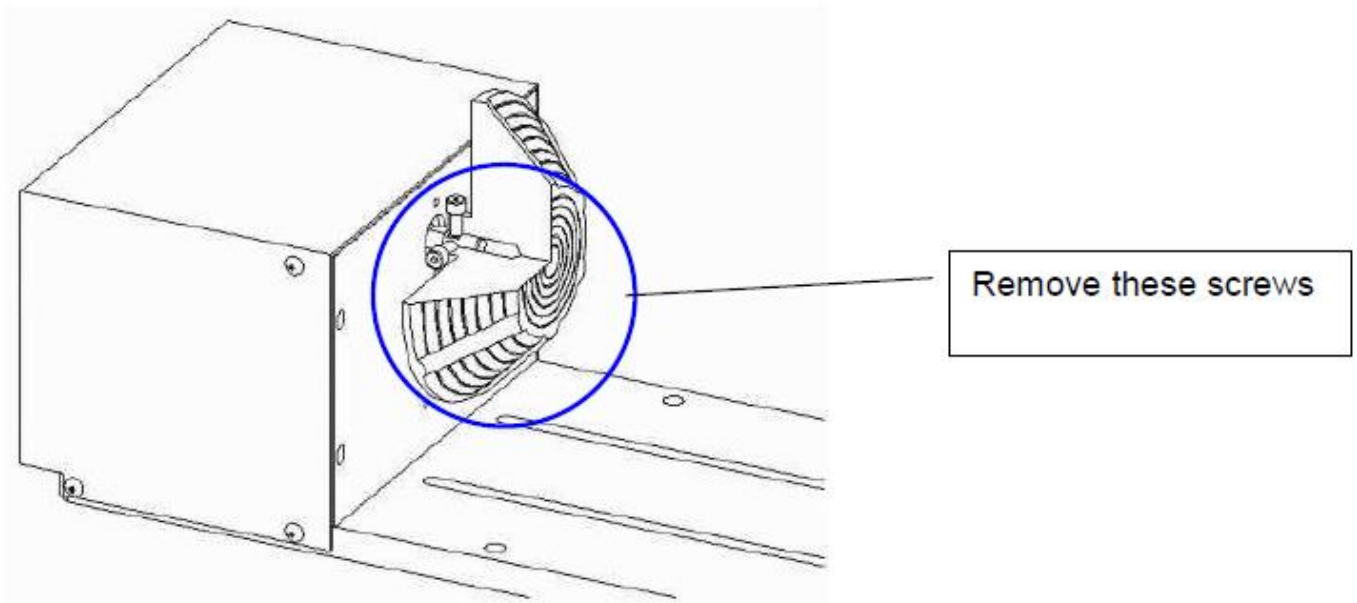

B. Detach the circular cylindrical cone by moving it in the direction of the arrow as shown below.

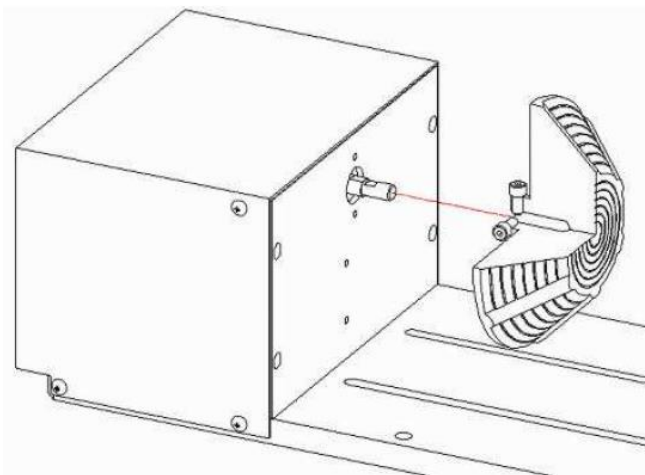

C. Assemble the smaller conical fixture onto the rotary attachment as shown below.

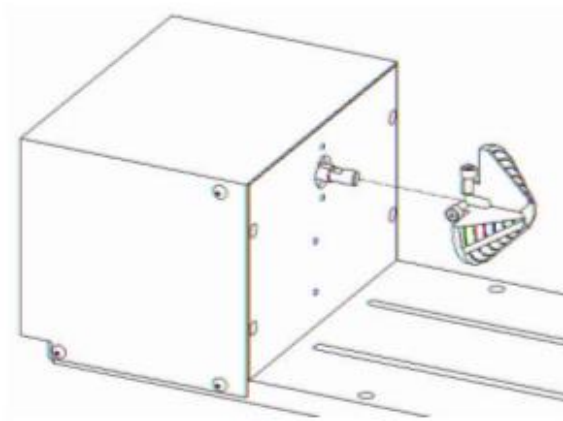

D. Use the flat surface as shown in picture below as a reference point and tighten the first screw against it. After doing so, tighten the second screw and the rotary attachment is ready for use.

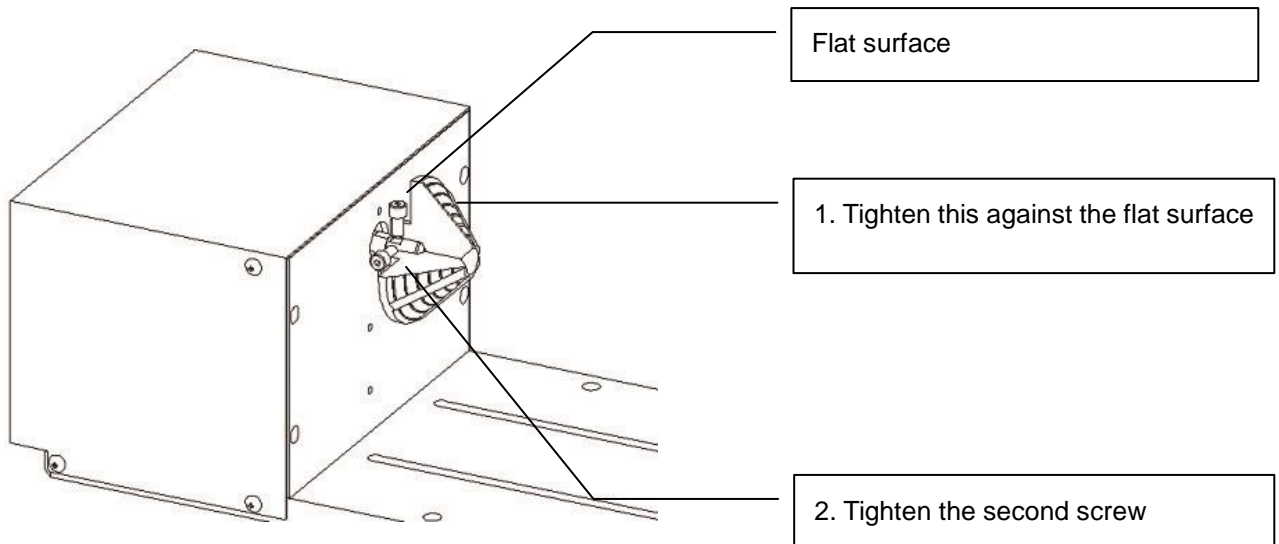



## **Rotary Chuck Specification:**

GCC LaserPro offers different design options to work with cylindrical objects. The Rotary Chuck can hold smaller diameter of working object tightly, tilt with different angles for laser processing.

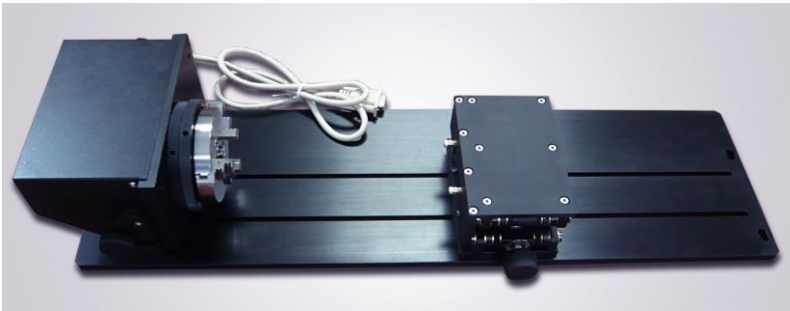

Work Piece Limitations	
Maximum Length	410 mm (16.14 inches)
Maximum Loading Weight	4 kg (8.8 lbs.)
Minimum Diameter	0.5 mm (0.02 inches)
Maximum Diameter	120 mm (4.7 inches)

## **INSTALLATION for Rotary Attachment and Rotary Chuck:**

- 1) Turn off the power of the engraver before installing the Rotary option (Rotary attachment and Rotary chuck.)
- 2) Set the rotary option onto the engraving table so that the bottom mounting screws correspond to the positional holes on the engraving table. In addition, the top end of the rotary option must be leveled against the engraving table with the rotary's positional indicator (center point of the top of the rotary) aligned to the center position on the engraver's Y (vertical) axis.
- 3) With the rotary properly positioned, tighten the mounting screws to secure the rotary.
- 4) Open the front panel of the Spirit and connect the rotary cable to the rotary port located inside the Spirit's front panel (shown in the picture below)

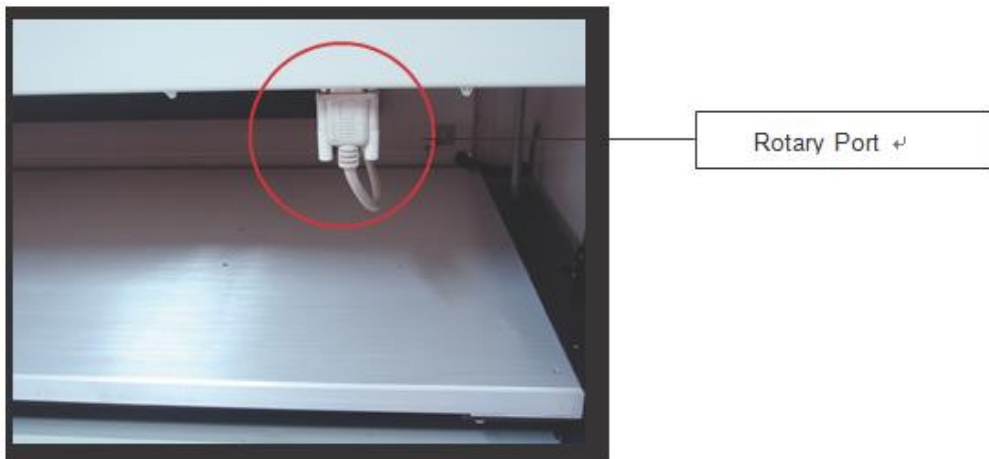

- 5) Close the front panel.

- 6) The rotary is now properly installed. Power on the laser system and the rotary option will be automatically detected and the engraving table will automatically move to its lowest position. The selection screen will be shown on control panel automatically.
- 7) Despite the dummy-proof installation design, please ensure that the device is installed correctly before turning on the machine.
- 8) Please select your device type "Attachment" or "Chuck" then press F4 on control panel to save.

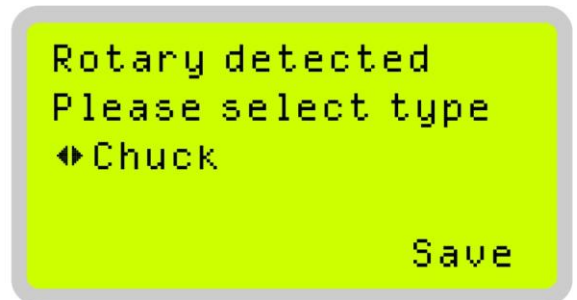
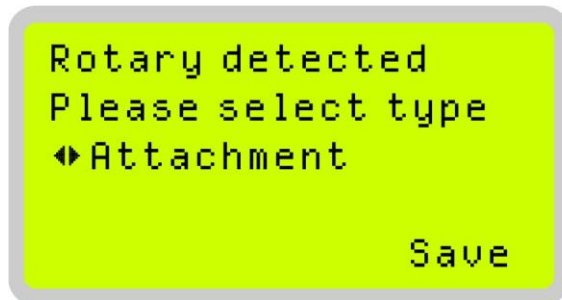

### **OPERATION of Rotary Attachment and Rotary Chuck:**

- 1) Use a ruler to measure the diameter (at the point on the work piece you will be engraving) and length of the work piece you will be engraving. Make a record of this.
- 2) Load the work piece onto the rotary attachment
  - a) First list the lever on the rotary attachment, unlock the adjustable end of the rotary attachment. Slide the adjustable end to accommodate the length of the work piece. Load the working piece by centering the open end of the work piece against the rubber wheel and slide the adjustable end to fit the bottom of work piece firmly. Now simply lower the lever to secure the work piece with the rotary attachment.
- 3) Load the work piece onto the rotary chuck
  - a) Unlock the adjustable rear end of the Rotary Chuck, load the work piece onto the Rotary Chuck by centering the object to the clamping end and adjustable rear end. Adjust the leveling screws on the rear end of Rotary Chuck to make sure the work object is centering to the clamping end, thus work piece is horizontally leveling to the laser carriage in X axis. Slide the adjustable rear end to accommodate the length of the work piece firmly.

b) To load the object, you can use the enclosed tools to widen or tighten the metallic claws. Simply insert the two metal pins into the holes on the turn-dial and turn it to widen or tighten the claws to hold the engraving object.

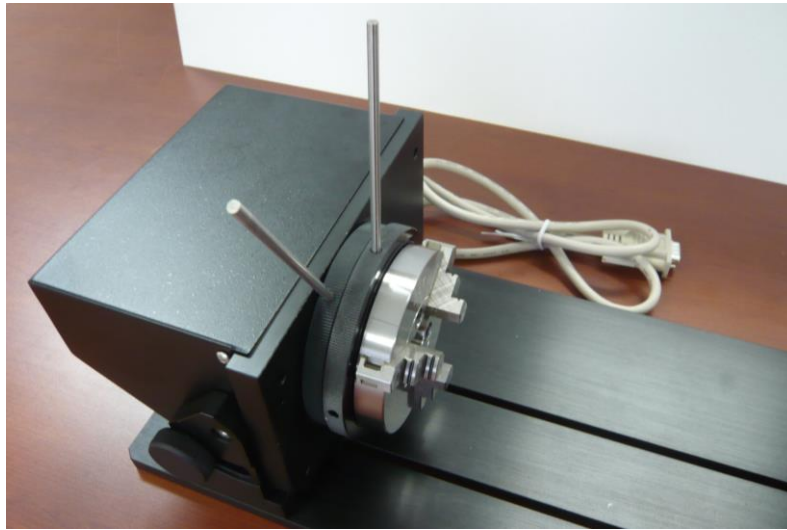

There are two different ways that the rotary attachment can hold an object, by sliding the clamps inwards or outwards to hold the object as shown below.

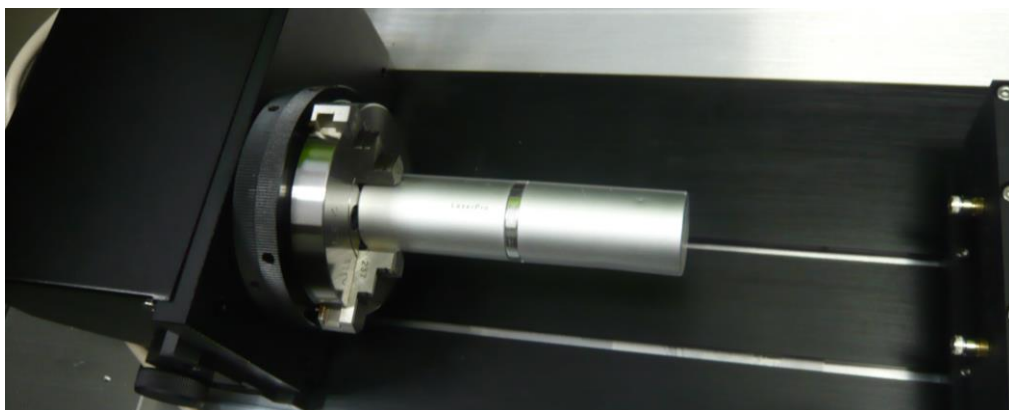

The clamps on the rotary attachment can be detached and reverted for better fitting of objects of different sizes. Note that the clamps should be assembled by lining up the correct numbers.

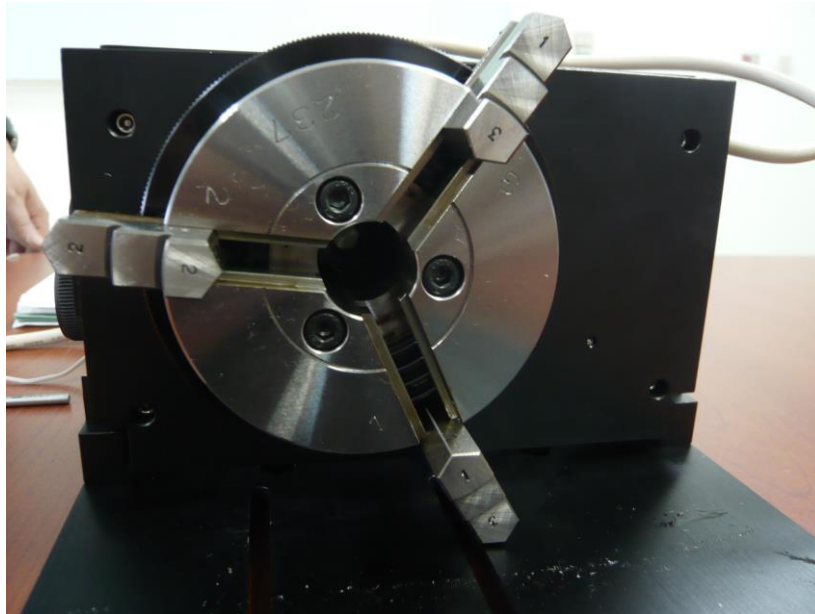

Please remember to lubricate the detachable clamps along the groove with machine oil regularly after each use.

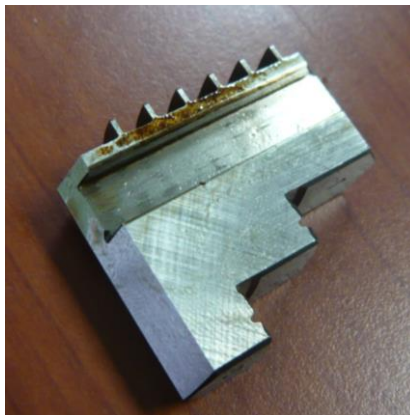

The rear end of the Rotary Chuck also can be locked or unlocked to slide its position by using an Allen key as shown below.

Dial the lever indicated with red arrow below to move up or down the rear end which will adjust its leveling to match clamping end. The red circle marked leveling screws can be removed and reassembled to different height level of openings with Allen key.



## CAUTION

If your work piece is small, please apply 4" focal lens for operation to prevent the lens carriage from colliding with the rotary attachment.

4) Manually move the laser carriage to the proper X/ Y location on the work object where you will do laser engraving or cutting. Hit the Auto Focus button on control panel and the laser machine will now properly focus at the location to be laser engraved or cut.

5) Prepare the graphic you would like to work with the Rotary Chuck, print it to GCC laser Print Driver, and go to "Paper" page of the Print Driver.

Options Pen Advanced Paper Language Raster

Paper Size

X: 712.00 mm

Y: 370.00 mm

Unit

Metric (mm)

Imperial (inch)

Rotary Parameter

Offset: 0.00 mm

Image Tuning

0

Rotary Fixture

- 6) From the Paper Page, the first thing you must do is to check the Rotary Fixture. The Paper
  
- 7) Size options and Rotary Parameter will change to allow for proper input based on your rotary attachment.
  - a) Under Paper Size, the X value represents the length of your working piece. Enter the length of your work piece in this field.
  - b) Under Paper Size, the Diameter value represents the diameter of your working piece (at the position you wish to engrave). Enter the diameter of your work piece in this field. Again remember the proper diameter value would be the diameter location on your work piece you will be engraving.
  - c) Under Rotary Parameter, the Offset value represents distance from machine default origin to where you would like to start laser job. The default value is zero.
  
- 8) Go back to other pages of GCC Laser Print Driver to set up laser parameters like speed, power, dpi etc. (refer to Chapter V of user manual of laser machine for details) and click "OK" to print your design to laser machine for starting job
  
- 9) Despite the dummy-proof installation design, please ensure that the rotary device is installed correctly before turning on the machine

## 7.7 SmartGUARD Fire Alarm Option

Laser cutting and engraving operations using the SmartGUARD device protects the operator, machine, produced and the work products from potential fire hazards. During the engraving process, flames may be produced when working with combustible or easily-flammable materials, such as paper or wood. The SmartGUARD is an optional item that can be set to notify the operator through audio warnings and automatically shut down the laser firing as a safety precaution.

**Note that SmartGUARD fire alarm is an fire detecting and alarm system, not a fire extinguisher.**

### INSTALLATION:

If you have purchased your system with SmartGUARD, then no installation is required, as your system will arrive with SmartGUARD pre-installed.

For system owners that did not initially purchase this option, but would now like to add the SmartGUARD, they will need to contact your local authorized GCC distributor to have this great feature installed.

1. Lift the SmartLID using the handles.

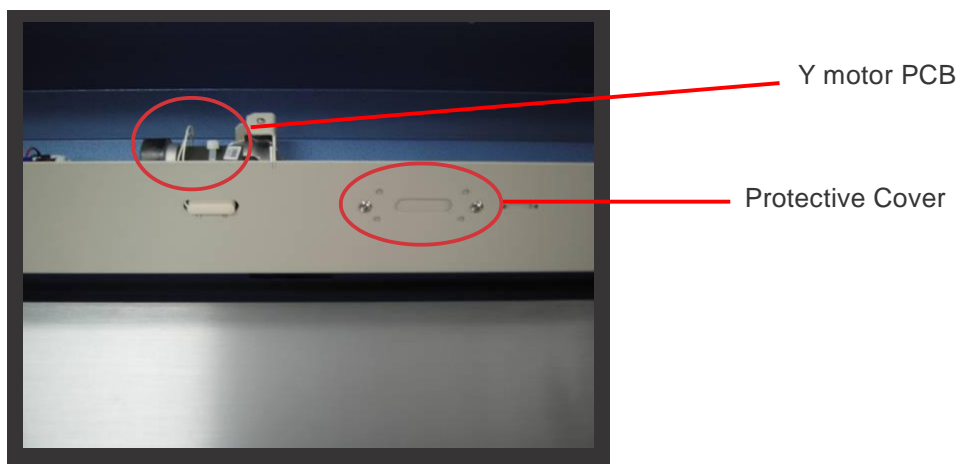
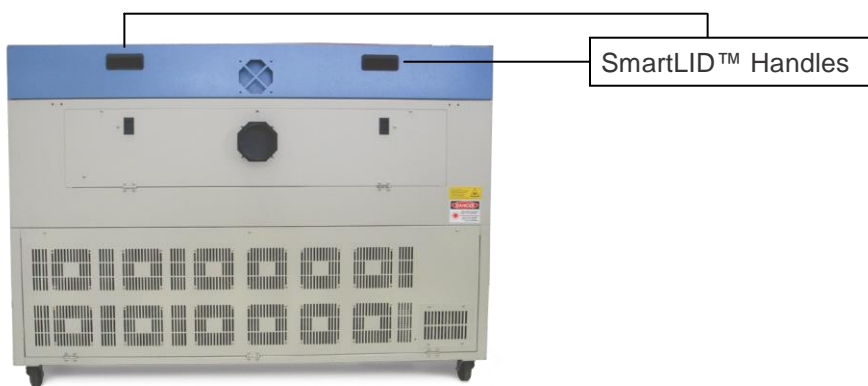

2. Remove the protective cover



3. Fix the SmartGUARD on the reserved place.



Front View

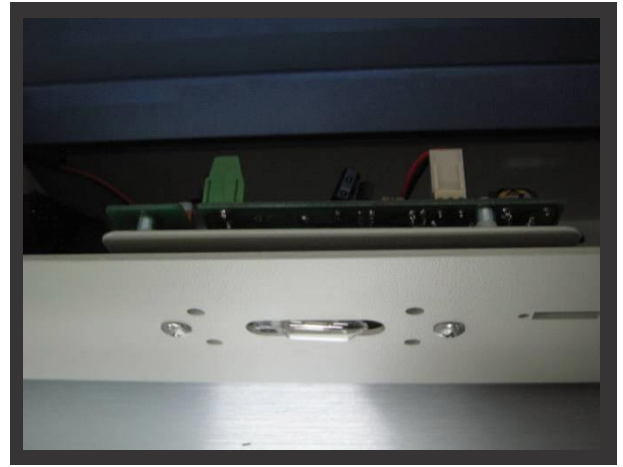

Top View

4. Connect the wire from the SmartGUARD sensor board to the Y motor PCB.

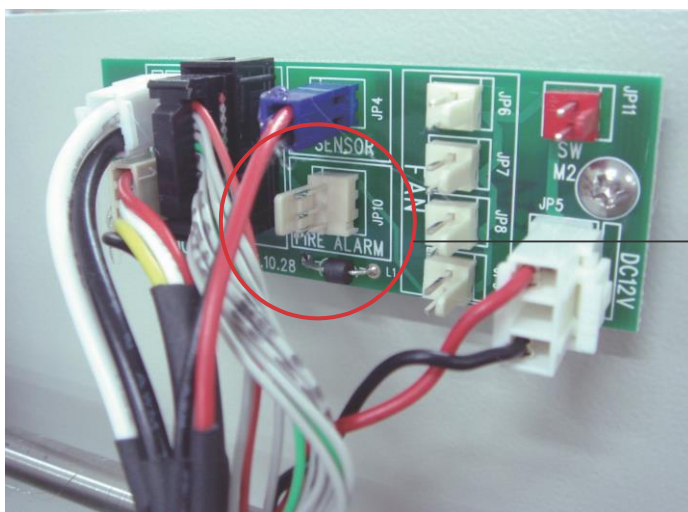

The SmartGUARD 3-pin signal jumper is positioned under the blue connector of the Y motor PCB

5. Gently cover the SmartLID.



## OPERATION MENU:

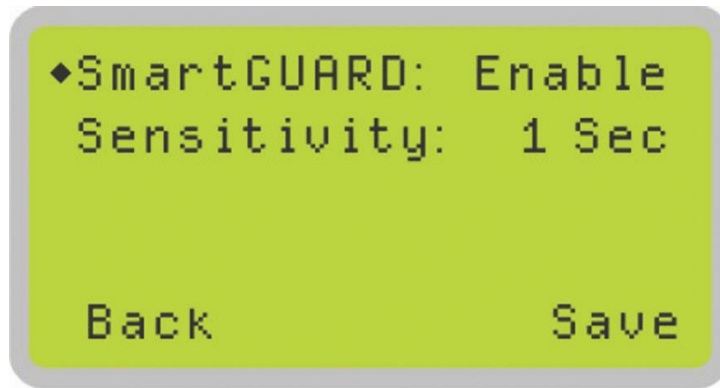

**i** Navigating to this page:

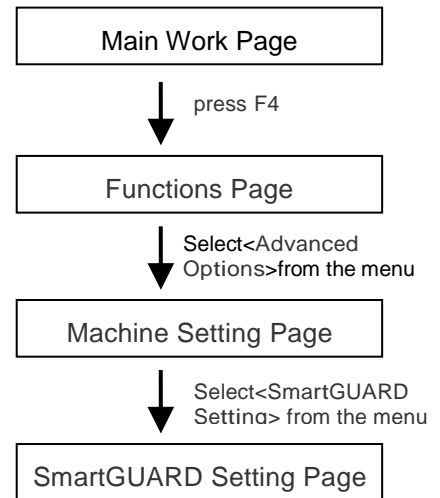

After hardware installation, please enter the function menu on the control panel to enable the SmartGUARD fire alarm.

### SmartGUARD Enable / Disable:

Press directional key (left or right) to enable the SmartGUARD device or disable it.

### Sensitivity:

Press directional key (left or right) to set the sensitivity of SmartGUARD. There are five sensitivity settings (1,3,5,7,9 seconds) that can be selected. Sensitivity defines the time from when a fire is detected until the fire alarm alerts user of fire and automatically shuts down the laser from firing. For example, if the sensor delays switch is set to the 3-second position, the SmartGUARD will start an alarm and automatically stop laser firing after detecting a fire for 3 seconds.

SmartGUARD Setting Page	
Relevant Buttons	Function
F1 (Back)	Back to previous page
F4 (Save)	Save your current settings
△ / ▽ Directional	Adjust the value for that selections
◁ / ▷ Directional	Adjust the value for that selections

## 7.8 SmartAIR Fine / Ultra Nozzles Option

The SmartAIR™ Fine and Ultra Nozzles minimize flaming, suppress working temperatures, and blow away dust and particle byproducts generated from the laser process.

The SmartAIR Fine Nozzle is recommended for engraving or cutting thin material such as textile. The smaller caliber nozzle is positioned closer to the object for a concentrated blast directed over a small area to eliminate burning on the cutting edge. The vertical design of the SmartAIR Fine Nozzle produces a concentrated airflow to blow away dust and unwanted residue, leaving a clean product surface.

The SmartAIR Ultra Nozzle is recommended for cutting thick material such as acrylic. The larger caliber nozzle produces strong airflow over a wider area to prevent flaming when the laser is cutting at slower speeds.

### NOTE

- The SmartAIR Fine and Ultra air nozzles are not compatible with Spirit GLS Hybrid model.
- The Spirit Series comes standard with the SmartAIR Standard Nozzle, but for specialized jobs on specific materials, we highly recommend the use of the SmartAIR Fine or Ultra Nozzles.

### **INSTALLATION:**

- 1) Unscrew the thumbscrews securing the front plate of the laser head, and remove the faceplate.
- 2) Remove the currently installed nozzle by simply sliding it outwards (towards you).
- 3) With either the SmartAIR Fine or Ultra Nozzle, simply slide into the slot (where you removed the original nozzle), with the pointed end face down.
- 4) Position the faceplate back onto the laser head and screw the thumbscrews back into place.

### **OPERATION:**

- 1) With the air compressor unit and applicable SmartAIR Nozzle properly installed. Switch on the air compressor unit and make sure that the airflow regulator on the air assist valve is opened (turn clockwise to increase the airflow, counter-clockwise to decrease the airflow). The air nozzle under the laser head should emit a steady flow of air.
- 2) With the SmartAIR nozzle and air compressor properly installed and operating, all configurations and settings relating to air-assist functions are controlled through the LaserPro Spirit Series print driver and hardware control panel. Please refer to the LaserPro Spirit Series print driver and graphic control panel sections of this manual for details on how to enable and configure air-assist functionalities.

# 8

## Chapter 8

---

# Basic Maintenance

### Suggested Cleaning and Maintenance Supplies

#### Maintaining the Work table and Motion System

- Accessing the Work table and Motion System
- Cleaning the Work table and Motion System
- Lubrication of the Y Rails

#### Cleaning the Optics System

- Removing the Mirrors
- Cleaning the Mirrors
- Removing and Cleaning the Focal Lens

Keeping your LaserPro Spirit Series clean and well maintained will ensure quality output, consistent reliability, and extended product life. Smoke, dust or residue build-up inside the laser system or the mechanical components can cause a reduction in the laser power, irregularities in the motion system, reduced product life cycle, and a host of other avoidable problems. This section will cover how to perform regular maintenance on the work table, motion system, mirrors, and focal lens. The frequency of the cleaning schedule will depend on number of variables such as the types of material you work with, the immediate work environment, the frequency of use, the quality of the exhaust system, etc.

 <b>WARNING</b>	
<ul style="list-style-type: none"> <li>• Electrical shock may occur if you do not turn off and unplug the Spirit Series before cleaning.</li> <li>• Damage may occur to the system if you do not turn off and unplug the Spirit Series before cleaning.</li> <li>• Always turn off and unplug the Spirit Series before cleaning!</li> </ul>	

## 8.1 Suggested Cleaning and Maintenance Supplies

Cleaning / Maintenance Tool	Special notes
Soap Solution or All-Purpose Cleaner	
Paper Towels	
Cotton Cloth	
Denatured Alcohol	DO NOT use alcohol on any painted surface, plastic, or the laser system.
Acetone	ONLY to be used on the work table
Vacuum Cleaner with a Flexible Nozzle	Only to be used in and around the work table and motion system
Lubrication syringe	Supplied
Cotton Swabs	Supplied
Lens Cleaner	Supplied 1pc. Local supply is suggested.*
Lint Free Lens Tissue	Supplied
#2 Phillips Screwdriver	
Allen Wrench .050"	

\*The recommended lens cleaner is Eclipse Cleaning System Solution from Photographic Solutions or HPLC grade Methanol. Search "Eclipse Cleaning System Solution" on Amazon or eBay to get the solution locally.

<http://www.amazon.com/Photographic-Solutions-ECDCS-Cleaning-Solution/dp/B0000AUR1I>



Eclipse Cleaning System Solution

## 8.2 Maintaining the Work table and Motion System

### 8.2.1 Accessing the Work Table and Motion System

It will be important to gain full access to the work table and motion system to properly clean and maintain these areas. To do so, you will need to lift the SmartLID. You can do this via the following steps:

#### Opening the SmartLID:

- 1) The top lid of the machine can be lifted open by using the handles from the rear side of the LaserPro Spirit Series. Lift the lid to the maximum (indicated by a small click) to engage the latch (as shown in the picture below).



- 2) Manually lock the SmartLID via the two sliding locks found on each side of the metal support rails by sliding them to the locked position (as shown in the picture below).

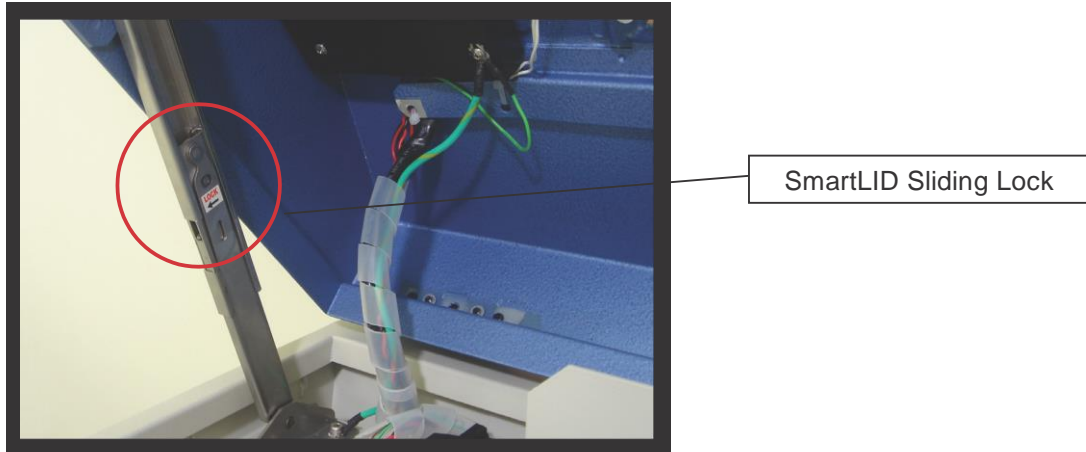

 **WARNING**

Anytime you have the SmartLID open, always make sure you have properly engaged the SmartLID manual locks on both sides of the metal support rails. Failure to do so may pose a serious risk if the SmartLID slams down.

#### Closing the SmartLID:

To properly close the SmartLID after you have finished accessing the work table or motion system, please follow these steps:

- 1) Disengage both of the sliding locks found on each side of the metal support rails by sliding them away from you and into the unlock position.
- 2) Push the SmartLID away from you and move to the maximum position to disengage the latch (indicated by a small click) and gently close the SmartLID.

#### 8.2.2 Cleaning the Work Table and Motion System

Clean the working table and the motion system on a frequent basis through the following steps:

- 1) Turn the power off and unplug the Spirit before cleaning.
- 2) Use a vacuum cleaner with a flexible nozzle to remove dust and debris from the work table and motion system.
- 3) Apply small amounts of all-purpose cleaner, alcohol, or acetone to a paper or cotton towel to clean the working table.
- 4) Apply a soap solution, all-purpose cleaner, or alcohol to a paper or cotton towel to wipe down the rails of the motion system.
- 5) Wait for all cleaning residue to dry completely before plugging in and operating the Spirit Series.

 **CAUTION**

- Never pour or spray alcohol or acetone directly to the work table.
- Oil, alcohol and acetone can cause fires or smoke build-up if improperly used.



## Tip

Please clean the AutoFocus pin each time after completing the engraved job to make sure the AutoFocus pin is free to move.

### 8.2.3 Lubrication of the X & Y Rails

In order to keep the motion system running smoothly, the X and Y rails of the motion system will need lubrication on weekly base. Apply 0.1ml of lubrication syringe in accessory box to the X liner rail of Spirit LS and Spirit GLS models on bi-week base, while apply a small amount of light grade machine oil or PS2 grease to a paper or cotton towel and apply to the X rail of Spirit model, and Y rails of Spirit, Spirit LS and Spirit GLS models weekly. You can purchase PS2 grease from NSK dealers worldwide. Please visit <http://www.nsk.com/eng/company/network/index.html> for additional information

#### NOTE

- Clean and lubricate the X linear rail of Spirit LS and GLS models with 0.1ml grease from syringe every two weeks to properly maintain the motion system.
- The lubrication oil for the X linear rail on Spirit LS and Spirit GLS must to be ordered from GCC LaserPro and its authorized dealers. Other unknown grease may damage the rail's life time and performance.
- Always clean and lubricate the X and Y rails of Spirit, and Y rails of Spirit LS & GLS models after working with materials that produce lots of debris (such as wood).
- Too much oil or PS2 grease applied to the Y rails will accelerate the debris building up.

The X rail of Spirit LS and Spirit GLS models has linear bearing design which needs lubrication regularly depending on the job loading, recommend on bi-weekly base. Follow below procedures.

1. Take out the Grease Syringe from accessory box
2. Remove the lubrication slot plate on the X rails
3. Inject 0.1ml of grease to the injection opening inside the linear bearing, and move the lens carriage to smooth the grease and movement
4. Repeat the step 3 till the grease is full out of the linear bearing
5. Repeat the step 3 and 4 to the injection opening in opposite side of the linear bearing
6. Seal the lubrication slot plate back to the X rail

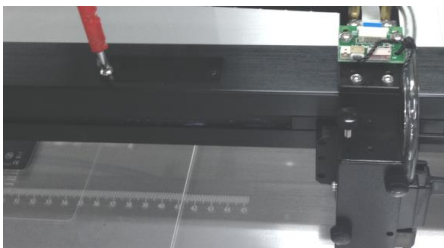

Remove the lubrication slot plate  
on X rail

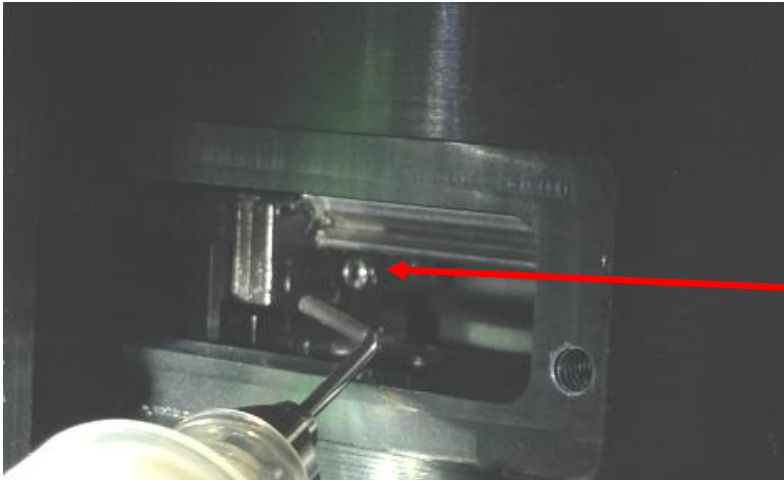

Inject small amount of grease to this injection opening inside the linear bearing

6. Open the belt by hand and use cotton swab to clean the linear guide (make sure to clean top, bottom and surface of linear guide).



7. Use clean oil on cotton swab and then grease on linear guide (including top, bottom and surface of linear guide).

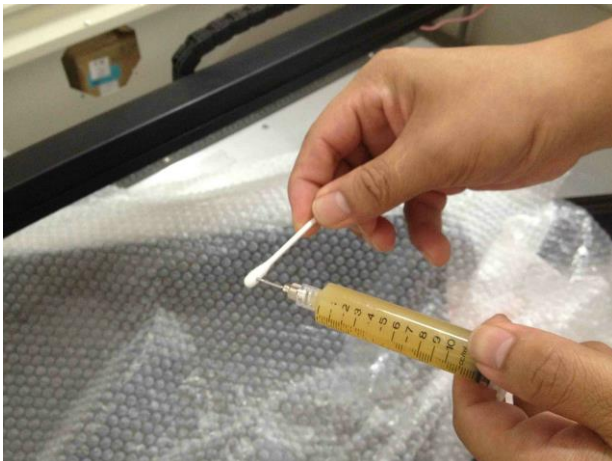



## 8.3 Cleaning the Optics System

### 8.3.1 Removing the Mirrors

We recommend that you check the mirrors once or twice a week to see if they require cleaning. If any debris or smoke residue is present, use the following steps to clean them.

#### NOTE

- Mirrors should be removed for cleaning one at a time to avoid beam misalignment after placing them back to the lens holders.
- Refer to section 8.3.2 on how to clean the mirrors.

The following section will illustrate the location of the four mirrors found on the LaserPro Spirit Series for cleaning.

#### Mirror 1

Mirror #1 is located inside the bottom left access door panel of the LaserPro Spirit Series.

- 1) Use a #2 Phillips Screwdriver to open the access panel located on the bottom left side of the LaserPro Spirit Series.
- 2) Open the slot cover on the bottom left side of Spirit Series machine

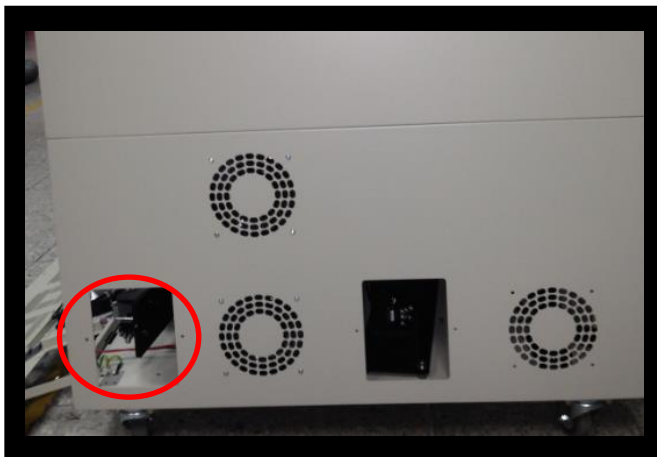

- 3) Loosen the thumbscrew and remove the black dust cover in front of laser tube.

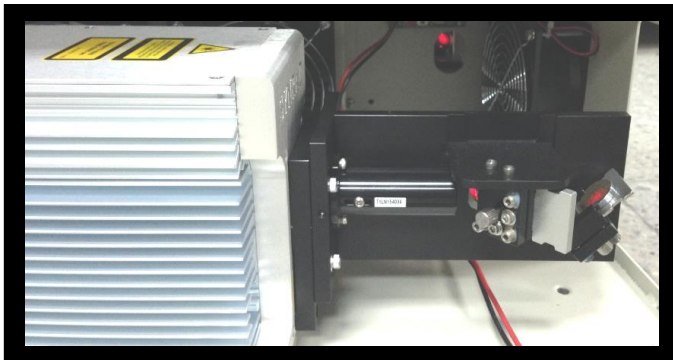

- 4) Loosen the thumbscrew securing mirror #1.

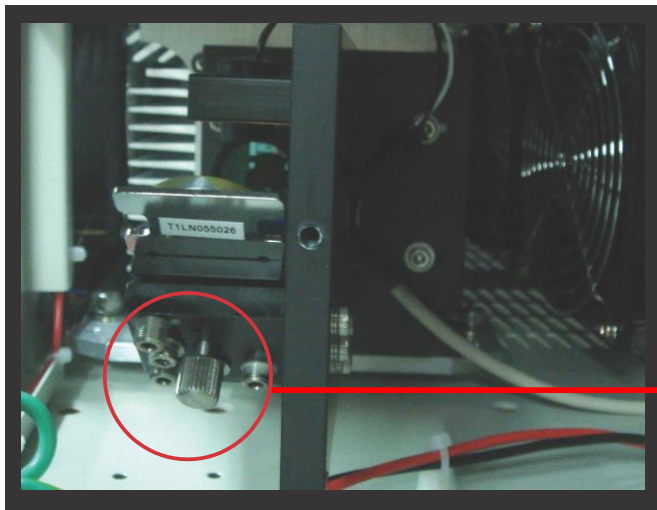

Thumbscrew

- 4) Clean the mirror in the proper manner.
- 5) Place the mirror back to the optics holder after cleaning.
- 6) Tighten the thumbscrew.
- 7) Close and secure all the covers.

For Spirit GLS Hybrid machine equipped with dual laser tubes (CO2 laser tube and Fiber laser tube), in addition to above mentioned process to access and clean mirror #1, there is an extra mirror #1 for fiber laser module needs maintenance.

- 1) Open slot cover located at bottom left side of the machine

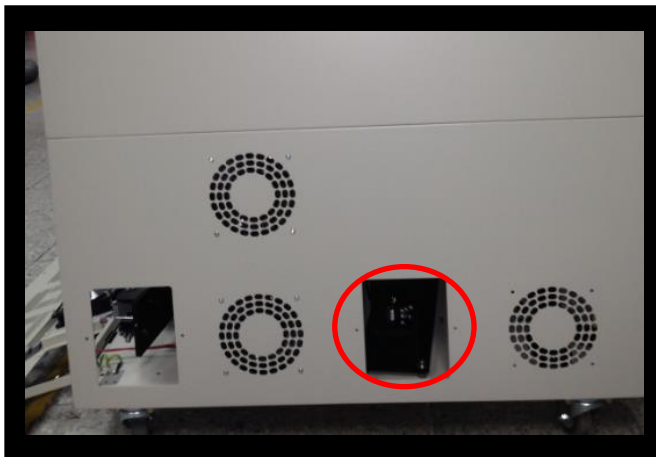

- 2) Loosen the thumbscrew and remove the black dust cover in front of laser tube.
- 3) Loosen the thumbscrew secured the mirror #1.
- 4) Clean the mirror in the proper manner.
- 5) Place the mirror back to the optics holder after cleaning.
- 6) Tighten the thumbscrew.
- 7) Close and secure all the covers.

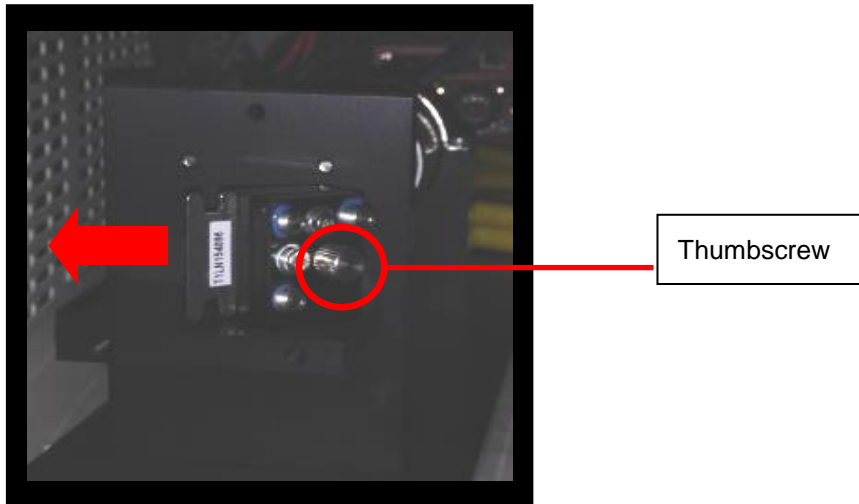

### Mirror 2, 3, 4

These mirrors are located in the work table area of the LaserPro Spirit Series.

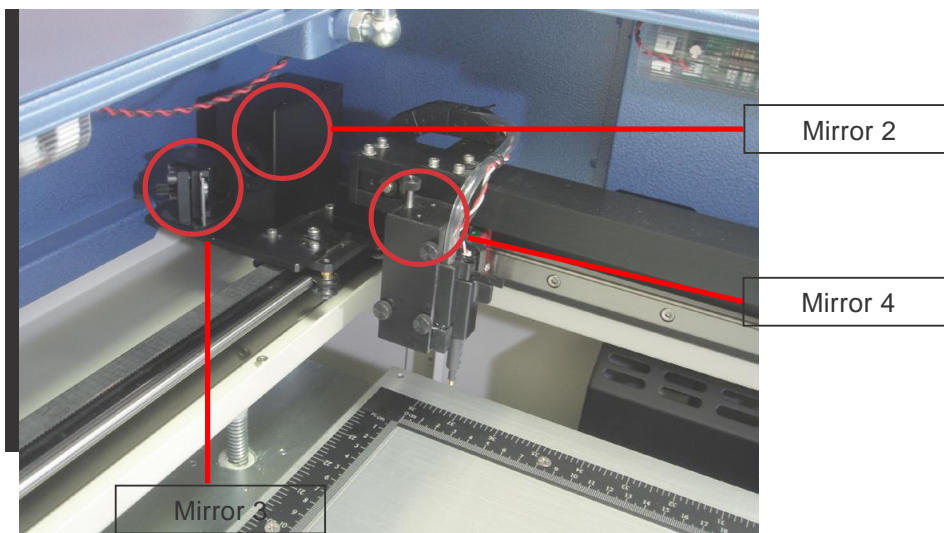

### Mirror 2

- 1) Unscrew and remove the black dust cover covering mirror 2.
- 2) Unscrew the thumbscrew holding mirror 2 in place.
- 3) Clean the lens in the proper manner.
- 4) Place the mirror back to the optics holder after cleaning.
- 5) Tighten the thumbscrew.
- 6) Close and secure the black dust cover.

### Mirror 3

- 1) Unscrew the thumbscrew holding mirror 3 in place.
- 2) Clean the lens in the proper manner.
- 3) Place the mirror back to the optics holder after cleaning.
- 4) Tighten the thumbscrew.

## Mirror 4

- 1) Unscrew the three thumbscrews securing the lens carriage panel and remove the lens carriage panel to reveal mirror 4 and the focal lens.
- 2) Loosen the top thumbscrew to remove mirror 4 (as shown in the picture below).

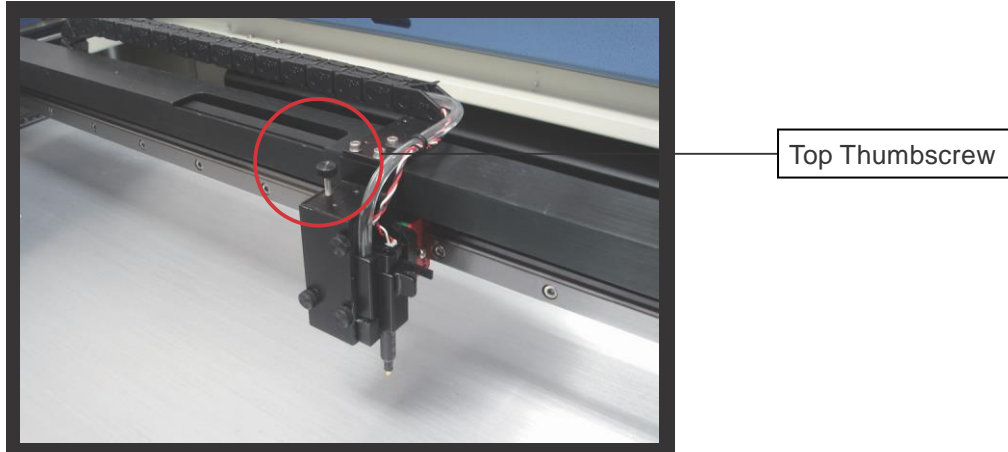

- 3) Clean the lens in the proper manner.
- 4) Place the mirror back to the optics holder after cleaning.
- 5) Tighten the top thumbscrew.
- 6) Reinstall the lens carriage panel and tighten the three thumbscrews.

### 8.3.2 Cleaning the Mirrors

After you have removed each mirror, you will want to inspect each mirror for scratches, smoke residue, or debris. If any residue or debris is present, use the following steps to clean the mirrors.

- 1) Hold the mirror with the reflective side up, without touching the reflective side of the mirror **(DO NOT apply any finger pressure or any other cleaning solutions to the mirror surface)**.
- 2) Drape a new sheet of lens tissue over the mirror.
- 3) Apply a few drops of lens cleaner on the tissue covered mirror (apply enough so that the tissue absorbs just enough solution to cover the mirror surface).
- 4) Pull the tissue across the mirror in only one direction.
- 5) Repeat the cleaning processes if the mirror is not completely clean after the first attempt.
- 6) Make sure that the mirror is completely dry before reinstalling it.





## CAUTION

- If the center of the mirror is scratched, contact your GCC LaserPro representatives for replacement.
- **DO NOT apply any finger pressure or any other cleaning solutions to the mirror or focal lens surface.**
- The optics components are very fragile, handle carefully and follow the cleaning procedure well.

### 8.3.3 Removing and Cleaning the Focal Lens

- 1) Unscrew the three thumbscrews securing the lens carriage panel and remove the lens carriage panel to reveal the focal lens.
- 2) Carefully pull out the focal lens.
- 3) Clean the focal lens with a cotton swab and lens cleaner solution. Be sure to clean both sides of the focal lens **(DO NOT apply any finger pressure or other cleaning solutions to the lens surface).**
- 4) After cleaning, use a cotton swab to gently dry the focal lens and lens cover.



Remove thumbscrew



Pull out the focal lens

## 8.4 Cleaning the Exhaust Duct

Efficient exhaust ventilation is crucial to laser cutting quality. We suggest you to clean the Exhaust Duct from accumulated dust regularly will help to maintain the ventilation efficiency of your laser engraving system.

Step 1. Remove screws fixing the rear door panel of laser machine

Step 2. Remove screws securing exhaust duct on rear door panel

Step 3. Open the rear door and take out the exhaust duct to clean with water

Step 4. Fix and secure the exhaust duct and rear door panel back to the laser machine



Remove screws securing rear door and exhaust duct



Take out the exhaust duct and clean with water

# 9

Chapter 9

---

## Basic Troubleshooting

## Quality Problems

- Check focal length setting under F4 function key Machine Setting Set Focus Lens to see if it matches the type of the lens installed.
- Check if the focal lens is installed correctly or if focal lens is not fixed properly.
- Check if it is caused by the debris or dust builds up in the bearing tracks of X rail.
- Check if it is caused from the damaged or dirty focal lens and mirror 4 in the lens carriage which can not deliver the laser beam effectively.

## Non-operational Problems

- Laser does not fire
  1. If the red alignment beam is not visible, the laser beam may be misaligned. Adjust the reflection mirrors for exact focus.
  2. If the red alignment beam is visible, please check the driver power. The laser power may be set to too low for detection. Increase the percentage setting of the Laser Power from the software driver or the control panel.
  3. Check if the laser power connector is connected.
  4. For safety purposes, the laser will not fire when the top lid or the front door is open unless the door sensors are defeated by shorting them with magnets.
  5. Check water level or temperature of water cooler if the equipped laser requires water cooling. The laser tube will automatically shut down itself if the laser tube is over-heated.

### NOTE

Unplug the machine before examining the mirrors, lens, motion system or any other part of the laser system.

## Other Problems

- "Graphic Was Clipped..." Message  
The size or location of graphic image may be bigger or beyond the legal working area. Do not place graphic object, especially vectors, right from (3,0) origin position, or 0 at either x or y rail of working area on application software. Take Corel Draw for instance, even when the vector line's width has been set to the thinnest, it may still go beyond the border and causes the error. If the message appears randomly but frequently even image object is smaller or within the legal border, check or change DRAM module, a bad contact or faulty DRAM could cause such error.
- Auto Focus Pin is Not Functioning  
The focus pin could be stocked by greasy residue that gradually forms a coating. Clean the probe with alcohol or acetone. Check the cable of focus pin, there might be a bad contact or breakage.



# 10

Chapter 10

---

## Appendix

Glossary

LaserPro Spirit Series Specification Sheet

## 10.1 Glossary

**Color Fill** – Term within the awards and engraving industry used to describe the variety of techniques used to add color or contrast to engraving.

**DPI** – Dots Per Inch or Pixels Per Inch. The resolution of an image is defined by the amount of dots/pixels included in an inch. The DPI setting of 500, will tell the machine to include 500 laser firings within an inch.

**Driver** – A software program that allows the computer to communicate with its components and peripherals: printers, scanners, monitors, etc.

**Error Diffusion (Dithering Method)** - This effect uses a series of random black and white pixels to represent shading.

**Firmware** – Programming permanently set into a computer's ROM chips. This information is burned into the computer chips and can only be changed by replacing the chips, or in the case of EEROM, by special procedure.

**PPI** – Pulses Per Inch. PPI determines the gross amount of laser pulses there will be per linear inch. PPI is exclusively used for the vector setting. A PPI setting of 500 results in the laser firing every .002" (500 times per inch). If the standard lens is producing a vector laser focal point of .007", then higher PPI settings will result in deeper, overlapping laser pulses. PPI settings lower than 150 will result in the individual laser pulses being spread far apart, so they will not touch each other. Low PPI settings are a good example of perforate paper.

**Raster** – The process of rendering a cutting or engraving by multiple horizontal lines. For example: when cutting out or engraving a square, the raster setting will make the laser use numerous horizontal lines to fill in the outlined space.

**Raster Image** – An image that is defined as a collection of arranged pixels in a rectangular array of lines. A raster image is similar to a "Bitmap" graphics image.

**Raster Line** – A raster line is the individual horizontal line that makes up the raster image.

**Serial Port** – A connection that allows a computer to send data to a peripheral device one bit at a time.

Usually it is a COM port that meets the RS232C specification.

**Vector** – The process of cutting or engraving an image by using single horizontal, vertical and curved lines. For example: when cutting out or engraving the outline of a square, the vector setting will make the laser use a thin single line to follow the outline of the shape.

## 10.2 LaserPro Spirit Series Specification Sheet

<b>Spirit</b>		
Work Area		25 x18 in. (640 mm x 460 mm) Extendable to 29x18 in. (740 x 460 mm)
Max. Part Size (W x L x H)	All doors closed	30 x 19 x 6.5 in. (762 x 482.6 x 165 mm)
	All doors open	30 x ∞ x 6.5 in. (762 x ∞ x 165 mm)
Table Size		31.1 x 20.9 in. (790 x 530 mm)
Dimensions (W x L x H)		44.3 x 28.3 x 39.6 in. (1125 x 720 x 1005 mm)
Laser Source		12 to 100W 10.6µm sealed CO2 Laser/ 20W & 60W 9.3µm sealed CO2Laser
Cooling		Air-cooled, Operating environment temperature 15°- 30°C (60° - 86°F)
Drive		Closed-loop DC Servo control
Maximum Motor Speed		60 IPS
Throughput**		245.5 in <sup>2</sup> / hr (1584 cm <sup>2</sup> / hr)
Throughput** with SmartACT		283.4 in <sup>2</sup> / hr (1828.8 cm <sup>2</sup> / hr)
Speed Control		Adjustable from 0.1-100% of 60IPS (Up to 16 color-linked speed settings per job)
Power Control		Available from 0-100% (UP to 16 colors linked power setting per job)
Distance Accuracy		0.254mm or 0.1% of move, whichever is greater
Z-Axis Movement		Automatic
Focus lens		Standard 2.0", optional 1.5", 2.5" & 4.0" available
Resolution (DPI)		Available 125, 250, 300, 380, 500, 600, 760, 1000, 1500
Computer Interface		Full speed 2.0 USB, 10 Base-T Ethernet
Memory Buffer		32MB standard
Compatible Operating Systems		MS Windows
Display Panel		4-line LCD panel showing current file name, total working time, laser power, engraving speed, file(s) loaded into memory buffer, setup and diagnostic menus
Safety		Class I Laser Product Compliant with EN60825 Class II Laser Product Compliant with CDRH 2006/42/EC Machinery Directive Compliance
Operation Voltage		Laser below 80Watt, 100-240VAC, 50-60Hz Auto Switching, Max. 15A

	Laser 80Watt and above, 200-240VAC, 50-60Hz, Max. 15A
Fume Extraction System	External exhaust system is required, one 4 in. connection on the back of the machine

<b>Spirit LS Series</b>	
Work Area	25 x 18 in. (640 x 460 mm) Extendable to 29 x 18 in. (740 x 460 mm)
Max. Part Size (W x L x H)	All doors closed 30 x 19 x 6.5 in. (762 x 482.6 x 165 mm)
	All doors open 30 x ∞ x 6.5 in. (762 x ∞ x 165 mm)
Table Size	31.1 x 20.9 in. (790 x 530 mm)
Dimensions (W x L x H)	44.3 x 28.3 x 39.6 in. (1125 x 720 x 1005 mm)
Laser Source	12 to 100W 10.6-μm sealed CO2 Laser / 20W & 60W 9.3-μm sealed CO2 Laser
Cooling	Air-cooled, Operating environment temperature 15°-30°C (60°-86°F)
Drive	Closed-loop DC servo control
Maximum Motor Speed	80 IPS*
Throughput**	260.9 in <sup>2</sup> / hr (1683 cm <sup>2</sup> / hr)
Throughput**with SmartACT™	322.1 in <sup>2</sup> / hr (2078 cm <sup>2</sup> / hr)
Speed Control	Adjustable from 0.1-100% (Up to 16 color-linked speed settings per job)
Power Control	Adjustable from 0-100% (Up to 16 color-linked power settings per job)
Distance Accuracy	0.254 mm or 0.1% of move, whichever is greater
Z-Axis Movement	Automatic
Focus lens	Standard 2.0", optional 1.5", 2.5", & 4.0" available
Resolution (DPI)	Available 125, 250, 300, 380, 500, 600, 760, 1000, 1500
Computer Interface	Full speed 2.0 USB, 10 Base-T Ethernet
Memory Buffer	32MB standard
Compatible Operating Systems	MS Windows
Display Panel	4-line LCD display showing current file name, total working time, laser power, engraving speed, file(s) loaded into memory buffer, setup and diagnostic menus
Safety	Class I Laser Product Compliant with EN60825

	Class II Laser Product Compliant with CDRH 2006/42/EC Machinery Directive Compliance
Facility Requirements	
Operation Voltage	Laser below 80Watt, 100-240VAC, 50-60Hz Auto Switching, Max. 15A Laser 80Watt and above, 200-240VAC, 50-60Hz Auto Switching, Max. 15A
Fume Extraction System	External exhaust system is required, one 4 in. connection on the back of the machine

\* The max. motor speed for Spirit LS 12W and 25W models is 60IPS, and 80IPS for 30W and above models.

<b>Spirit GLS</b>		
Work Area	34 x 24 in. (860 x 610 mm) Extendable to 38 x 24 in. (960 x 610 mm)	
Max. Part Size (W x L x H)	All doors closed	39 x 25 x 7 in. (990 x 635 x 177 mm)
	All doors open	39 x ∞ x 7 in. (990 x ∞ x 177 mm)
Table Size	40.3 x 27.7 in. (1025 x 705 mm)	
Dimensions (W x L x H)	53.7 x 34.6 x 39.7 in. (1365 x 880 x 1010 mm)	
Laser Source	10.6-μm CO2 laser 30 to 100W/ 9.3-μm sealed CO2 laser 20W & 60W	
Cooling	Air-cooled, Operating environment temperature 15°-30°C (60°-86°F)	
Drive	Closed-loop DC Servo Control	
Maximum Motor Speed	80 IPS	
Throughput**	260.9 in <sup>2</sup> / hr (1683 cm <sup>2</sup> / hr)	
Throughput* with SmartACT™	322.1 in <sup>2</sup> / hr (2078 cm <sup>2</sup> / hr)	
Speed Control	Adjustable from 0.1~100% (Up to 16 color-linked speed settings per job)	
Power Control	Adjustable from 0~100% (Up to 16 color-linked power settings per job)	
Distance Accuracy	0.254 mm or 0.1% of move, whichever is greater	
Z-Axis Movement	Automatic	
Focus Lens	standard 2.0", optional 1.5", 2.5", 4.0"	
Resolution (DPI)	Available 125, 250, 300, 380, 500, 600, 760, 1000, 1500	
Computer Interface	Full speed 2.0 USB, 10 Base-T Ethernet	
Memory Buffer	32MB standard	
Compatible Operating Systems	MS Windows	

Display Panel	4-line LCD display showing current file name, total working time, laser power, engraving speed, file(s) loaded into memory buffer, setup and diagnostic menus
Safety	Class I Laser Product Compliant with EN60825 Class II Laser Product Compliant with CDRH 2006/42/EC Machinery Directive Compliance
Facility Requirements	
Operation Voltage	Laser below 80Watt, 100-240VAC, 50-60Hz Auto Switching, Max. 15A; Laser 80Watt and above, 200-240VAC, 50-60Hz Auto Switching, Max. 15A
Fume Extraction System	External exhaust system is required, one 4" connection on the back of the machine

\*\* Speed is not equal to throughput. See dealer or visit [www.gccworld.com](http://www.gccworld.com) for more details.

Specifications are subject to change without prior notice.

<b>Spirit GLS Hybrid</b>		
Work Area	34 x 24 in. (860 x 610 mm) Extendable to 38 x 24 in. (960 x 610 mm)	
Max. Part Size (W x L x H)	All doors closed	39 x 25 x 7 in. (990 x 635 x 177 mm)
	All doors open	39 x ∞ x 7 in. (990 x ∞ x 177 mm)
Table Size	40.3 x 27.7 in. (1025 x 705 mm)	
Dimensions (W x L x H)	53.7 x 34.6 x 39.7 in. (1365 x 880 x 1010 mm)	
Laser Source	10.6-μm CO2 laser: 30 to 100W	
	fiber laser: 20W~60W	
Cooling	Air-cooled, Operating environment temperature 15°-30°C (60°-86°F)	
Drive	Closed-loop DC Servo Control	
Maximum Motor Speed	80 IPS	
Throughput**	260.9 in <sup>2</sup> / hr (1683 cm <sup>2</sup> / hr)	
Throughput* with SmartACT™	322.1 in <sup>2</sup> / hr (2078 cm <sup>2</sup> / hr)	
Speed Control	Adjustable from 0.1~100% (Up to 16 color-linked speed settings per job)	
Power Control	Adjustable from 0~100% (Up to 16 color-linked power settings per job)	
Distance Accuracy	0.254 mm or 0.1% of move, whichever is greater	

Z-Axis Movement	Automatic
Focus Lens	standard 2.0"
Resolution (DPI)	Available 125, 250, 300, 380, 500, 600, 760, 1000, 1500
Computer Interface	Full speed 2.0 USB, 10 Base-T Ethernet
Memory Buffer	32MB standard
Compatible Operating Systems	MS Windows
Display Panel	4-line LCD display showing current file name, total working time, laser power, engraving speed, file(s) loaded into memory buffer, setup and diagnostic menus
Safety	Class I Laser Product Compliant with EN60825 Class 3R Laser Product Compliant with CDRH 2006/42/EC Machinery Directive Compliance
Facility Requirements	
Operation Voltage	Laser below 80Watt, 100-240VAC, 50-60Hz Auto Switching, Max. 15A; Laser 80Watt and above, 200-240VAC, 50-60Hz Auto Switching, Max. 15A
Fume Extraction System	External exhaust system is required, one 4" connection on the back of the machine

\*\* Speed is not equal to throughput. See dealer or visit [www.gccworld.com](http://www.gccworld.com) for more details.

Specifications are subject to change without prior notice.